

Shutters/Blinds Actuator CJAU-01/04..

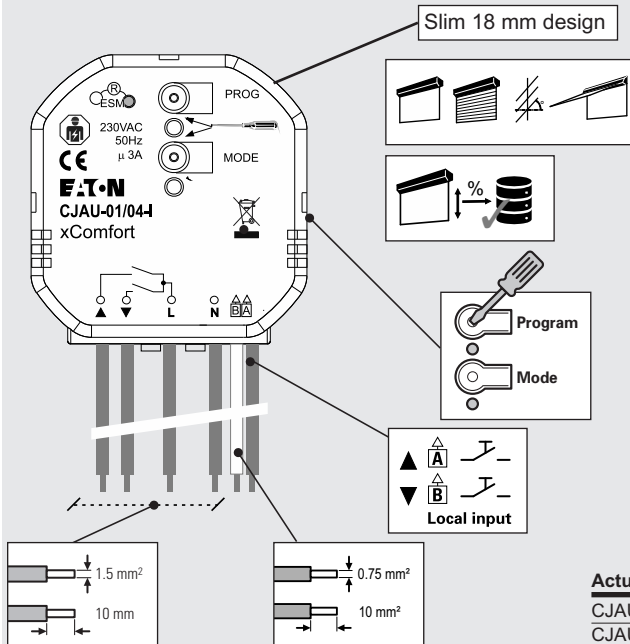

| Actuator | Type |
|--------------|------------------|
| CJAU-01/04 | |
| CJAU-01/04-I | With local input |

Technical Data / Technische gegevens / Tekniske data / Technische Daten / Technická data

| | |
|----------------------------------|---|
| Power supply | 230 VAC +10% -15%, 50 Hz |
| Load | 3 A, L/R |
| Power standby | < 200 mW (Typical) |
| Local input | 230 VAC (Max. 265 V) |
| Input contact resistance IN to L | < 10 kΩ reliably ON > 50 kΩ reliably OFF |
| Voltage difference IN to L | < 1 V reliably ON > 3 V reliably OFF |
| Protection | Overload, Over-temperature |
| Dimensions | 49.5 x 45.5 x 18 mm (H x W x D) |
| RF | 868,3MHz (xComfort compatible) |
| Max RF power | 25mW (ERP) |

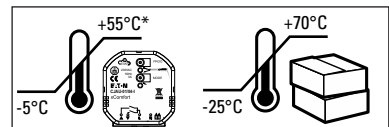

| MRF | Version 2.80 |
|-----------------|---------------|
| RM | Version: 41a |
| SHC-RF | Version: 2.00 |
| ECI-RF | Version: 2.00 |
| USB-RF | Version: 2.00 |
| xComfort Bridge | Version: 3.10 |



www.eaton.com/xcomfort



CJAU-01/04

CJAU-01/04-I

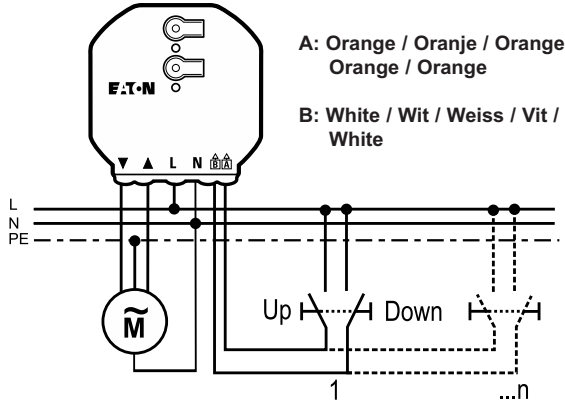
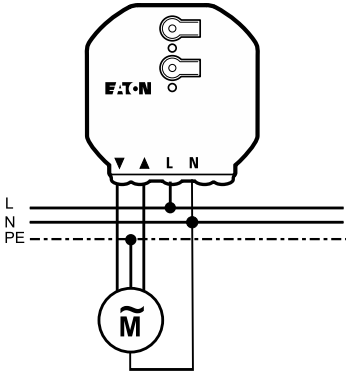

A: Orange / Oranje / Orange / Orange / Orange

B: White / Wit / Weiss / Vit / White

Basic mode

Assign Sensor in Basic Mode / Sensor in Basic Mode toewijzen / Tilknytte i Basic Mode / Zuweisen im Basic Mode / Přiradit v základním režimu

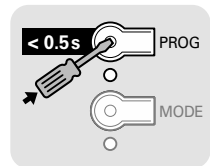
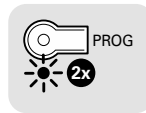
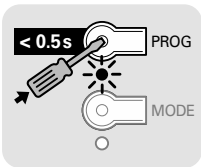

Remove Sensor in Basic Mode // Sensor in Basic Mode verwijderen / Fjerne i Basic Mode / Löschen im Basic Mode / Odstranit v základním režimu

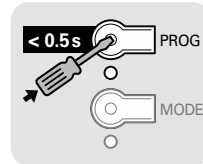
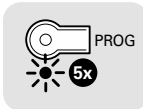
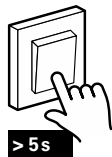
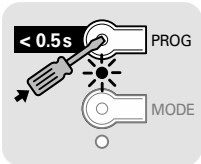

Configure application mode / Toepassingsmodus configureren / Konfigurer applikasjonsmodus / Anwendungsmodus konfigurieren / Konfigurace režimu aplikace

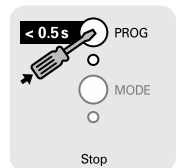
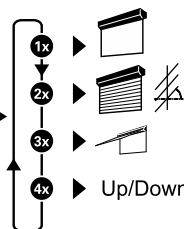
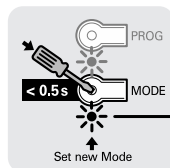
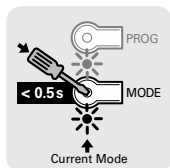
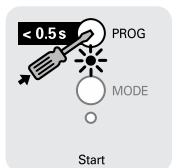

Identify in MRF /
Identificeren in MRF /
Identiser i MRF /
Identifizieren im MRF /
Identifikace v MRF

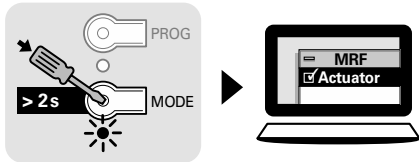

Back to factory default /
Terug naar fabrieksinstellingen /
Tilbake til fabrikkinnstillinger /
Auf Auslieferungszustand zurücksetzen /
Zpět na tovární hodnoty

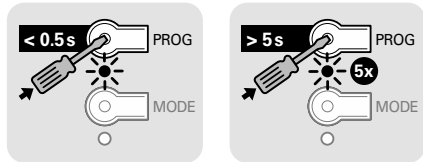



Declaration of Conformity

We, EATON Industries (Austria) GmbH
3943 Schrems, Eugenia 1
Austria

declare under our sole responsibility as manufacturer that the product (family)

Eaton - Shutters / Blinds Actuator UP

CJAU-01/04..

(the declaration of conformity applies to all listed types within our actual product catalogue)

provided that it is installed, maintained and used in the application intended for, with respect to the relevant manufacturer's instructions, installation standards and "good engineering practices"

complies with the provisions of Council directive(s):

RED Directive 2014/53/EU

RoHS Directive 2011/65/EU + 2015/863

based on compliance with following standard(s):

EN 300220-2 V3.2.1, EN 301489-3 V2.1.1, EN 301 489-1 V2.2.3, EN IEC 63044-5-1:2019, EN IEC 63044-5-2:2019, EN IEC 63044-5-3:2019, EN 60669-2-5:2016, EN 63000:2018



Schrems, 11.11.2021

Gerhard Dischner

Director Operations

Friedrich Schröder

Director Quality

Affixing date of CE mark: 2021

Doc.Id.: CJAU_01-04_11112021

