

**Digital output module XI/ON, 24 V DC, 2DO, 2A, pulse-switching**

**Part no. XN-2DO-24VDC-2A-P**  
**Article no. 140055**



## Delivery program

Function			XI/ON I/O modules
Function			XN Slice module
Short Description			2 Digital output, 24 V DC/2 A Positive switching
For use with			XN-S3T-SBC XN-S3S-SBC XN-S4T-SBCS XN-S4S-SBCS

## Technical data

### General



Standards				EN 61000-6-2 EN 61000-6-4 EN 61131-2
Potential isolation				Yes, through optocoupler
Ambient temperature				
Ambient temperature, operation		°C		0 - +55
Storage, transport	ø	°C		-25 - +85
Relative humidity				
Relative humidity				5 - 95 % (indoor), Level RH-2, no condensation (for storage at 45°C)
Ambient conditions, mechanical				
Degree of Protection				IP20
Harmful gases		ppm		SO <sub>2</sub> : 10 (rel. humidity < 75%, no condensation) H <sub>2</sub> S: 1.0 (rel. humidity < 75 %,no condensation)
Vibration resistance, operating conditions				according to IEC/EN 60068-2-6
Mechanical shock resistance		g		according to IEC 60068-2-27
Continuous shock resistance (IEC/EN 60068-2-29)				According to IEC 60068-2-29
Drop and topple				According to IEC 60068-2-31, free fall according to IEC 60068-2-32
Electromagnetic compatibility (EMC)				
ESD	Air/contact discharge	kV		EN 61100-4-2
Electromagnetic fields	(0.08...1) / (1,4...2) / (2...2,7) GHz	V/m		EN 61100-4-2
Burst				EN 61100-4-4
Surge				EN 61100-4-5
Radiated RFI		V		EN 61100-4-6
Emitted interference (radiated, high frequency)	(30...230 MHz) / (230...1000 MHz)	dB		EN 55016-2-3
Voltage fluctuations/voltage dips				EN 61131-2
Type test				to EN 61131-2
Approvals				CE, cULus
Other technical data (sheet catalogue)				Technical Data

### Analog input modules



Channels		Number	2
----------	--	--------	---

Rated voltage through supply terminal	$U_L$		24 V DC
Rated current consumption from supply terminal	$I_L$	mA	50
Rated current consumption from module bus	$I_{MB}$	mA	 33
Connectable sensors			Resistive loads Inductive loads Lamp loads
Diagnostics			2
Diagnostics			Yes

### Analog output modules

Channels		Number	2
Rated voltage through supply terminal	$U_L$		24 V DC
Rated current consumption from supply terminal	$I_L$	mA	50
Rated current consumption from module bus	$I_{MB}$	mA	 33
Load resistance			
Resistive load		$\Omega$	 12
Inductive load		h	1.2

### Digital outputs

Channels		Number	2
Rated voltage through supply terminal	$U_L$		24 V DC
Rated current consumption from the supply terminal (at load current = 0 mA)	$I_L$	mA	50
Rated current consumption from module bus	$I_{MB}$	mA	 33
Power loss	P	W	Normally 1
Output voltage			
High level	$U_H/U_A$		$> U_L - 1$ V DC
Output current		A	
High level (rated value)	$I_H$		2.0 A600
High level (permissible range)	$I_H$	A	$< 2.4$
Module total current		A	4
Delay on signal change and resistive load			
from Low to High level		$\mu s$	100
From High to Low signal		$\mu s$	100
Load resistance range			$< 12 \Omega$
Utilization factor	%	g	100
Can be connected			Resistive loads Inductive loads Lamp loads
Resistive load		$\Omega$	 12
Inductive load		h	1.2
Lamp load	$R_{LL}$	W	 6
Switching frequency			
With resistive load	f	Hz	5000 ( $R_{L0} < 1$ k $\Omega$ )
with inductive load			$< 2$
Switching frequency with lamp load	f	Hz	10
Number of diagnostic bytes			2
Diagnostics			Yes
Outputs to EN 61131-2			Protected
Reset after short-circuit rectified	$I_i$		Automatic
Base modules			
with C connection			2-wire/3-wire XN-S3x-SBC 4-wire XN-S4x-SBCS

### Digital inputs

Channels		Number	2
Rated voltage through supply terminal	$U_L$		24 V DC

Rated current consumption from supply terminal	$I_L$	mA	50
Rated current consumption from module bus	$I_{MB}$	mA	 33
Input voltage			
High level	$U_{eH}$	V	min. L+ (1 V)
Base modules			
with C connection			2-wire/3-wire XN-S3x-SBC 4-wire XN-S4x-SBCS

### Relay modules

Rated voltage through supply terminal	$U_L$		24 V DC
Rated current consumption from supply terminal	$I_L$	mA	50
Rated current consumption from module bus	$I_{MB}$	mA	 33
Power loss	P	W	Normally 1
Can be connected			Resistive loads Inductive loads Lamp loads
Utilization factor	g	%	100
Base modules			
with C connection			2-wire/3-wire XN-S3x-SBC 4-wire XN-S4x-SBCS

### Power supply module

Rated voltage through supply terminal	$U_L$		24 V DC
Rated current consumption from supply terminal	$I_L$	mA	50
Rated current consumption from module bus	$I_{MB}$	mA	 33
Diagnostics			2
Power loss	P	W	1

### Counter module

Channels		Number	2
Rated voltage through supply terminal	$U_L$		24 V DC
Rated current consumption from supply terminal	$I_L$	mA	50
Rated current consumption from module bus	$I_{MB}$	mA	 33

### Digital inputs

Input voltage			
High level	$U_{eH}$	V	min. L+ (1 V)

### Digital outputs

Output current		A	
High level (permissible range)	$I_H$	A	< 2.4
High level (rated value)	$I_H$		2.0 A600
Switching frequency			
with resistive load		Hz	5000
Inductive load		Hz	2
Switching frequency with lamp load	f	Hz	10
Lamp load	$R_{LL}$	W	 6
Short-circuit rating			Protected

### Measuring modes

Diagnostics			2
-------------	--	--	---

### Interfaces

Rated voltage through supply terminal	$U_L$		24 V DC
Rated current consumption from supply terminal	$I_L$	mA	50
Rated current consumption from module bus	$I_{MB}$	mA	 33
Power loss	P	W	Normally 1
Number of diagnostic bytes			2

### Notes

The supply terminal ( $U_L$ ) provides power for the module electronics and for the consumers at the outputs. The total current required for each module consists of the sum of all partial currents.

Part of the XI/ON module's electronics is supplied with module bus voltage (5 V DC), the other part through the supply terminal ( $U_L$ ).

To increase the maximum output current to up to 1 A, two outputs can be connected in parallel.

Note for table header

The rated current from supply terminal data apply at zero load current.

Applies for resistive load:  $RLO < 1k\Omega$

## Design verification as per IEC/EN 61439

Technical data for design verification			
Rated operational current for specified heat dissipation	$I_n$	A	0
Heat dissipation per pole, current-dependent	$P_{vid}$	W	0
Equipment heat dissipation, current-dependent	$P_{vid}$	W	0
Static heat dissipation, non-current-dependent	$P_{vs}$	W	1
Heat dissipation capacity	$P_{diss}$	W	0
Operating ambient temperature min.		°C	0
Operating ambient temperature max.		°C	55
Degree of Protection			IP20
IEC/EN 61439 design verification			
10.2 Strength of materials and parts			
10.2.2 Corrosion resistance			
Meets the product standard's requirements.			
10.2.3.1 Verification of thermal stability of enclosures			
Meets the product standard's requirements.			
10.2.3.2 Verification of resistance of insulating materials to normal heat			
Meets the product standard's requirements.			
10.2.3.3 Verification of resistance of insulating materials to abnormal heat and fire due to internal electric effects			
Meets the product standard's requirements.			
10.2.4 Resistance to ultra-violet (UV) radiation			
Meets the product standard's requirements.			
10.2.5 Lifting			
Does not apply, since the entire switchgear needs to be evaluated.			
10.2.6 Mechanical impact			
Does not apply, since the entire switchgear needs to be evaluated.			
10.2.7 Inscriptions			
Meets the product standard's requirements.			
10.3 Degree of protection of ASSEMBLIES			
Meets the product standard's requirements.			
10.4 Clearances and creepage distances			
Meets the product standard's requirements.			
10.5 Protection against electric shock			
Does not apply, since the entire switchgear needs to be evaluated.			
10.6 Incorporation of switching devices and components			
Does not apply, since the entire switchgear needs to be evaluated.			
10.7 Internal electrical circuits and connections			
Is the panel builder's responsibility.			
10.8 Connections for external conductors			
Is the panel builder's responsibility.			
10.9 Insulation properties			
10.9.2 Power-frequency electric strength			
Is the panel builder's responsibility.			
10.9.3 Impulse withstand voltage			
Is the panel builder's responsibility.			
10.9.4 Testing of enclosures made of insulating material			
Is the panel builder's responsibility.			
10.10 Temperature rise			
The panel builder is responsible for the temperature rise calculation. Eaton will provide heat dissipation data for the devices.			
10.11 Short-circuit rating			
Is the panel builder's responsibility.			
10.12 Electromagnetic compatibility			
Is the panel builder's responsibility.			
10.13 Mechanical function			
The device meets the requirements, provided the information in the instruction leaflet (IL) is observed.			

## Technical data ETIM 6.0

PLC's (EG000024) / Fieldbus, decenter. periphery - digital I/O module (EC001599)			
Electric engineering, automation, process control engineering / Control / Field bus, decentralized peripheral / Field bus, decentralized peripheral - digital I/O module (ecl@ss8.1-27-24-26-04 [BAA055011])			
Supply voltage AC 50 Hz		V	0 - 0
Supply voltage AC 60 Hz		V	0 - 0
Supply voltage DC		V	18 - 30
Voltage type of supply voltage			DC
Number of digital inputs			0
Number of digital outputs			2
Digital inputs configurable			No

Digital outputs configurable		No
Input current at signal 1	mA	0
Permitted voltage at input	V	0 - 0
Type of voltage (input voltage)		DC
Type of digital output		-
Output current	A	2
Permitted voltage at output	V	0 - 29
Type of output voltage		DC
Short-circuit protection, outputs available		No
Number of HW-interfaces industrial Ethernet		0
Number of HW-interfaces PROFINET		0
Number of HW-interfaces RS-232		0
Number of HW-interfaces RS-422		0
Number of HW-interfaces RS-485		0
Number of HW-interfaces serial TTY		0
Number of HW-interfaces parallel		0
Number of HW-interfaces Wireless		0
Number of HW-interfaces other		1
With optical interface		No
Supporting protocol for TCP/IP		No
Supporting protocol for PROFIBUS		Yes
Supporting protocol for CAN		Yes
Supporting protocol for INTERBUS		No
Supporting protocol for ASI		No
Supporting protocol for KNX		No
Supporting protocol for MODBUS		No
Supporting protocol for Data-Highway		No
Supporting protocol for DeviceNet		Yes
Supporting protocol for SUCONET		No
Supporting protocol for LON		No
Supporting protocol for PROFINET IO		No
Supporting protocol for PROFINET CBA		No
Supporting protocol for SERCOS		No
Supporting protocol for Foundation Fieldbus		No
Supporting protocol for EtherNet/IP		No
Supporting protocol for AS-Interface Safety at Work		No
Supporting protocol for DeviceNet Safety		No
Supporting protocol for INTERBUS-Safety		No
Supporting protocol for PROFIsafe		No
Supporting protocol for SafetyBUS p		No
Supporting protocol for other bus systems		Yes
Radio standard Bluetooth		No
Radio standard WLAN 802.11		No
Radio standard GPRS		No
Radio standard GSM		No
Radio standard UMTS		No
IO link master		No
System accessory		Yes
Degree of protection (IP)		IP20
Type of electric connection		Plug-in connection
Time delay at signal exchange	ms	0 - 0.1
Fieldbus connection over separate bus coupler possible		Yes
Rail mounting possible		Yes
Wall mounting/direct mounting		No
Front build in possible		No

Rack-assembly possible		No
Suitable for safety functions		No
Category according to EN 954-1		
SIL according to IEC 61508		None
Performance level acc. to EN ISO 13849-1		None
Appendant operation agent (Ex ia)		No
Appendant operation agent (Ex ib)		No
Explosion safety category for gas		None
Explosion safety category for dust		None
Width	mm	12.6
Height	mm	74.1
Depth	mm	55.4

## Approvals

Product Standards		UL 508; CSA-C22.2 No. 142; IEC/EN 6113-2; CE marking
UL File No.		E205091
UL Category Control No.		NRAQ, NRAQ7
CSA File No.		UL report applies to both US and Canada
CSA Class No.		2252-01, 2252-81
North America Certification		UL recognized, certified by UL for use in Canada
Specially designed for North America		No
Current Limiting Circuit-Breaker		No
Degree of Protection		IEC: IP20, UL/CSA Type: -

## Dimensions

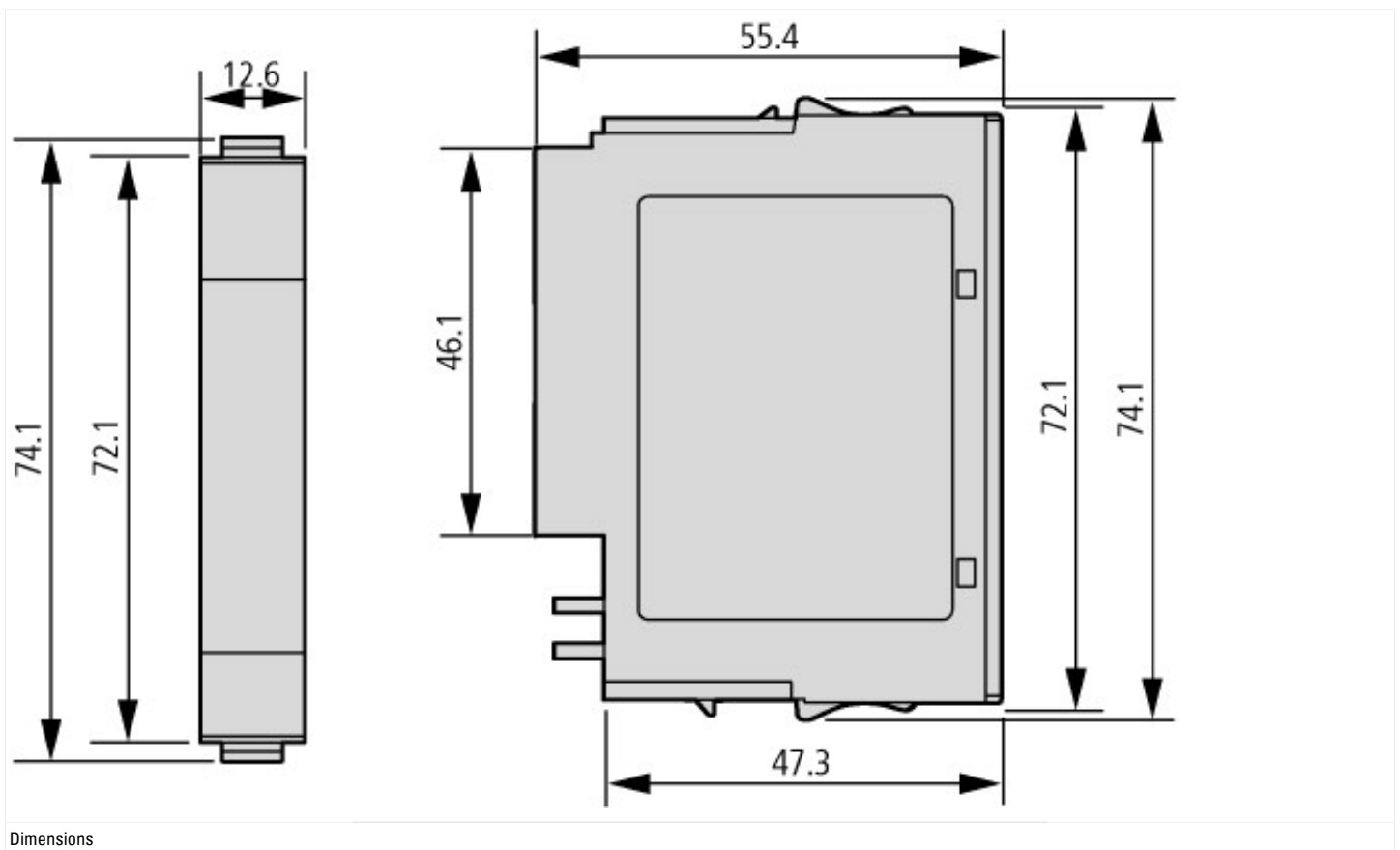

## Additional product information (links)

### MN05002010Z Manual Digital XI/ON modules, power supply modules

MN05002010Z Handbuch Digitale XI/ON-Module Versorgungsmodule - Deutsch [ftp://ftp.moeller.net/DOCUMENTATION/AWB\\_MANUALS/MN05002010Z\\_DE.pdf](ftp://ftp.moeller.net/DOCUMENTATION/AWB_MANUALS/MN05002010Z_DE.pdf)

MN05002010Z Manual Digital XI/ON modules, power supply modules - English [ftp://ftp.moeller.net/DOCUMENTATION/AWB\\_MANUALS/MN05002010Z\\_EN.pdf](ftp://ftp.moeller.net/DOCUMENTATION/AWB_MANUALS/MN05002010Z_EN.pdf)

Technical Data <http://ecat.moeller.net/flip-cat/?edition=HPLEN&startpage=14.111>

