



Analog output module for XC100/200, 24 V DC, 4AO(2x0-10V, 2x4-20mA)

Part no. XIOC-2AO-U1-2AO-I2
Article no. 257902

Delivery program

Function			Analog modules
Description			Compact I/O system for connection to XC100/200 Modular PLCs XC100/200 expandable with up to 15 XI/OC modules Optionally, screw terminals or spring-loaded terminals for digital/analog modules
			Outputs 2 Outputs 0 - 10 V 2 outputs 4 - 20 mA

Technical data

General

Standards			IEC/EN 61131-2 EN 50178
Ambient temperature		°C	0 - +55
Storage	θ	°C	-25 - +70
Vibration resistance			10 - 57 Hz ±0.075 mm 57 - 150 Hz ±1.0 mm
Mechanical shock resistance		g	15 Shock duration 11 ms
Impact resistance			500 g/  50 mm ±25 g
Overvoltage category/pollution degree			II/2
Protection class			1
Degree of Protection			IP20
Emitted interference			DIN/EN 55011/22, Class A
Weight		kg	0.18

Power supply





Rated voltage	U _e	V DC	24 (12)
Admissible range			20.4 – 28.8 (11.8 – 14.4)
Residual ripple		%	 5
Neutral poles			
Duration of dip		ms	10
Repetition rate		s	1
Maximum power loss	P _v	W	0.5

Inputs

External power supply			24 V DC (-15/+20 %), approx. 150 mA
Resolution		Bit	12
Conversion time			 5 ms

Outputs

Output voltage		V DC	0 - 10
Output current		A	0.004 to 0.020
Resolution		Bit	12
Potential isolation			
Circuit within each channel			Opto-isolated
between channels			No
Terminations			Plug-in terminal block
Internal current consumption (5 V DC)		mA	100

Conversion time			 5 ms
Total error		%	 ±1 (of the full-scale value)
External load resistance			
Voltage output			 10 kΩ
Current output		Ω	0 to 500 Ω
Quantity of outputs			
Output voltage			2 (channels 0 and 1)
Output current			2 (channels 2 and 3)
External power supply			24 V DC (-15/+20 %), approx. 150 mA
Connection type			2-core screened cable ( 20 m)

Design verification as per IEC/EN 61439

Technical data for design verification			
Rated operational current for specified heat dissipation	I_n	A	0
Heat dissipation per pole, current-dependent	P_{vid}	W	0
Equipment heat dissipation, current-dependent	P_{vid}	W	0
Static heat dissipation, non-current-dependent	P_{vs}	W	0.5
Heat dissipation capacity	P_{diss}	W	0
Operating ambient temperature min.		°C	0
Operating ambient temperature max.		°C	55
IEC/EN 61439 design verification			
10.2 Strength of materials and parts			
10.2.2 Corrosion resistance			
			Meets the product standard's requirements.
10.2.3.1 Verification of thermal stability of enclosures			
			Meets the product standard's requirements.
10.2.3.2 Verification of resistance of insulating materials to normal heat			
			Meets the product standard's requirements.
10.2.3.3 Verification of resistance of insulating materials to abnormal heat and fire due to internal electric effects			
			Meets the product standard's requirements.
10.2.4 Resistance to ultra-violet (UV) radiation			
			Meets the product standard's requirements.
10.2.5 Lifting			
			Does not apply, since the entire switchgear needs to be evaluated.
10.2.6 Mechanical impact			
			Does not apply, since the entire switchgear needs to be evaluated.
10.2.7 Inscriptions			
			Meets the product standard's requirements.
10.3 Degree of protection of ASSEMBLIES			
			Meets the product standard's requirements.
10.4 Clearances and creepage distances			
			Meets the product standard's requirements.
10.5 Protection against electric shock			
			Does not apply, since the entire switchgear needs to be evaluated.
10.6 Incorporation of switching devices and components			
			Does not apply, since the entire switchgear needs to be evaluated.
10.7 Internal electrical circuits and connections			
			Is the panel builder's responsibility.
10.8 Connections for external conductors			
			Is the panel builder's responsibility.
10.9 Insulation properties			
10.9.2 Power-frequency electric strength			
			Is the panel builder's responsibility.
10.9.3 Impulse withstand voltage			
			Is the panel builder's responsibility.
10.9.4 Testing of enclosures made of insulating material			
			Is the panel builder's responsibility.
10.10 Temperature rise			
			The panel builder is responsible for the temperature rise calculation. Eaton will provide heat dissipation data for the devices.
10.11 Short-circuit rating			
			Is the panel builder's responsibility.
10.12 Electromagnetic compatibility			
			Is the panel builder's responsibility.
10.13 Mechanical function			
			The device meets the requirements, provided the information in the instruction leaflet (IL) is observed.

Technical data ETIM 6.0

PLC's (EG000024) / PLC analogue I/O-module (EC001420)			
Electric engineering, automation, process control engineering / Control / Programmable logic control (SPS) / SPS analog input/output module (ec1@ss8.1-27-24-22-01 [AKE524011])			
Number of analogue inputs			0
Number of analogue outputs			4
Analog inputs configurable			Yes

Analog outputs configurable			Yes
Input, current			No
Input, voltage			No
Input, resistor			No
Input, resistance thermometer			No
Input, thermocouple			No
Input signal, configurable			No
Resolution of the analogue inputs		Bit	0
Output, current			Yes
Output, voltage			Yes
Output signal configurable			No
Resolution of the analogue outputs		Bit	12
Type of electric connection			Screw-/spring clamp connection
Suitable for safety functions			No
Category according to EN 954-1			
SIL according to IEC 61508			None
Performance level acc. to EN ISO 13849-1			None
Appendant operation agent (Ex ia)			No
Appendant operation agent (Ex ib)			No
Explosion safety category for gas			None
Explosion safety category for dust			None
Width		mm	30
Height		mm	100
Depth		mm	95

Approvals

Product Standards			IEC: see Technical Data; UL508; CSA-C22.2 No. 0-M; CSA-C22.2 No. 142-M; CE marking
UL File No.			E135462
UL Category Control No.			NRAQ
CSA File No.			012528
CSA Class No.			2252-01
North America Certification			UL listed, CSA certified
Specially designed for North America			No
Current Limiting Circuit-Breaker			No
Degree of Protection			IEC: IP20, UL/CSA Type: -

Dimensions

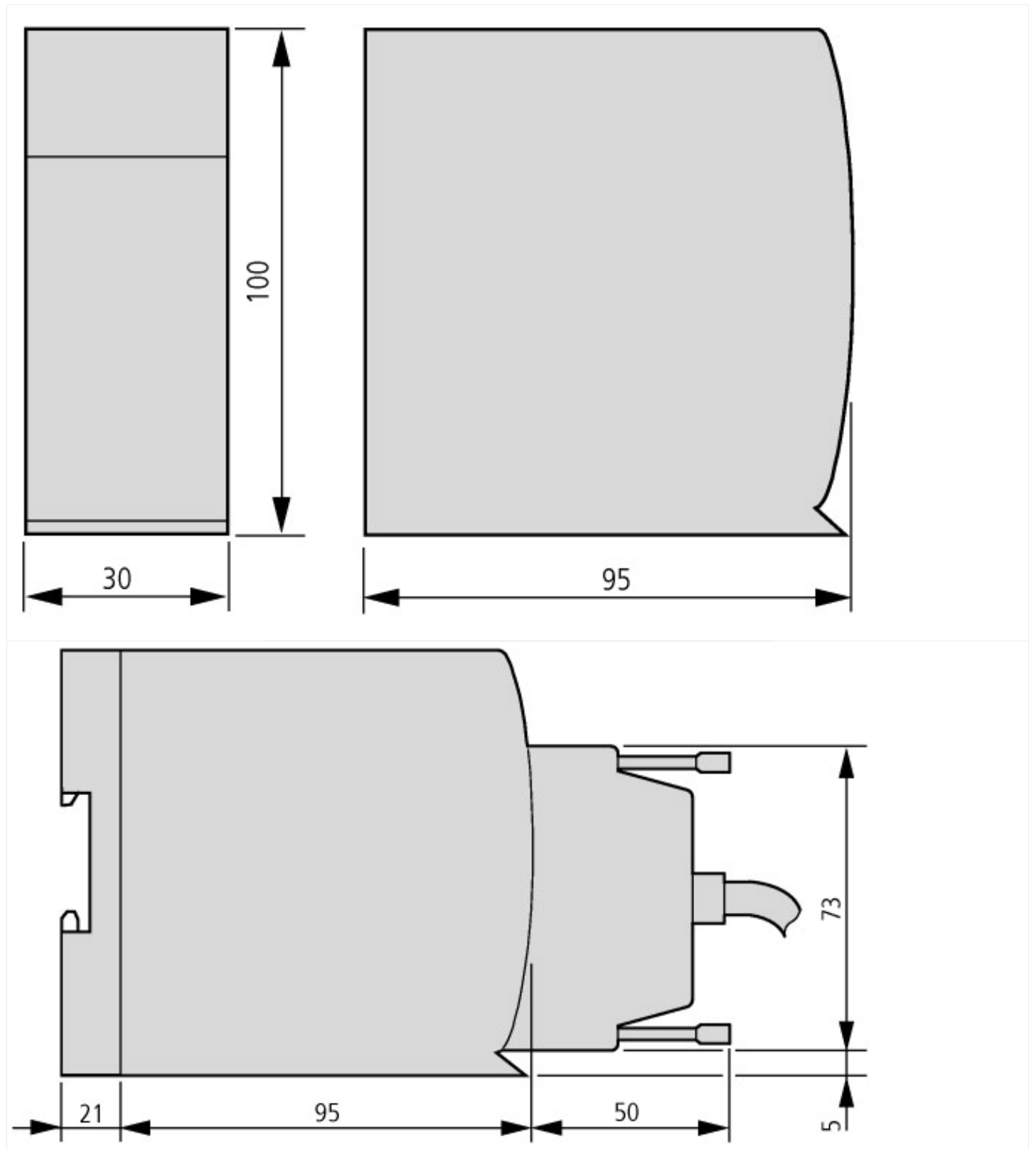

Additional product information (links)

MN05002002Z (AWB2725-1452) XIOC signal modules

MN05002002Z (AWB2725-1452) XIOC-Signalmodule - Deutsch

ftp://ftp.moeller.net/DOCUMENTATION/AWB_MANUALS/MN05002002Z_DE.pdf

MN05002002Z (AWB2725-1452) XIOC signal modules - English

ftp://ftp.moeller.net/DOCUMENTATION/AWB_MANUALS/MN05002002Z_EN.pdf