



Switch-disconnector, 3 pole, 2000A, without protection, IEC, Withdrawable

Part no. INX40B3-20W-1
Catalog No. 184060

EL-Nummer 4398422
(Norway)

Delivery program

Product range			Air circuit-breakers/switch-disconnectors
Product range			Open switch-disconnectors
Current Range			Up to 4000 A
Protective function			without protection
Installation type			Withdrawable
			Cassette must be separately ordered.
Construction size			INX40
Release system			without releases
Standard/Approval			IEC
Number of poles			3 pole
Degree of Protection			IP31 with door seals, IP55 with protective cover
			optionally fittable by user with comprehensive accessories
Rated current = rated uninterrupted current	$I_n = I_u$	A	2000
Rated short-circuit making capacity up to 440V/690V 42/42	I_{cm}	kA	145
Rated short-time withstand current t=1 s	I_{cw}	kA	66
Rated short-time withstand current t=3 s	I_{cw}	kA	53

Technical data

General

Standards			IEC/EN 60947
Ambient temperature			
Storage	θ	°C	-40 - +70
Ambient temperature		°C	-25 - +70
Mounting position			
Utilization category			B
Degree of Protection			IP31 with door seals, IP55 with protective cover
Direction of incoming supply			as required

Main conducting paths

Rated current = rated uninterrupted current	$I_n = I_u$	A	2000
Rated uninterrupted current at 50 °C	I_u	A	2000
Rated uninterrupted current at 60 °C	I_u	A	2000
Rated uninterrupted current at 70 °C	I_u	A	2000
Rated impulse withstand voltage	U_{imp}	V AC	12000
Rated operational voltage	U_e	V AC	690
Overvoltage category/pollution degree			III/3
Rated insulation voltage	U_i	V	1000

Switching capacity

Rated short-circuit making capacity	I_{cm}		
up to 440 V 50/60 Hz	I_{cm}	kA	145
up to 690 V 50/60 Hz	I_{cm}	kA	145

Operating times			
Closing delay via spring release		ms	30
Total opening delay via shunt release		ms	35
Total opening delay via undervoltage release		ms	40
Lifespan			
Lifespan, mechanical	Switching cycles (ON/OFF)		10000
Lifespan, mechanical with maintenance	Switching cycles (ON/OFF)		20000.
Lifespan, electrical	Switching cycles (ON/OFF)		8000
Lifespan, electrical with maintenance	Switching cycles (ON/OFF)		16000.
Maximum operating frequency			
Maximum operating frequency	Operations/h		60
Heat dissipation at rated current I_n			
Withdrawable units (switch with cassette)		W	395

Weight

Withdrawable			
3-pole		kg	60
Cassette			
3 pole		kg	29

Terminal capacities

Copper bar			
Withdrawable units			
Black		mm	2 x 80 x 10
<p>These are values used in separate switchgear. The actual values will depend on the temperature around the circuit-breaker, which is influenced by the ambient temperature, the degree of protection (IP), the mounting height, the partitions, and any external ventilation. Depending on the specific switchgear design, this may result in derating, which can then be compensated for by increasing the cross-sectional area. Temperature rise tests in the specific switchgear can provide specific and detailed information.</p>			

Design verification as per IEC/EN 61439

Technical data for design verification			
Rated operational current for specified heat dissipation	I_n	A	2000
Equipment heat dissipation, current-dependent	P_{vid}	W	395
Operating ambient temperature min.		°C	-25
Operating ambient temperature max.		°C	70
IEC/EN 61439 design verification			
10.2 Strength of materials and parts			
10.2.2 Corrosion resistance			Meets the product standard's requirements.
10.2.3.1 Verification of thermal stability of enclosures			Meets the product standard's requirements.
10.2.3.2 Verification of resistance of insulating materials to normal heat			Meets the product standard's requirements.
10.2.3.3 Verification of resistance of insulating materials to abnormal heat and fire due to internal electric effects			Meets the product standard's requirements.
10.2.4 Resistance to ultra-violet (UV) radiation			Meets the product standard's requirements.
10.2.5 Lifting			Does not apply, since the entire switchgear needs to be evaluated.
10.2.6 Mechanical impact			Does not apply, since the entire switchgear needs to be evaluated.
10.2.7 Inscriptions			Meets the product standard's requirements.
10.3 Degree of protection of ASSEMBLIES			Does not apply, since the entire switchgear needs to be evaluated.
10.4 Clearances and creepage distances			Meets the product standard's requirements.
10.5 Protection against electric shock			Does not apply, since the entire switchgear needs to be evaluated.
10.6 Incorporation of switching devices and components			Does not apply, since the entire switchgear needs to be evaluated.
10.7 Internal electrical circuits and connections			Is the panel builder's responsibility.
10.8 Connections for external conductors			Is the panel builder's responsibility.

10.9 Insulation properties			
10.9.2 Power-frequency electric strength			Is the panel builder's responsibility.
10.9.3 Impulse withstand voltage			Is the panel builder's responsibility.
10.9.4 Testing of enclosures made of insulating material			Is the panel builder's responsibility.
10.10 Temperature rise			The panel builder is responsible for the temperature rise calculation. Eaton will provide heat dissipation data for the devices.
10.11 Short-circuit rating			Is the panel builder's responsibility. The specifications for the switchgear must be observed.
10.12 Electromagnetic compatibility			Is the panel builder's responsibility. The specifications for the switchgear must be observed.
10.13 Mechanical function			The device meets the requirements, provided the information in the instruction leaflet (IL) is observed.

Technical data ETIM 7.0

Low-voltage industrial components (EG000017) / Switch disconnecter (EC000216)			
Electric engineering, automation, process control engineering / Low-voltage switch technology / Off-load switch, circuit breaker, control switch / Switch disconnecter (ec@ss10.0.1-27-37-14-03 [AKF060013])			
Version as main switch			Yes
Version as maintenance-/service switch			No
Version as safety switch			No
Version as emergency stop installation			No
Version as reversing switch			No
Number of switches			
Max. rated operation voltage U _e AC		V	690
Rated operating voltage		V	690 - 690
Rated permanent current I _u		A	2000
Rated permanent current at AC-23, 400 V		A	
Rated permanent current at AC-21, 400 V		A	0
Rated operation power at AC-3, 400 V		kW	0
Rated short-time withstand current I _{cw}		kA	66
Rated operation power at AC-23, 400 V		kW	0
Switching power at 400 V		kW	0
Conditioned rated short-circuit current I _q		kA	144
Number of poles			3
Number of auxiliary contacts as normally closed contact			0
Number of auxiliary contacts as normally open contact			0
Number of auxiliary contacts as change-over contact			2
Motor drive optional			Yes
Motor drive integrated			No
Voltage release optional			Yes
Device construction			Built-in device slide-in technique (withdrawable)
Suitable for ground mounting			Yes
Suitable for front mounting 4-hole			No
Suitable for front mounting centre			No
Suitable for distribution board installation			Yes
Suitable for intermediate mounting			No
Colour control element			Green
Type of control element			Push button
Interlockable			Yes
Type of electrical connection of main circuit			Rail connection
Degree of protection (IP), front side			IP31
Degree of protection (NEMA)			

Dimensions

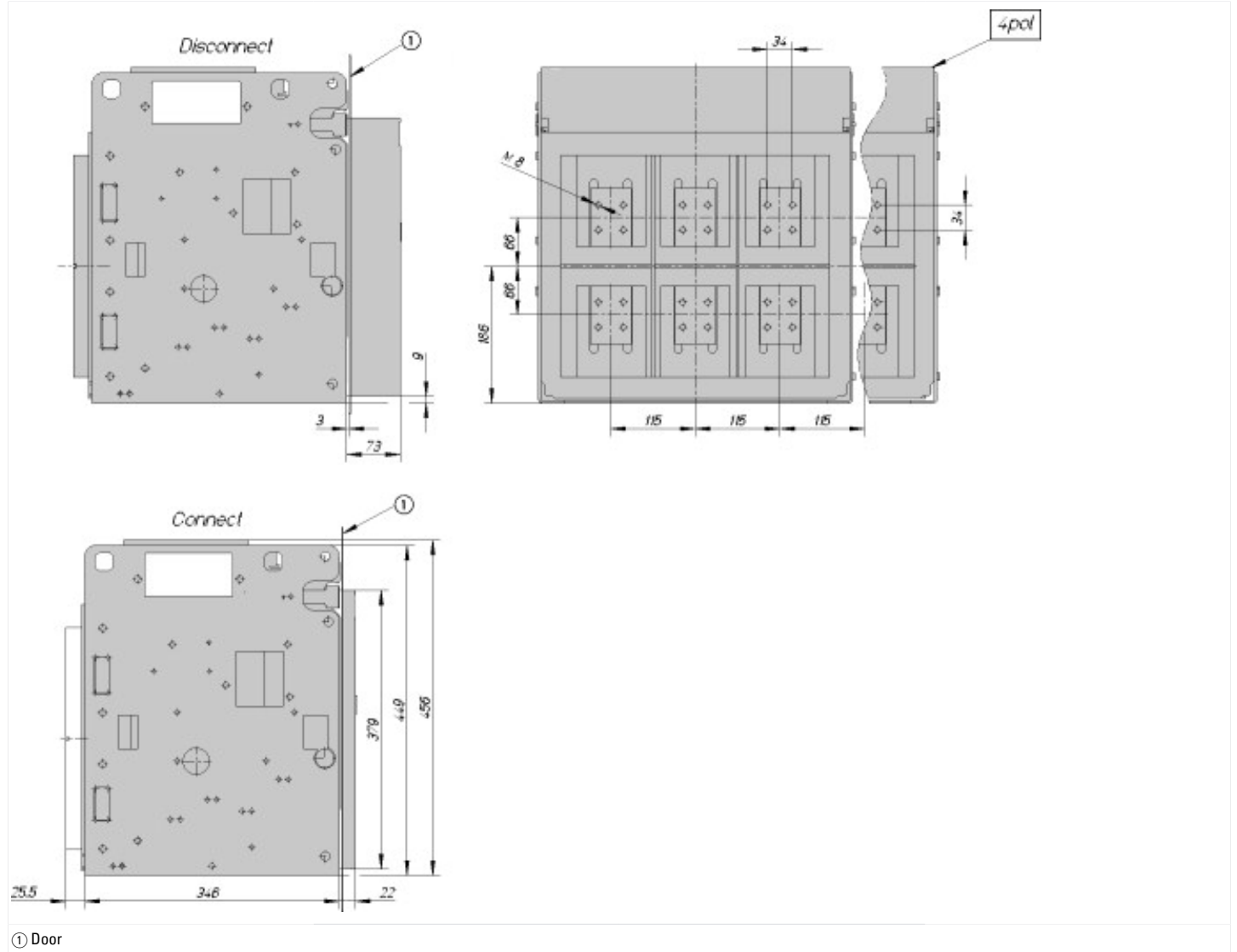

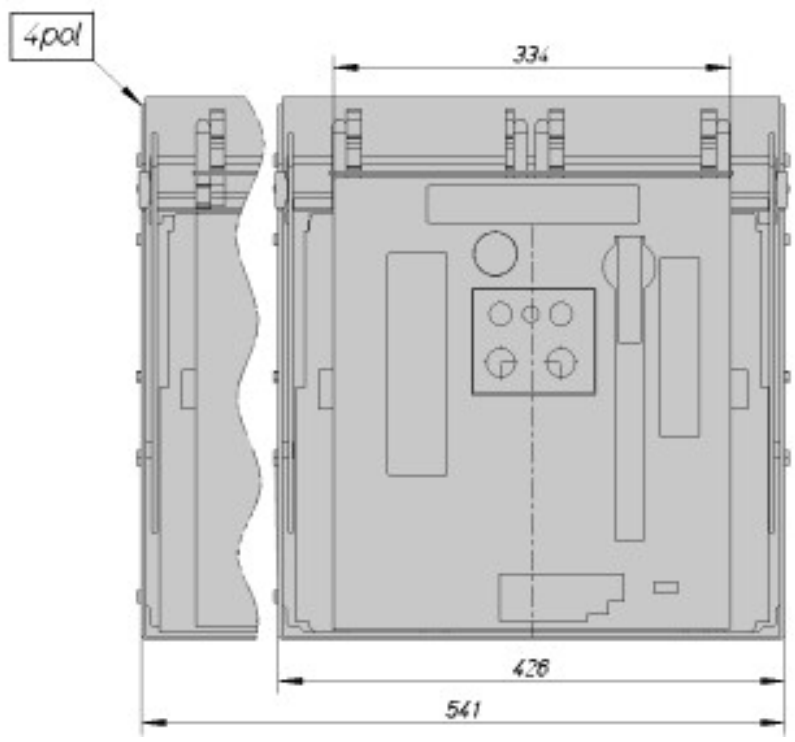
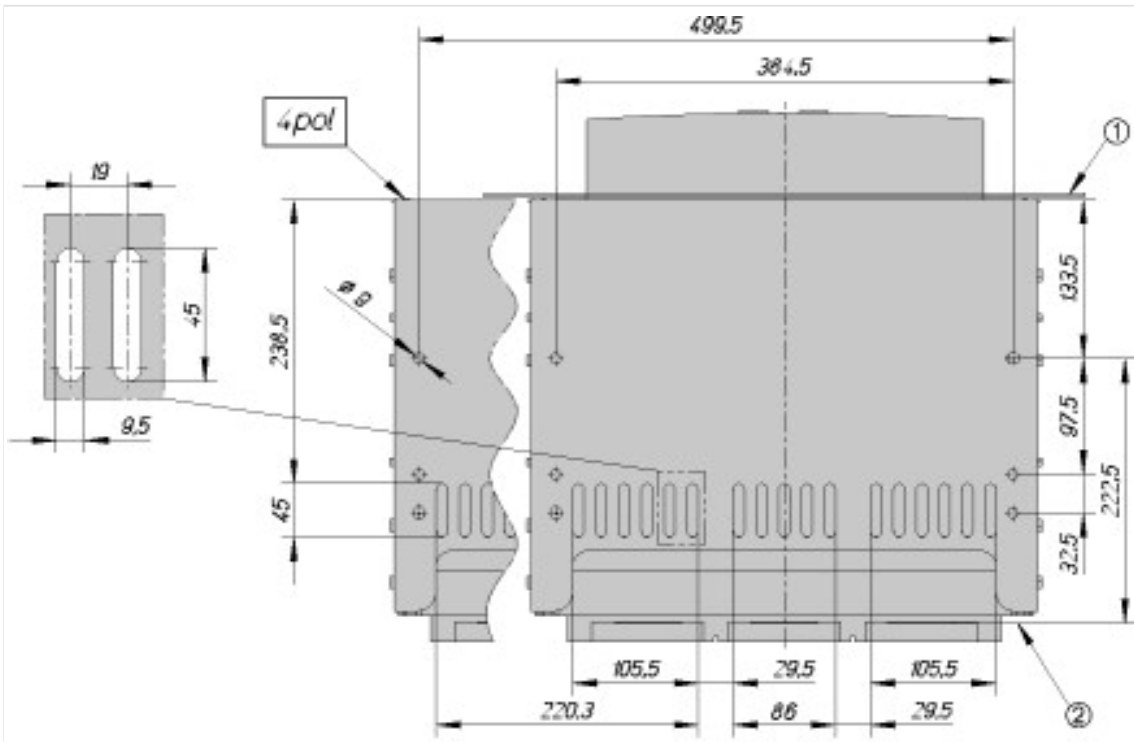

- ① Door
- ② Contact surface flange terminal