

Isolerstoffkapslinger type: EK EKU

Lokk: 30 mm høye grå
EKU 30-G - 2536284

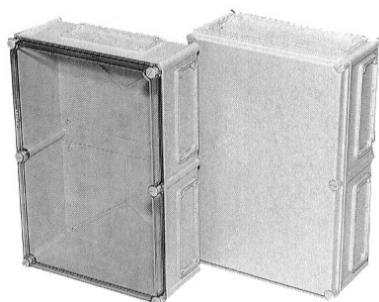



Tekniskinformasjon:

Slagfast polykarbonat med klare og grå lokk.

IP 67, halogenfri, polykarbonat,
-40°C - +120°C
max. 80°C kontinuerlig

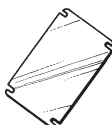
Tilleggsutstyr:

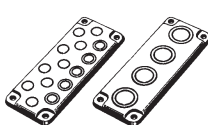
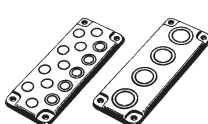
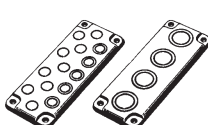
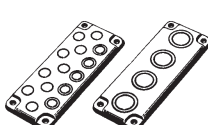
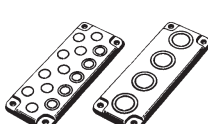
Type	EL.nr.
 EKUVT	2536447
 EKUZR	2536375
 MB 10546	2536381
 MB 10324	2536389
 MB 10593	2536385
 MB 10594	2536386
 MB 10595	2536387
 MB 10596	2536388

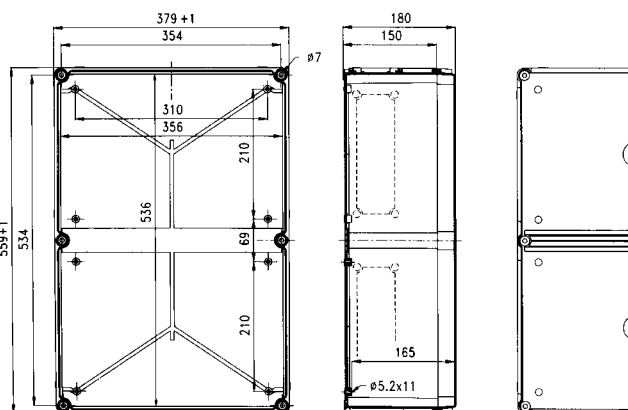

Egenskaper	Klassifisering
- Tetthetsgrad	IP-67 (IEC 529)
- Totalisolert	<input type="checkbox"/>
- Standard farge	Lys grå (RAL 7035)
- Kapslingsmateriale	
Underdel	Glassfiberarmert polykarbonat
Lokk	Polykarbonat
Lokkskruer	Polyamid
Pakning	Polyuretan/EPDM
Polykarbonatets egenskaper:	
- Temperaturbestandighet:	
- Max temperatur, kortvarig	-40°C til +120°C
- Max temperatur, kontinuerlig	Max +80°C
- Slagfasthet	Meget høy (ved +23°C DIN 53453 ISO/R179 50 kJ/m ² for underdel)
- Brennbarhet	Selvslukkende
- Brannklasse	UL 94-5V
- Avgasser	Halogenfri
- Kjemiske egenskaper	Meget god (be om egen oversikt)