

# Isolerstoffkapslinger type: EK EKU

Lokk: 30 mm høye klare  
EKU 30-T - 2536282

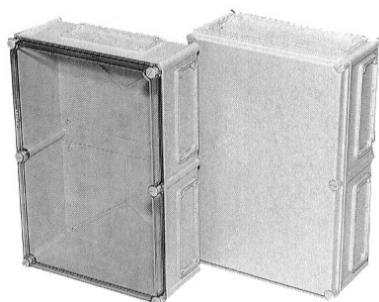

## Tekniskinformasjon:



Slagfast polykarbonat med klare og grå lokk.

IP 67, halogenfri, polykarbonat,  
-40°C - +120°C  
max. 80°C kontinuerlig

## Tilleggsutstyr:

### Type

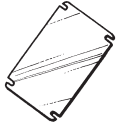
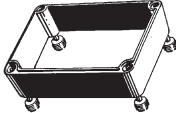
### EL.nr.

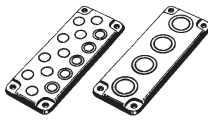
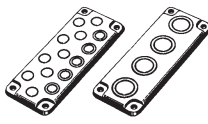
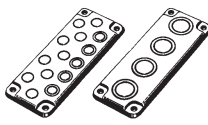
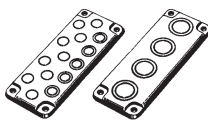
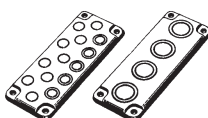
	EKUVT	2536447
	EKUZR	2536375
	MB 10546	2536381
	MB 10324	2536389
	MB 10593	2536385
	MB 10594	2536386
	MB 10595	2536387
	MB 10596	2536388

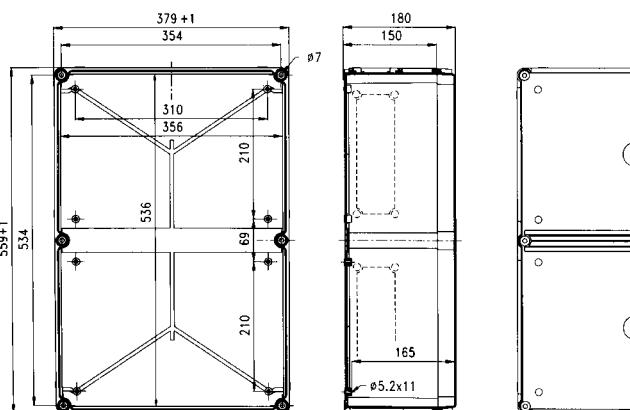

Egenskaper	Klassifisering
- Tetthetsgrad	IP-67 (IEC 529)
- Totalisolert	<input type="checkbox"/>
- Standard farge	Lys grå (RAL 7035)
- Kapslingsmateriale	
Underdel	Glassfiberarmert polykarbonat
Lokk	Polykarbonat
Lokkskruer	Polyamid
Pakning	Polyuretan/EPDM
Polykarbonatets egenskaper:	
- Temperaturbestandighet:	
- Max temperatur, kortvarig	-40°C til +120°C
- Max temperatur, kontinuerlig	Max +80°C
- Slagfasthet	Meget høy (ved +23°C DIN 53453 ISO/R179 50 kJ/m <sup>2</sup> for underdel)
- Brennbarhet	Selvslukkende
- Brannklasse	UL 94-5V
- Avgasser	Halogenfri
- Kjemiske egenskaper	Meget god (be om egen oversikt)