

# Isolerstoffkapslinger type: EK EKM

Lokk: 30 mm høye klart  
EKM 30-T - 2536250

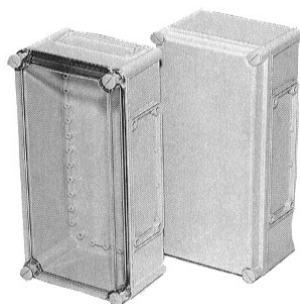

## Tekniskinformasjon:

Slagfast polykarbonat med klare og grå lokk.

IP 67, halogenfri, polykarbonat,  
-40°C - +120°C  
max. 80°C kontinuerlig

## Tilleggsutstyr:

### Type

### EL.nr.

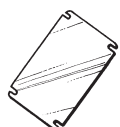

EKMVT

2536443

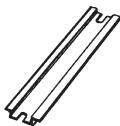

EKV 12

2536454

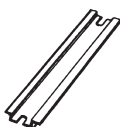

EKV 22

2536455



EKMZR

2536371



MB 10215

2536380



MB 10546

2536381

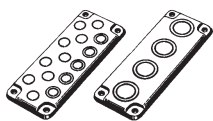

MB 10593

2536385

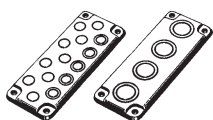

MB 10594

2536386

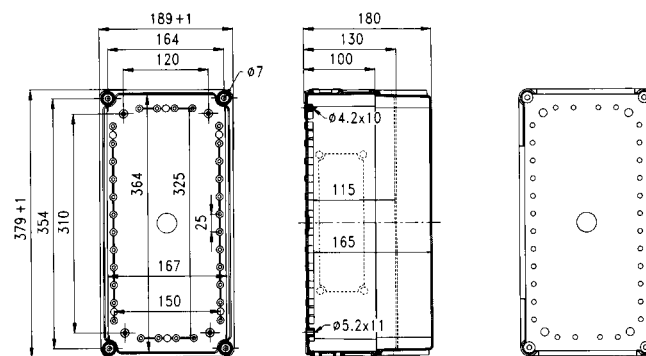

Egenskaper	Klassifisering
<ul style="list-style-type: none"> <li>- Tetthetsgrad</li> <li>- Totalisolert</li> <li>- Standard farge</li> <li>- Kapslingsmateriale</li> </ul>	IP-67 (IEC 529) <input type="checkbox"/> Lys grå (RAL 7035)
Underdel Lokk Lokkskruer Pakning	Glassfiberarmert polykarbonat Polykarbonat Polyamid Polyuretan/EPDM
Polykarbonatets egenskaper: <ul style="list-style-type: none"> <li>- Temperaturbestandighet:</li> <li>- Max temperatur, kortvarig</li> <li>- Max temperatur, kontinuerlig</li> <li>- Slagfasthet</li> </ul>	-40°C til +120°C Max +80°C Meget høy (ved +23°C DIN 53453 ISO/R179 50 kJ/m <sup>2</sup> for underdel)
<ul style="list-style-type: none"> <li>- Brennbarhet</li> <li>- Brannklasse</li> <li>- Avgasser</li> <li>- Kjemiske egenskaper</li> </ul>	Selvslukkende UL 94-5V Halogenfri Meget god (be om egen oversikt)