

Isolerstoffkapslinger type: MNX PCM PCM 200 X

255 x 180 x 100 mm (86,8 mm indre) grått lokk

PCM 200/100 XG - 2535541



Teknisk informasjon:

Slagfast polykarbonat.
Med klare og grå lokk.
Metriske nippelutslag.

IP 67, halogenfri, polykarbonat,
-40°C – +120°C
max. 80°C kontinuerlig

PCM.../...T = klart lokk
PCM.../...G = grått lokk
(begge m/50 mm underdel)
PCM.../...XT = klart lokk
PCM.../...XG = grått lokk
(begge m/75 mm underdel)

Tilleggsutstyr:

Type EL.nr.

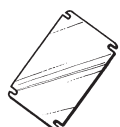

MIV 200 2536114

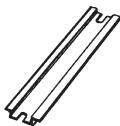

MIV 15 2536122

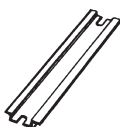

MIV 20 2536123

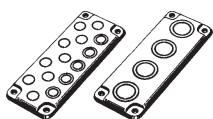

FP A200/180 2535550

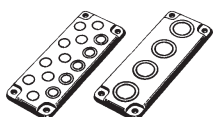

HFP 180 2535552

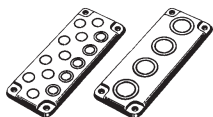

TH A 2535553

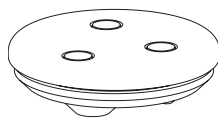

FP 22046 2535554



SS 14550L 2535555

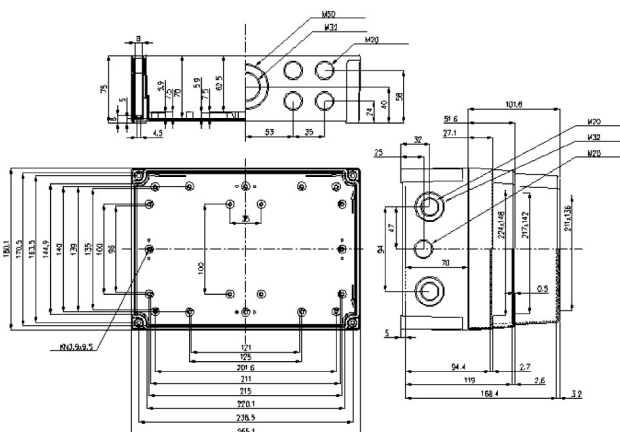

Egenskaper	Klassifisering
<ul style="list-style-type: none"> - Tetthetsgrad - Totalisolert - Standard farge - Kapslingsmateriale Underdel Lokk Lokkskruer Pakning 	<p>IP-67 (IEC-529)</p> <p><input type="checkbox"/></p> <p>Lys grå (RAL-7035)</p> <p>Glassfiberarmert polykarbonat</p> <p>Polykarbonat</p> <p>Polyamid</p> <p>Polyuretan/EPDM</p>
<p>Polykarbonatets egenskaper:</p> <ul style="list-style-type: none"> - Temperaturbestandighet: <ul style="list-style-type: none"> - Max temperatur, kortvarig - Max temperatur, kontinuerlig - Slagfasthet - Brennbarhet - Brannklasse - Avgasser - Kjemiske egenskaper 	<p>-40°C til +120°C</p> <p>-40°C til +80°C</p> <p>Meget høy (ved +23°C DIN 53453 ISO/R179 50 kJ/m² for underdel)</p> <p>Selvslukkende</p> <p>UL94-5V (UL 746 C 5)</p> <p>Halogenfri</p> <p>Meget god (be om egen oversikt)</p>