

Isolerstoffkapslinger type: MNX PCM PCM 175

180 x 180 x 100 mm (86,3 mm indre) grått lokk

PCM 175/100 G - 2535529



Teknisk informasjon:

Slagfast polykarbonat.
Med klare og grå lokk.
Metriske nippelutslag.

IP 67, halogenfri, polykarbonat,
-40°C – +120°C
max. 80°C kontinuerlig

PCM.../...T = klart lokk
PCM.../...G = grått lokk
(begge m/50 mm høy underdel)

Tilleggsutstyr:

Type EL.nr.

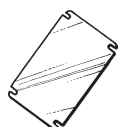

MIV 175 2536113

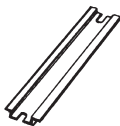

MIV 15 2536122

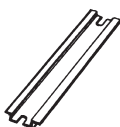

FP A175/180 2535549

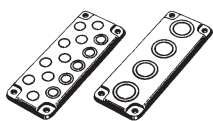

HFP 180 2535552

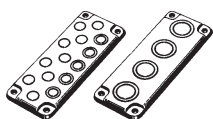

TH A 2535553

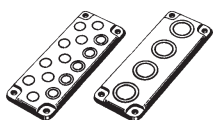

FP 22046 2535554

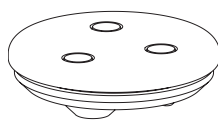

SS 14550L 2535555



SS 14551H 2535556

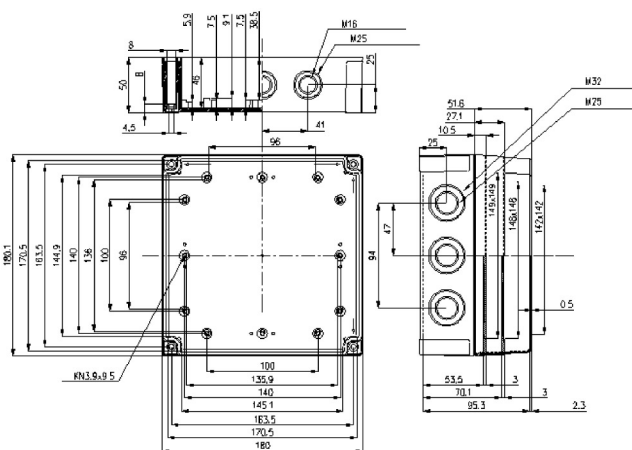

Egenskaper

- Tetthetsgrad
- Totalisolert
- Standard farge
- Kapslingsmateriale
Underdel
Lokk
Lokkskruer
Pakning
- Polykarbonatets egenskaper:**
 - Temperaturbestandighet:
 - Max temperatur, kortvarig -40°C til +120°C
 - Max temperatur, kontinuerlig -40°C til +80°C
 - Slagfasthet
 - Brennbarhet
 - Brannklasse
 - Avgasser
 - Kjemiske egenskaper

Klassifisering

- IP-67 (IEC-529)
- Lys grå (RAL-7035)
- Glassfiberarmert polykarbonat
- Polykarbonat
- Polyamid
- Polyuretan/EPDM
- Meget høy (ved +23°C
DIN 53453 ISO/R179 50 kJ/m²
for underdel)
- Selvslukkende
- UL94-5V (UL 746 C 5)
- Halogenfri
- Meget god (be om egen oversikt)