

# Isolerstoffkapslinger type: MNX PCM PCM 175

180 x 180 x 100 mm (86,3 mm indre) klart lokk

PCM 175/100 T - 2535528





## Teknisk informasjon:

Slagfast polykarbonat.  
Med klare og grå lokk.  
Metriske nippelutslag.

IP 67, halogenfri, polykarbonat,  
-40°C – +120°C  
max. 80°C kontinuerlig

PCM.../...T = klart lokk  
PCM.../...G = grått lokk  
(begge m/50 mm høy underdel)

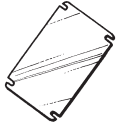
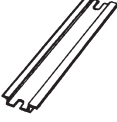
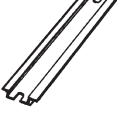
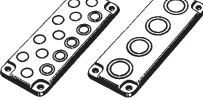
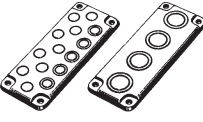
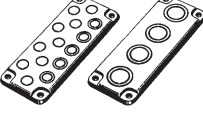
## Tilleggsutstyr:

Type	EL.nr.
 MIV 175	2536113
 MIV 15	2536122
 FP A175/180	2535549
 HFP 180	2535552
 TH A	2535553
 FP 22046	2535554
 SS 14550L	2535555
 SS 14551H	2535556

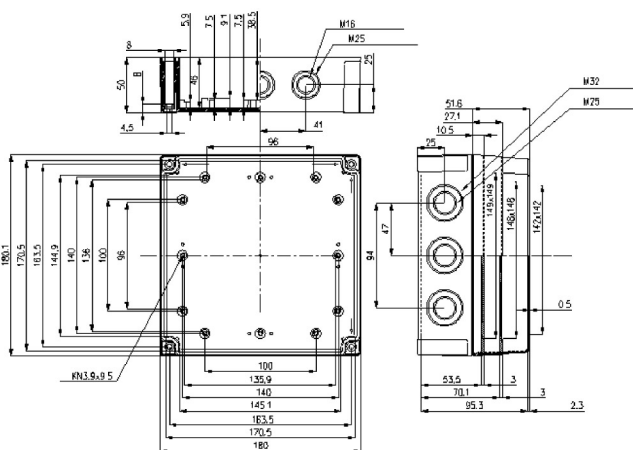

Egenskaper	Klassifisering
<ul style="list-style-type: none"> <li>- Tetthetsgrad</li> <li>- Totalisolert</li> <li>- Standard farge</li> <li>- Kapslingsmateriale</li> <li>  Underdel</li> <li>  Lokk</li> <li>  Lokkskruer</li> <li>  Pakning</li> </ul>	<p>IP-67 (IEC-529)</p> <p><input type="checkbox"/></p> <p>Lys grå (RAL-7035)</p> <p>Glassfiberarmert polykarbonat Polykarbonat Polyamid Polyuretan/EPDM</p>
<p><b>Polykarbonatets egenskaper:</b></p> <ul style="list-style-type: none"> <li>- Temperaturbestandighet:               <ul style="list-style-type: none"> <li>- Max temperatur, kortvarig</li> <li>- Max temperatur, kontinuerlig</li> </ul> </li> <li>- Slagfasthet</li> <li>- Brennbarhet</li> <li>- Brannklasse</li> <li>- Avgasser</li> <li>- Kjemiske egenskaper</li> </ul>	<p>-40°C til +120°C -40°C til +80°C</p> <p>Meget høy (ved +23°C DIN 53453 ISO/R179 50 kJ/m² for underdel)</p> <p>Selvslukkende UL94-5V (UL 746 C 5)</p> <p>Halogenfri Meget god (be om egen oversikt)</p>