

Isolerstoffkapslinger type: MNX PCM PCM 175

180 x 180 x 60 mm (44 mm indre) grått lokk
PCM 175/60 G - 2535525



Tekniskinformasjon:

Slagfast polykarbonat.
Med klare og grå lokk.
Metriske nippelutslag.

IP 67, halogenfri, polykarbonat,
-40°C – +120°C
max. 80°C kontinuerlig

PCM.../...T = klart lokk
PCM.../...G = grått lokk
(begge m/50 mm høy underdel)

Tilleggsutstyr:

Type EL.nr.

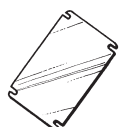

MIV 175

2536113

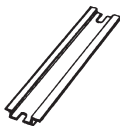

MIV 15

2536122

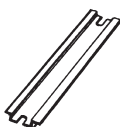

FP A175/180

2535549

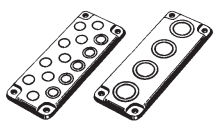

HFP 180

2535552

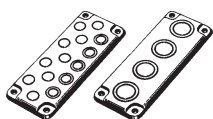

TH A

2535553

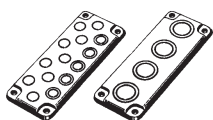

FP 22046

2535554

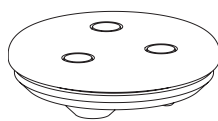

SS 14550L

2535555



SS 14551H

2535556

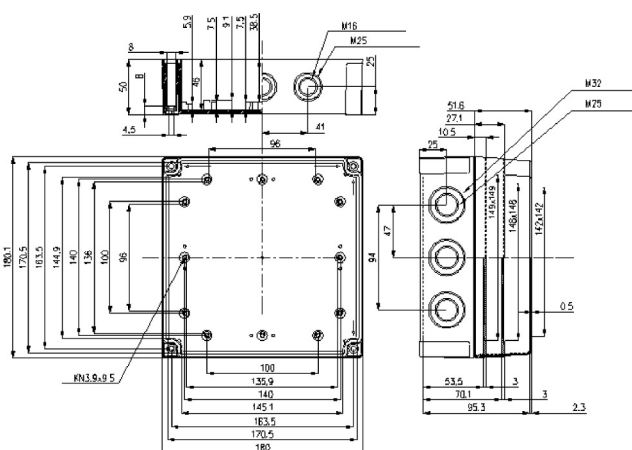

Egenskaper	Klassifisering
<ul style="list-style-type: none"> - Tetthetsgrad - Totalisolert - Standard farge - Kapslingsmateriale Underdel Lokk Lokkskruer Pakning 	<p>IP-67 (IEC-529)</p> <p><input type="checkbox"/></p> <p>Lys grå (RAL-7035)</p> <p>Glassfiberarmert polykarbonat Polykarbonat Polyamid Polyuretan/EPDM</p>
<p>Polykarbonatets egenskaper:</p> <ul style="list-style-type: none"> - Temperaturbestandighet: <ul style="list-style-type: none"> - Max temperatur, kortvarig - Max temperatur, kontinuerlig - Slagfasthet - Brennbarhet - Brannklasse - Avgasser - Kjemiske egenskaper 	<p>-40°C til +120°C -40°C til +80°C</p> <p>Meget høy (ved +23°C DIN 53453 ISO/R179 50 kJ/m² for underdel)</p> <p>Selvslukkende</p> <p>UL94-5V (UL 746 C 5)</p> <p>Halogenfri</p> <p>Meget god (be om egen oversikt)</p>