

Isolerstoffkapslinger type: MNX PCM PCM 150

180 x 130 x 125 mm (111,3 mm indre) grått lokk

PCM 150/125 G - 2535523



Teknisk informasjon:

Slagfast polykarbonat.
Med klare og grå lokk.
Metriske nippelutslag.

IP 67, halogenfri, polykarbonat,
-40°C – +120°C
max. 80°C kontinuerlig

PCM.../...T = klart lokk
PCM.../...G = grått lokk
(begge m/50 mm høy underdel)

Tilleggsutstyr:

Type

EL.nr.

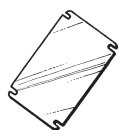

MIV 150

2536112

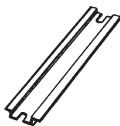

MIV 10

2536121

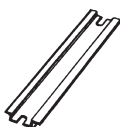

MIV 15

2536122

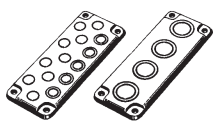

FPA 150/180

2535548

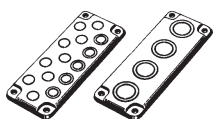

HFP 180

2535552

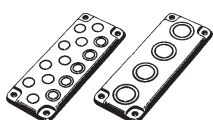

TH A

2535553

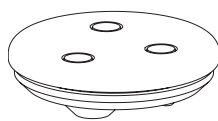

FP 22046

2535554



SS 14550L

2535555

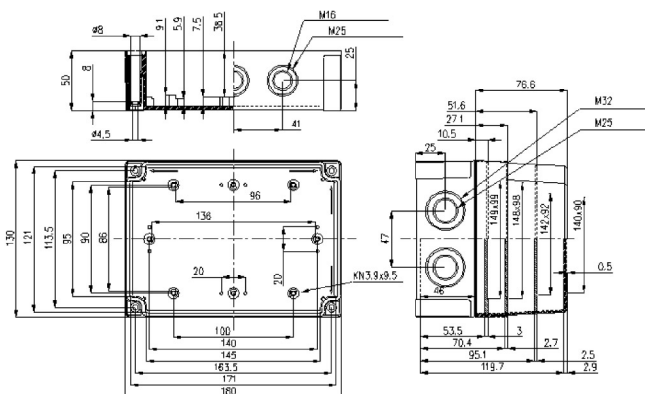

Egenskaper

- Tetthetsgrad
- Totalisolert
- Standard farge
- Kapslingsmateriale
Underdel
Lokk
Lokkskruer
Pakning
- Polykarbonatets egenskaper:**
 - Temperaturbestandighet:
 - Max temperatur, kortvarig
 - Max temperatur, kontinuerlig
 - Slagfasthet
 - Brennbarhet
 - Brannklasse
 - Avgasser
 - Kjemiske egenskaper

Klassifisering

- IP-67 (IEC-529)
-
- Lys grå (RAL-7035)
- Glassfiberarmert polykarbonat
- Polykarbonat
- Polyamid
- Polyuretan/EPDM
- Meget høy (ved +23°C
DIN 53453 ISO/R179 50 kJ/m²
for underdel)
- Selvslukkende
- UL94-5V (UL 746 C 5)
- Halogenfri
- Meget god (be om egen oversikt)