

Isolerstoffkapslinger type: MNX PCM PCM 100

130 x 80 x 75 mm (61 mm indre) klart lokk
PCM 100/75 T - 2535502

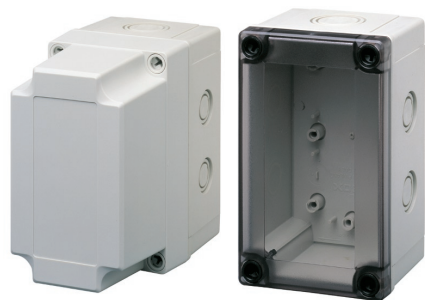

Teknisk informasjon:

Slagfast polykarbonat.
Med klare og grå lokk.
Metriske nippelutslag.

IP 67, halogenfri, polykarbonat,
-40°C – +120°C
max. 80°C kontinuerlig

PCM.../...T = klart lokk
PCM.../...G = grått lokk
(begge m/50 mm underdel)

Tilleggsutstyr:

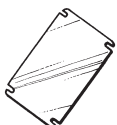
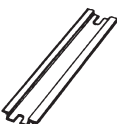
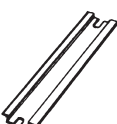
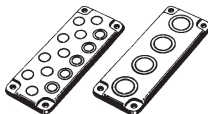
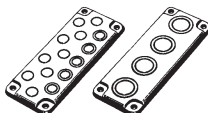
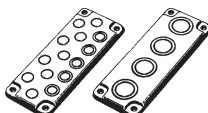
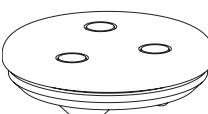
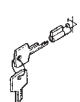
	Type	EL.nr.
	MIV 100	2536110
	MIV 5	2536120
	MIV 10	2536121
	FPA 100/130	2535546
	HFP 130	2535551
	TH A	2535553
	FP 22046	2535554
	SS 14550L	2535555

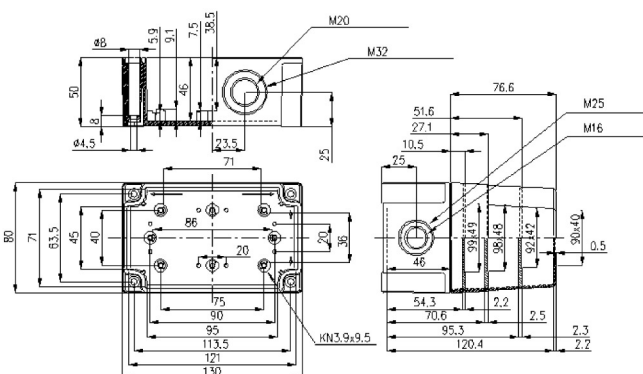

Egenskaper	Klassifisering
<ul style="list-style-type: none"> - Tetthetsgrad - Totalisolert - Standard farge - Kapslingsmateriale Underdel Lokk Lokkskruer Pakning 	<p>IP-67 (IEC-529)</p> <p><input type="checkbox"/> Lys grå (RAL-7035)</p> <p>Glassfiberarmert polykarbonat Polykarbonat Polyamid Polyuretan/EPDM</p>
<p>Polykarbonatets egenskaper:</p> <ul style="list-style-type: none"> - Temperaturbestandighet: <ul style="list-style-type: none"> - Max temperatur, kortvarig - Max temperatur, kontinuerlig - Slagfasthet - Brennbarhet - Brannklasse - Avgasser - Kjemiske egenskaper 	<p>-40°C til +120°C -40°C til +80°C</p> <p>Meget høy (ved +23°C DIN 53453 ISO/R179 50 kJ/m² for underdel)</p> <p>Selvslukkende UL94-5V (UL 746 C 5)</p> <p>Halogenfri Meget god (be om egen oversikt)</p>