



## IKA standard distribution board, IP65 without clamps

**Part no.** IKA-1/8-OT  
**Article no.** 174205  
**Catalog No.** IKA-1/8-OT

### Delivery program

Basic function			Basic device
Product function			Installation distribution boards
Product range			IKA standard DBO
Design			Surface mounted
Installation site			Indoor
Type of installation			Surface mounting
Door/Flap			Transparent
Degree of Protection			IP65
Colour			Grey
Module rack			Single-rail
Shroud for protection against accidental contact			Plastic
Rows	Count		1
Module units per row			8
Description			IP65 Protection Class II Plastic enclosure gray (RAL 7035)
Cable entries			Metric cable entries on top and bottom, back plate
PE and N terminals design			Without
Equipment supplied			Basic device Device support rails Locking screws can be sealed Sealing caps Current circuit designation

### Technical data

#### General

Standards			EN 62208, IEC/EN 60670-24
RoHS (in accordance with Directive 2002/95/EC of the European Parliament and Council)			conform
Ambient temperature		°C	-25 - +40
Degree of Protection			IP65
Protection class			II (totally insulated)
Rated operational voltage	U <sub>e</sub>	V AC	415
Rated frequency	f	Hz	50

#### Material characteristics

Material			ABS (plastic)
Colour			Gray (RAL 7035)

#### Material properties

Mechanical			
Impact resistance			IK08

### Design verification as per IEC/EN 61439

Technical data for design verification			
Heat dissipation, at an ambient temperature of 35°C, delta T: 20 degrees, calculated as per IEC 60890			
Individual enclosure for wall mounting	P <sub>v</sub>	CO	14
Heat dissipation, at an ambient temperature of 35°C, delta T: 35 degrees, calculated as per IEC 60890			
Individual enclosure for wall mounting	P <sub>v</sub>	CO	29
IEC/EN 61439 design verification			
10.2 Strength of materials and parts			
10.2.2 Corrosion resistance			Meets the product standard's requirements.
10.2.3.1 Verification of thermal stability of enclosures			Meets the product standard's requirements.

10.2.3.2 Verification of resistance of insulating materials to normal heat		Meets the product standard's requirements.
10.2.3.3 Verification of resistance of insulating materials to abnormal heat and fire due to internal electric effects		650 °C; meets the product standard's requirements.
10.2.4 Resistance to ultra-violet (UV) radiation		Not relevant to indoor installations.
10.2.5 Lifting		Does not apply to enclosures without lifting aids.
10.2.6 Mechanical impact		IK08
10.2.7 Inscriptions		Meets the product standard's requirements.
10.3 Degree of protection of ASSEMBLIES		IP65
10.4 Clearances and creepage distances		Is the panel builder's responsibility.
10.5 Protection against electric shock		Protection class 2, therefore not applicable.
10.6 Incorporation of switching devices and components		Is the panel builder's responsibility.
10.7 Internal electrical circuits and connections		Is the panel builder's responsibility.
10.8 Connections for external conductors		Is the panel builder's responsibility.
10.9 Insulation properties		
10.9.2 Power-frequency electric strength		$U_i = 1000 \text{ V AC}$
10.9.3 Impulse withstand voltage		3.3 kV
10.9.4 Testing of enclosures made of insulating material		Meets the product standard's requirements.
10.10 Temperature rise		The panel builder is responsible for the temperature rise calculation. Eaton will provide heat dissipation data for the devices.
10.11 Short-circuit rating		Is the panel builder's responsibility.
10.12 Electromagnetic compatibility		Is the panel builder's responsibility.
10.13 Mechanical function		Meets the product standard's requirements.

## Technical data ETIM 6.0

Distribution boards (EG000023) / Small distribution board (EC000214)

Electric engineering, automation, process control engineering / Electrical installation, device / Electrical distribution system (incl. small distribution board) / Small distribution board (ecl@ss8.1-27-14-24-09 [ACN387008])

Mounting method		Surface mounting
Number of rows		1
Width in number of modular spacings		8
Type of cover		Door
Cover model		With notch
Transparent cover/door		Yes
Material housing		Plastic
Height	mm	231
Width	mm	238
Depth	mm	115
Built-in depth	mm	70
Internal depth	mm	60
DIN-rail		Yes
With mounting plate		No
Extension possible		Yes
EMC-version		No
Colour		Grey
RAL-number		7035
Degree of protection (IP)		IP65
With lock		No

## Dimensions

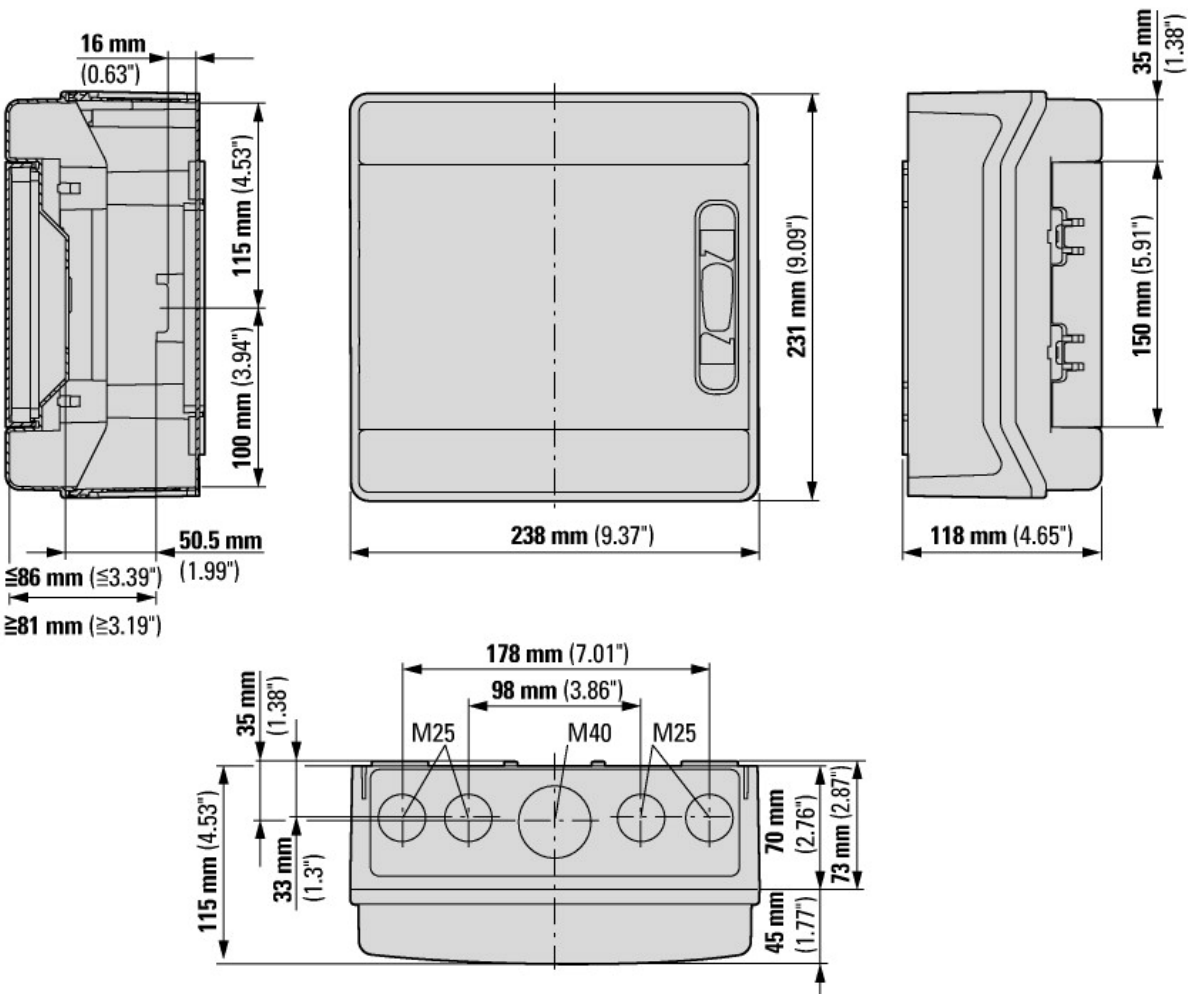
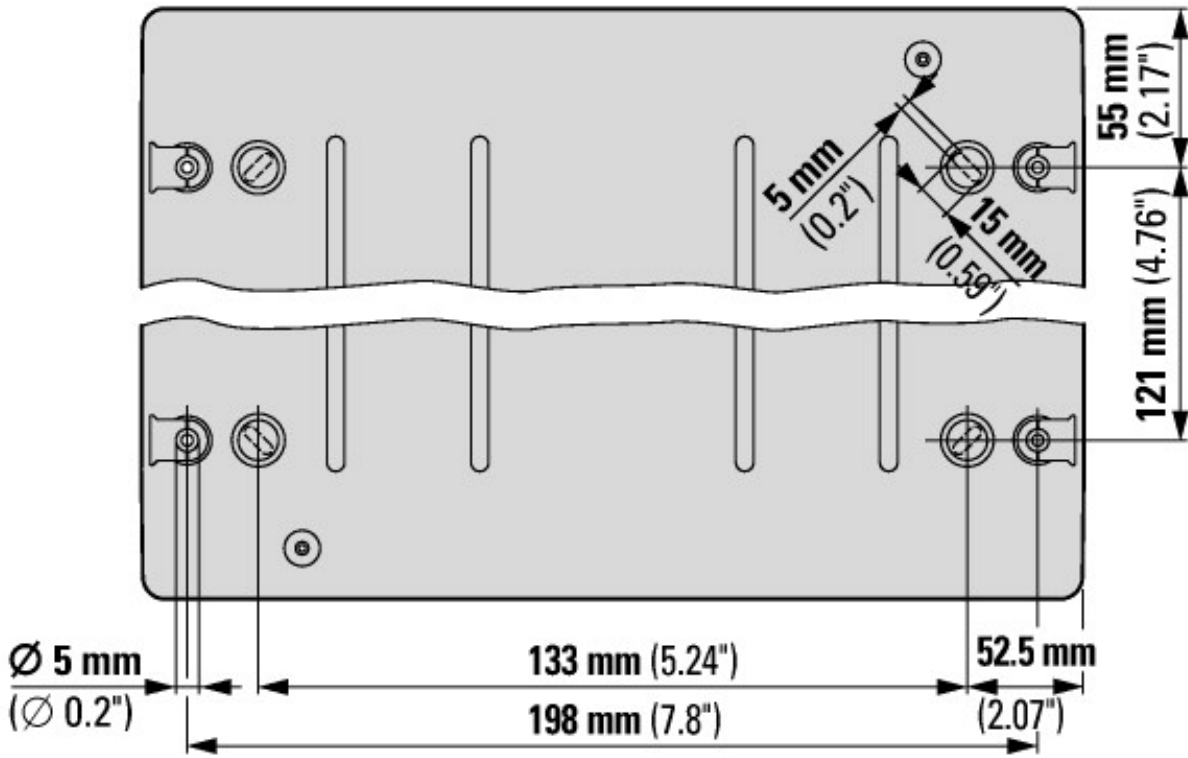

## Additional product information (links)

IL014003Z IKA compact distribution board

IL014003Z IKA compact distribution board

Product overview (Web)

[ftp://ftp.moeller.net/DOCUMENTATION/AWA\\_INSTRUCTIONS/IL014003ZU2015\\_03.pdf](ftp://ftp.moeller.net/DOCUMENTATION/AWA_INSTRUCTIONS/IL014003ZU2015_03.pdf)

<http://www.eaton.eu/DE/Europe/Electrical/ProductsServices/Residential/index.htm>

