

PRODUKT DATABLAD QTi DALI-T/E 2X18...42 DIM

QUICKTRONIC INTELLIGENT DALI DIM CFL | ECG dimbar DALI for CFL



BRUKSOMRÅDER

- Passer for bruk i nødlyssystemer i henhold til EN 50172/DIN VDE 0108-100
- Installering i nødlyssystemer iht. IEC 61347-2-13, tillegg J
- Åpne kontorlandskap, korridorer og lagerrom
- Offentlige bygninger
- Egnet for armaturer med beskyttelsesklasse I

PRODUKTFORDELER

- System+ garanti tilgjengelig
- Enkel integrasjon i armaturer takket være samme dimensjoner som DALI GI ECG

TOUCH DIM OG TOUCH DIM-SENSORFUNKSJON

- Manuell dimming uten kontroller og med standardbrytere
- Inkludert minnefunksjon (dobbelklikk) og myk start

PRODUKTEGENSKAPER

- Korridorfunksjon for direkte tilkobling av ECG til vanlig bevegelsesdetektor
- Korridorfunksjon med forhåndsprogrammert lysprogram
- TouchDIM-funksjon for fri parametrisering av lysverdi og tid for tenning
- Egnet for SMART GRID for rapportering av hovedstrømforbruk og lampens driftstimer
- Veldig lav effekt ved standby: < 0,2 W (A1 BAT)
- Levetid: > 100,000 t (for T = 65 °C ved T_c)
- Svært mange tenninger: Inntil 300 000
- Dimmeområde: 1...100 % (3...100 % med kompaktlysrør)
- POWER2LAMP-funksjon for optimal tilpassing av ECG-effekt til lampe gjennom lampens levetid

– Nettfrekvens: 0 Hz, 50...60 Hz, likerettet vekselspanning

TEKNISK DATA

Elektriske data

Nominell spenning	220...240 V
Nettfrekvensen	50...60 Hz
Likespenning	154...276 V
Driftfrekvens	42...130 kHz
Maksimalt antall ECG på sikring 10 A (B)	8 ¹⁾
Maksimalt antall ECG på sikring 16 A (B)	13 ¹⁾
Startstrøm	45 A

¹⁾ Type B

Lystekniske data

Starttid	0,6 s
-----------------	-------

Mål og vekt

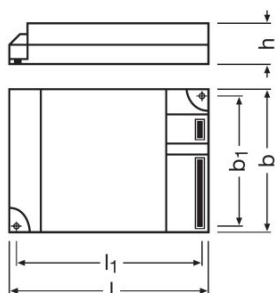

Lengde	123,0 mm
Bredde	79,0 mm
Høyde	33,0 mm
Avstand monteringshull, lengderetning	129,5 mm
Avstand monteringshull, bredde	67,0 mm
Produktvekt	247,00 g
Ledning klargjøringslengde, primærside	8,5...9,5 mm ¹⁾
Ledning klargjøringslengde, sekundærside	8,5...9,5 mm ¹⁾
Kabelverrsnitt, primærside	0,5...1,5 mm ²

¹⁾ Ledningstverrsnitt for instikkskontakter: 0.5...1.5 mm²

Temperatures & operating conditions

Omgivelsestemperatur-område	+10...+50 °C
------------------------------------	--------------

Tillatt relativ fuktighet ved drift	5...85 %
--	----------

Levetid

ECG levetid	100000 h ¹⁾
--------------------	------------------------

¹⁾ Ved Tcase = 65°C ved tc punkt / 10% utfallsprosent

Produktnavn	Lampegruppe				
QTi DALI-T/E 2X18...42 DIM	DULUX D/E 26 W	ECG omgivelsestemperatur [ta]	40	50	60
		temperatur på tc-punkt [° C]	60	70	75
		levetid [t]	100000	100000	80000
	DULUX L 24 W	ECG omgivelsestemperatur [ta]	40	50	60
		temperatur på tc-punkt [° C]	60	70	75
		levetid [t]	100000	100000	80000
	DULUX L 40 W	ECG omgivelsestemperatur [ta]	40	50	60
		temperatur på tc-punkt [° C]	60	70	75
		levetid [t]	100000	100000	80000
	DULUX T/E 18 W	ECG omgivelsestemperatur [ta]	40	50	60
		temperatur på tc-punkt [° C]	55	65	70
		levetid [t]	100000	100000	100000
	DULUX T/E 26 W	ECG omgivelsestemperatur [ta]	40	50	60
		temperatur på tc-punkt [° C]	60	70	75
		levetid [t]	100000	100000	80000
	DULUX T/E 26 W CONSTANT	ECG omgivelsestemperatur [ta]	40	50	60
		temperatur på tc-punkt [° C]	60	70	75
		levetid [t]	100000	100000	80000
	DULUX T/E 42 W	ECG omgivelsestemperatur [ta]	40	50	60
		temperatur på tc-punkt [° C]	60	70	75
		levetid [t]	100000	100000	80000
	DULUX T/E 42 W CONSTANT	ECG omgivelsestemperatur [ta]	40	50	60
		temperatur på tc-punkt [° C]	60	70	75
		levetid [t]	100000	100000	80000
FC 22 W	ECG omgivelsestemperatur [ta]	40	50	60	
	temperatur på tc-punkt [° C]	60	70	75	
	levetid [t]	100000	100000	80000	
FC 40 W	ECG omgivelsestemperatur [ta]	40	50	60	
	temperatur på tc-punkt [° C]	60	70	75	
	levetid [t]	100000	100000	80000	

Ytterligere produktdata

Fotnote bare for produktet	Ekstra kabelklemme, se kapittel om ECG festeordning - kabelklemm
-----------------------------------	--

Egenskaper

Dimmingsgrensesnitt	DALI / Touch DIM / Touch DIM Sensor
Dimmingsområde	3...100 % ¹⁾
Dimbar	Yes
Overopphetningsbeskyttelse	Ja
Egnet armaturer med beskyttelsesklasse	I
Veiligheidsuitschakeling bij einde duur	EOL T.2

¹⁾ Luminous flux

Sertifikater og standarder

Godkjenningmerke - godkjenning	VDE / VDE-EMC / ENEC 10 / EL / GOST / RCM / CCC
Standarder	Acc. to EN 61347-2-3/Acc. to EN 60929/Acc. to EN 55015:2006 + A1:2007/Acc. to EN 61000-3-2/Acc. to EN 61547/Acc. to IEC 62386-101:Ed1/Acc. to IEC 62386-102:Ed1
EEI – Energimerke	A1 BAT
Beskyttelsesklasse	I
Beskyttelses type	IP20

Koblingsskjema

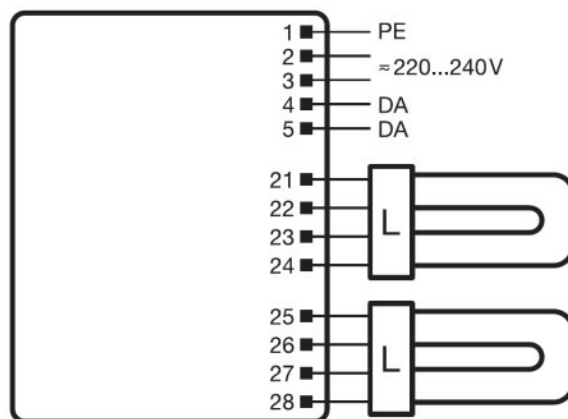
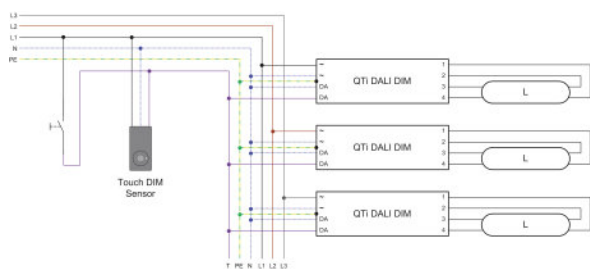

Wiring diagram



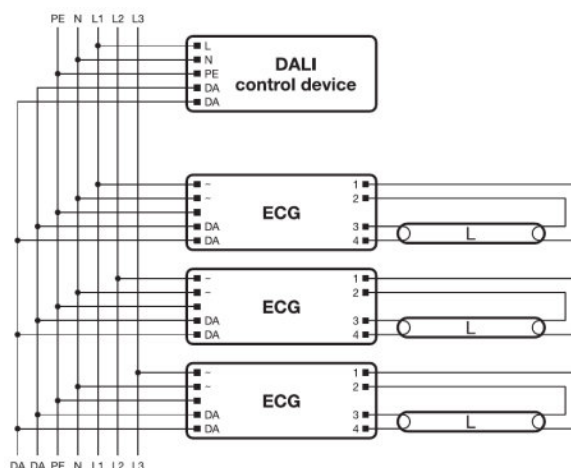
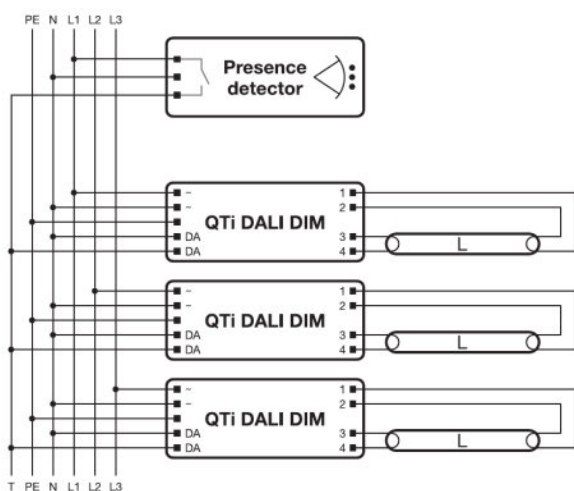









Wiring diagram











Wiring diagram

Wiring diagram

LAST NED DATA

Fil	
	Addon Technical Information 502689_Frequent switching Quicktronic
	Addon Technical Information 502785_ECG lifetime - QUICKTRONIC (DALI) DIM
	Brochures 333874_Bochure – DALI partner
	Certificates 334953_EMC-Marks approval
	Certificates 335097_INOTEC
	Certificates 335125_ENECVDE-Marks approval
	Certificates 335135_Manufacturer's declaration – Burning-in of fluorescent lamps
	Certificates 335153_Manufacturer's declaration – Low stand-by
	Certificates 335154_Manufacturer's declaration – EN 55015:2006+A1:2007 (300 MHz)
	Certificates 335160_Manufacturer's declaration – Lamp T5 FC QTl-TE DALI...DIM ECG combinations
	Certificates 335169_Manufacturer's declaration – LampECG combinations: Frequent switching
	Certificates 335190_Manufacturer's declaration –Additional hints

	Certificates 504208_VDE-EMC-CERTIFICATE QTI DALI DIM
	Declarations of conformity 334767_Declaration of conformity
	Installation/Operation notice 493509_Technical application guide QUICKTRONIC Intelligent DALI DIM (GB)
	Operating instructions 596666_EAC QTi DALI TE DIM
	CAD data 3-dim 321614_QTi DALI-TE 2x18-42 DIM
	CAD data 3-dim 321621_QTi DALI-TE 2x18-42 DIM
	CAD data 3-dim 321622_QTi DALI-TE 2x18-42 DIM
	CAD data PDF 321623_Ti DALI-TE 2x18-42 DIM

LOGISTIKK DATA

Product kode	Produkt beskrivelse	Forpakkings enhet (stk/enhet)	Dimensjoner (lengde x bredde x høyde)	Volum	Brutto vekt
4008321060822	QTI DALI-T/E 2X18...42 DIM	NO: VS 20	428 mm x 78 mm x 257 mm	8.58 dm ³	4700.00 g

The mentioned product code describes the smallest quantity unit which can be ordered. One shipping unit can contain one or more single products. When placing an order, for the quantity please enter single or multiples of a shipping unit.

REFERANSER / LENKER

For mer informasjon om systemgarantien samt vilkårene og betingelsene i garantien besøk

▶ www.ledvance.com/system-guarantee

ANSVARFRASKRIVELSE

Endres uten varsel. Sørg alltid for å bruke den nyeste versjonen.

QUICKTRONIC INTELLIGENT DALI DIM CFL | ECG dimbar DALI for CFL

Produktnavn	Lampeggruppe	Effekttap	Nominell strøm	Lysstrøm ved 25 °C	Antall belysningsutganger	Lysstrøm ved 35 °C
QTi DALI-T/E 2X18...42 DIM	DULUX D/E 18 W	38.00 W	0.17 A	2*1200 lm	2	
	DULUX D/E 26 W	56.00 W	0.25 A	2*1800 lm	2	
	DULUX L 24 W	51.00 W	0.22 A		2	1200 lm
	DULUX L 40 W	87.00 W	0.38 A		2	3500 lm
	DULUX T/E 18 W	38.00 W	0.17 A	1200 lm	2	
	DULUX T/E 26 W	56.00 W	0.25 A	1800 lm	2	
	DULUX T/E 26 W CONSTANT	56.00 W	0.25 A	1800 lm	2	
	DULUX T/E 32 W	69.00 W	0.30 A	2400 lm	2	
	DULUX T/E 32 W CONSTANT	69.00 W	0.30 A	2400 lm	2	
	DULUX T/E 42 W	90.00 W	0.39 A	3200 lm	2	
	DULUX T/E 42 W CONSTANT	90.00 W	0.39 A	3200 lm	2	
	FC 22 W	51.00 W	0.22 A		2	1800 lm
	FC 40 W	87.00 W	0.38 A		2	3200 lm