





ALPHA 400 DIN,
WALL-MOUNTING DISTRIBUTOR,
DELIVERY FORM FLAT PACK, AP-CUBICLE,
RAL 9016, IP43, SK2, H=1400 W=800 D=210

Similar to image

Technical data:

Height	mm	1,400
Width	mm	800
Depth	mm	210
Protection class IP		IP43
Design of the cap/top cover		closed
RAL color number		9016
Mounting depth	mm	210
Surface processing		powder-coated
Acceptability for application / for outside use		No
Material / of the enclosure		sheet steel/plastic
Product component / cable entry		Yes
Product component / Mounting plate		No
Product extension / optional / Sequence		Yes
Suitability for interaction / lightning protection		No

Certificates/approvals:

General Product Approval	Declaration of Conformity	Test Certificates
 GOST	 EG-Konf.	Type Test Certificates/Test Report

Further information:

Information- and Downloadcenter (Catalogs, Brochures,...)

<http://www.siemens.com/lowvoltage/catalogs>

Industry Mall (Online ordering system)

<http://www.siemens.com/lowvoltage/mall>

Service&Support (Manuals, Certificates, Characteristics, FAQs,...)

<http://support.automation.siemens.com/WW/view/en/8GK1112-7KK32/all>

Image database (product images, 2D dimension drawings, 3D models, device circuit diagrams, ...)

http://www.automation.siemens.com/bilddb/cax_en.aspx?mlfb=8GK1112-7KK32

CAX-Online-Generator

<http://www.siemens.com/cax>

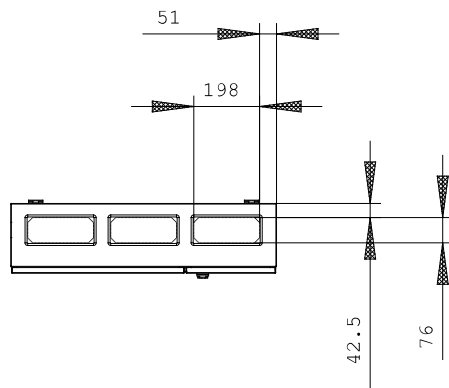
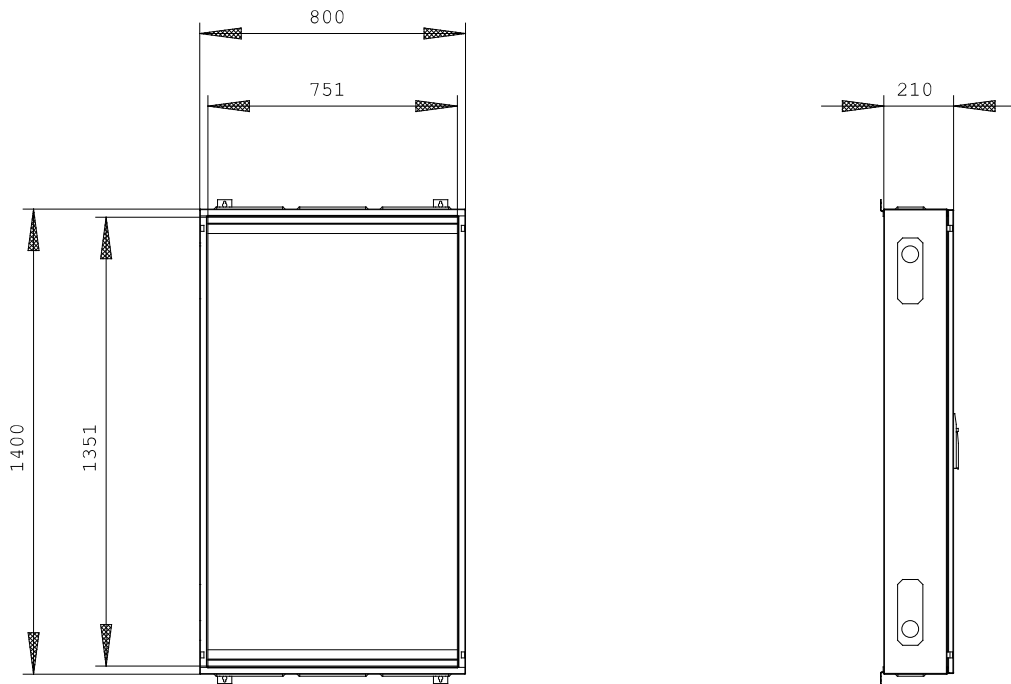

last change:

Oct 8, 2012