





ALPHA 400 DIN,  
WALL-MOUNTING DISTRIBUTOR,  
DELIVERY FORM FLAT PACK, AP-CUBICLE,  
RAL 9016, IP43, SK1, H=1400 W=800 D=210

Similar to image

#### Technical data:

<b>Height</b>	mm	1,400
<b>Width</b>	mm	800
<b>Depth</b>	mm	210
<b>Protection class IP</b>		IP43
<b>Design of the cap/top cover</b>		closed
<b>RAL color number</b>		9016
<b>Mounting depth</b>	mm	210
<b>Surface processing</b>		powder-coated
<b>Acceptability for application / for outside use</b>		No
<b>Material / of the enclosure</b>		sheet steel/plastic
<b>Product component / cable entry</b>		Yes
<b>Product component / Mounting plate</b>		No
<b>Product extension / optional / Sequence</b>		Yes
<b>Suitability for interaction / lightning protection</b>		No

#### Certificates/approvals:

General Product Approval	Declaration of Conformity	Test Certificates
 GOST	 EG-Konf.	<a href="#">Type Test Certificates/Test Report</a>

#### Further information:

##### Information- and Downloadcenter (Catalogs, Brochures,...)

<http://www.siemens.com/lowvoltage/catalogs>

##### Industry Mall (Online ordering system)

<http://www.siemens.com/lowvoltage/mall>

##### Service&Support (Manuals, Certificates, Characteristics, FAQs,...)

<http://support.automation.siemens.com/WW/view/en/8GK1102-7KK32/all>

##### Image database (product images, 2D dimension drawings, 3D models, device circuit diagrams, ...)

[http://www.automation.siemens.com/bilddb/cax\\_en.aspx?mlfb=8GK1102-7KK32](http://www.automation.siemens.com/bilddb/cax_en.aspx?mlfb=8GK1102-7KK32)

##### CAX-Online-Generator

<http://www.siemens.com/cax>

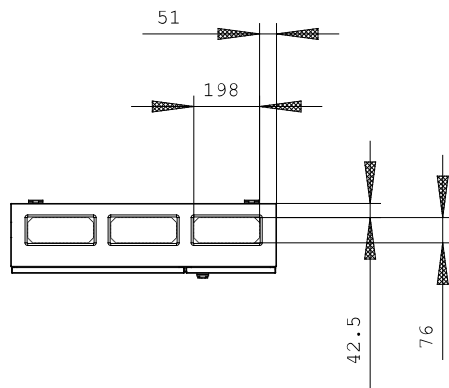
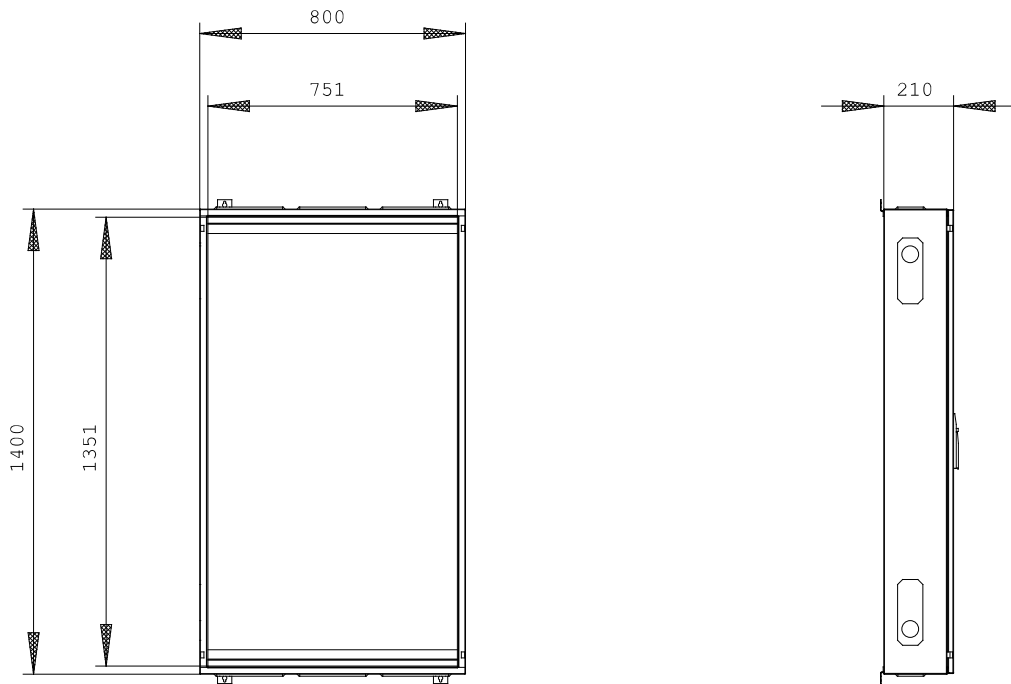

last change:

Oct 8, 2012