



REMOTE SWITCH WITH 2 NO CONTACT FOR AC 230, 400V 16A CONTROL AC 8V

Similar to image

Technical data:

Latching relay design		Mechanical switch
Type of mounting		DIN rail
Number of NC contacts		0
Number of NO contacts		2
Number of change-over switches		0
Width of opening / of contacts	mm	1.2
Stipulated clearance to live parts	mm	6
Switching current / with AC / per contact / minimum	mA	100
Switching voltage / of contacts / with AC / minimum	V	10
type of voltage		AC
Type of voltage / of control voltage_1		AC
Control voltage/ _1 / final value		
• initial value	V	6.4
•	V	8.8
• setpoint	V	8
Operating range factor control supply voltage rated value / at 50 Hz / for AC		
• initial value		0.8

• final value		1.1
Supply voltage	V	250 ... 400
Breaking capacity current		
• nominal value	A	16
• at cos phi 0.6	A	16
Switching capacity real power / for filament lamp load	W	2,000
Switching capacity apparent power		
• for uncorrected fluorescent lamp load	V·A	500
• for fluorescent lamp load with DUO circuit	V·A	900
• for fluorescent lamp load with parallel compensation	V·A	400
Control voltage frequency / _1		
• initial value	Hz	50
• final value	Hz	50
Impulse voltage resistance / rated value	kV	4
Apparent power loss / of magnet coil / with pulse / rated value	V·A	7
Active power loss / at 16 A / per contact / rated value	W	1.2
Number of pitch units for width		1
Product function / direct operation		Yes
Product component / switch position indicator		Yes
Mounting height	mm	90
Mounting depth	mm	70
Galvanic isolation / between magnet coil and contact		Yes
Pulse duration / minimum	ms	50
Electrical endurance (operating cycles)		50,000
Number of terminals		6
Conductor cross section that can be connected		
• for rigid conductor	mm ²	1.5 ... 6
Conductor cross section that can be connected / for flexible conductor		
• with wire end processing	mm ²	1 ... 6
Ambient temperature / with relative humidity 95% / in accordance with DIN 50015	°C	35
Ambient temperature	°C	-10 ... +40
Protection class IP		IP20, with connected conductors
mounting position		any

Certificates/approvals:

General Product Approval

Declaration of
Conformity

other



[Environmental
Confirmations](#)

Further information:

Information- and Downloadcenter (Catalogs, Brochures,...)

<http://www.siemens.com/lowvoltage/catalogs>

Industry Mall (Online ordering system)

<http://www.siemens.com/lowvoltage/mall>

Service&Support (Manuals, Certificates, Characteristics, FAQs,...)

<http://support.automation.siemens.com/WW/view/en/5TT4102-4/all>

Image database (product images, 2D dimension drawings, 3D models, device circuit diagrams, ...)

http://www.automation.siemens.com/bilddb/cax_en.aspx?mlfb=5TT4102-4

CAX-Online-Generator

<http://www.siemens.com/cax>

Tender specifications

[Datanorm GAEB81](#) [GAEB83](#) [RTF](#) [TXT](#)

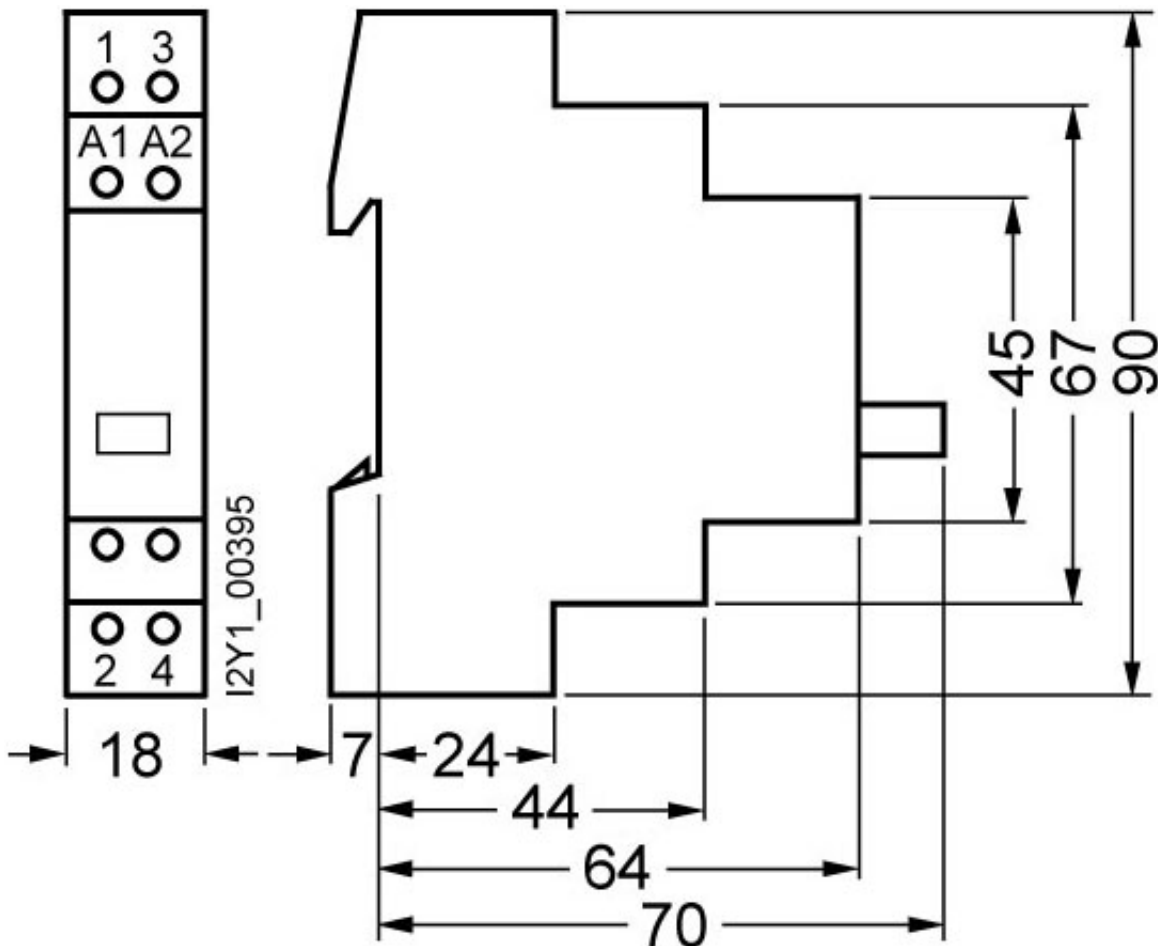

last change:

Mar 18, 2013