

3-PHASE INFEED TERMINAL, FOR 3-PHASE
BUSBARS, CONNECTION FROM ABOVE, SIZE
S00/S0

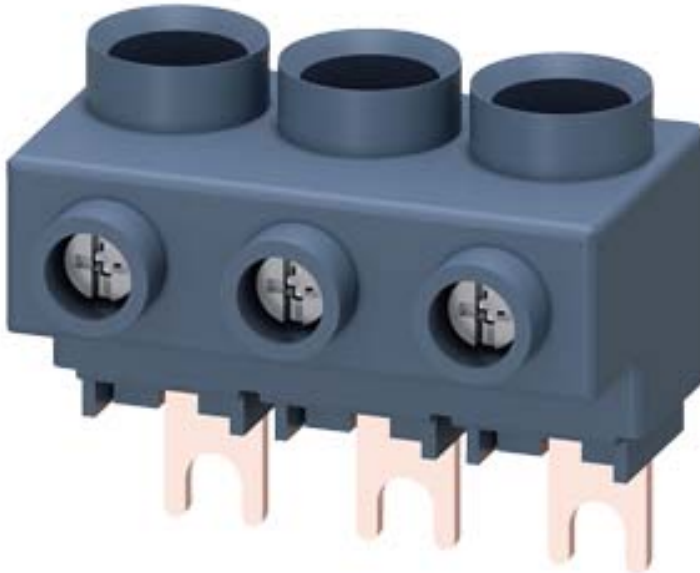

General technical data:

product brandname		SIRIUS
Product designation		Three-phase feeder terminal
Design of the product		from above, size S0/S00
Size of the circuit-breaker		S00, S0
Protection class IP on the front		IP20
Insulation voltage with degree of pollution 3 rated value	V	690
Ambient temperature		
• during storage	°C	-50 ... +80
• during operation	°C	-20 ... +60
Ampacity maximum	A	63

Installation/ mounting/ dimensions:

Width	mm	44.5
Height	mm	39
Depth	mm	27.2

Connections/ Terminals:

Type of electrical connection for main current circuit		screw-type terminals
--	--	----------------------





Type of connectable conductor cross-sections

- for main contacts
 - solid 1x (2.5 ... 16 mm²)
 - stranded 1x (2.5 ... 25 mm²)
 - finely stranded
 - with core end processing 1x (2.5 ... 16 mm²)
- at AWG conductors for main contacts 1x (10 ... 4)

Certificates/ approvals:

Certificate of suitability

CE / UL / CSA / CCC

General Product Approval	Declaration of Conformity	Test Certificates		Shipping Approval
 CSA	 UL	 EG-Konf.	Type Test Certificates/Test Report	Special Test Certificate
				 ABS

Shipping Approval



other

Railway

[Confirmation](#)

[Environmental Confirmations](#)



[Vibration and Shock](#)

Further information

Information- and Downloadcenter (Catalogs, Brochures,...)

<http://www.siemens.com/industrial-controls/catalogs>

Industry Mall (Online ordering system)

<http://www.siemens.com/industrymall>

Cax online generator

<http://support.automation.siemens.com/WW/CAXorder/default.aspx?lang=en&mlfb=3RV2925-5AB>

Service&Support (Manuals, Certificates, Characteristics, FAQs,...)

<https://support.industry.siemens.com/cs/ww/en/ps/3RV2925-5AB>

Image database (product images, 2D dimension drawings, 3D models, device circuit diagrams, EPLAN macros, ...)

http://www.automation.siemens.com/bilddb/cax_de.aspx?mlfb=3RV2925-5AB&lang=en

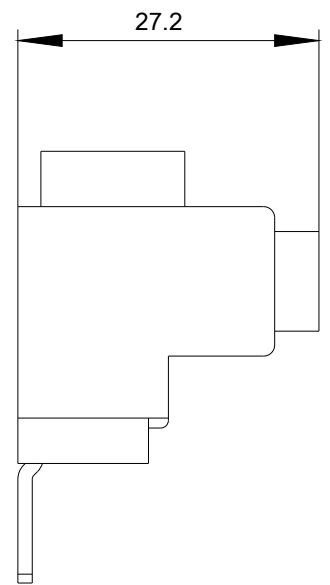
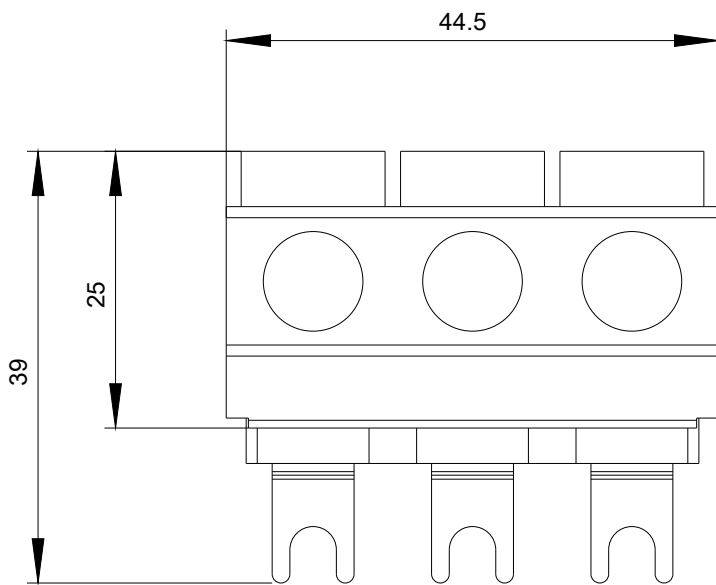

last modified:

05/19/2017