

REMOTE RESET MODULE, ELECTRICAL AC/DC
220...250 V FOR 3RU SIZE S00...S12



General technical data:

product brandname		SIRIUS
Product designation		Electrical RESET
Design of the product		Electrical remote reset
Size of overload relay		S00, S0, S2, S3
Ambient temperature		
<ul style="list-style-type: none"> during storage 	°C	-50 ... +80
<ul style="list-style-type: none"> during operation 	°C	-20 ... +70

Control circuit/ Control:





Type of voltage of the control supply voltage		AC/DC
Control supply voltage frequency		
<ul style="list-style-type: none"> 1 rated value 	Hz	50
<ul style="list-style-type: none"> 2 rated value 	Hz	60
Control supply voltage 1		
<ul style="list-style-type: none"> at DC 		
<ul style="list-style-type: none"> <ul style="list-style-type: none"> Initial rated value 	V	220
<ul style="list-style-type: none"> <ul style="list-style-type: none"> Final rated value 	V	250
<ul style="list-style-type: none"> at AC 		





— at 50 Hz Initial rated value	V	220
— at 50 Hz Final rated value	V	250
— at 60 Hz Final rated value	V	250
— at 60 Hz Initial rated value	V	220

Connections/ Terminals:

Type of electrical connection for auxiliary and control current circuit		screw-type terminals
Type of connectable conductor cross-sections for auxiliary contacts		2x (0.5 ... 1.5 mm ²), 2x (0.75 ... 2.5 mm ²)
<ul style="list-style-type: none"> • solid • finely stranded — with core end processing 		2x (0.5 ... 1.5 mm ²), 2x (0.75 ... 2.5 mm ²)

Certificates/ approvals:

General Product Approval		Declaration of Conformity	Test Certificates		
 CSA	 UL		 EG-Konf.	Type Test Certificates/Test Report	Special Test Certificate

Shipping Approval	other	
 ABS  BUREAU VERITAS  RINA  RMRS	Environmental Confirmations	Confirmation

Further information

Information- and Downloadcenter (Catalogs, Brochures,...)

<http://www.siemens.com/industrial-controls/catalogs>

Industry Mall (Online ordering system)

<http://www.siemens.com/industrymall>

Cax online generator

<http://support.automation.siemens.com/WW/CAXorder/default.aspx?lang=en&mlfb=3RU1900-2AM71>

Service&Support (Manuals, Certificates, Characteristics, FAQs,...)

<https://support.industry.siemens.com/cs/ww/en/ps/3RU1900-2AM71>

Image database (product images, 2D dimension drawings, 3D models, device circuit diagrams, EPLAN macros, ...)

http://www.automation.siemens.com/bilddb/cax_de.aspx?mlfb=3RU1900-2AM71&lang=en

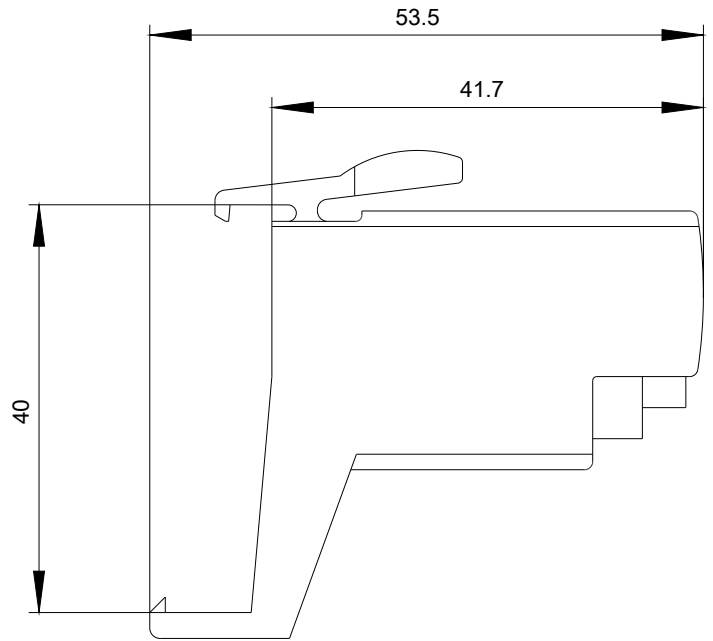
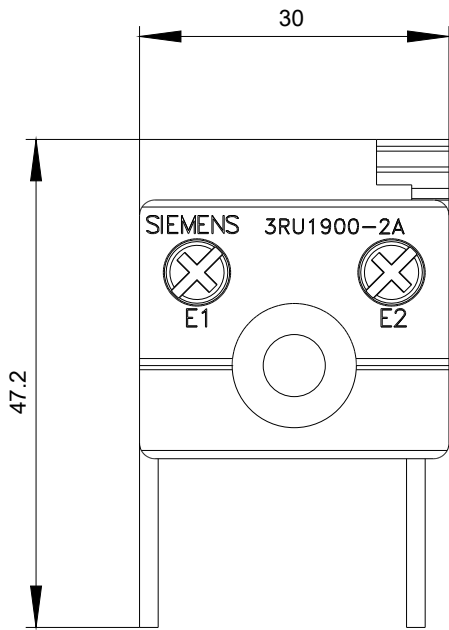

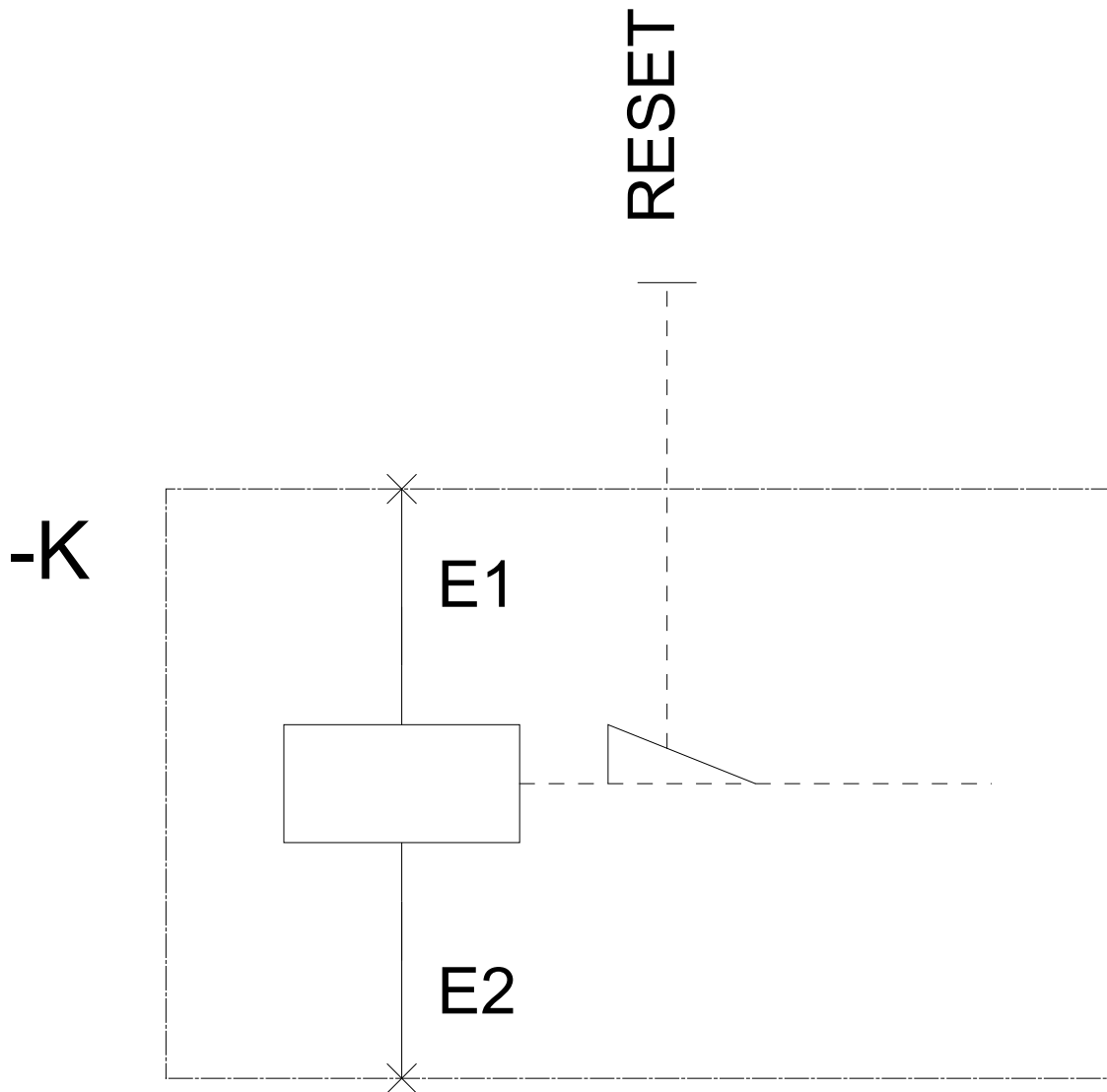

last modified:

07/01/2017