

REMOTE RESET MODULE, ELECTRICAL AC/DC
24...30 V FOR 3RU SIZE S00...S12



Figure similar

General technical data:		
product brandname		SIRIUS
Product designation		Electrical RESET
Design of the product		Electrical remote reset
Size of overload relay		S00, S0, S2, S3
Ambient temperature		
• during storage	°C	-50 ... +80
• during operation	°C	-20 ... +70
Control circuit/ Control:		
Type of voltage of the control supply voltage		AC/DC
Control supply voltage frequency		
• 1 rated value	Hz	50
• 2 rated value	Hz	60
Control supply voltage 1		
• at DC		
— Initial rated value	V	24
— Final rated value	V	30





- at AC
 - at 50 Hz Initial rated value
 - at 50 Hz Final rated value
 - at 60 Hz Final rated value
 - at 60 Hz Initial rated value





V	24
V	30
V	30
V	24

Connections/ Terminals:

Type of electrical connection for auxiliary and control current circuit	screw-type terminals
Type of connectable conductor cross-sections for auxiliary contacts <ul style="list-style-type: none"> • solid • finely stranded <ul style="list-style-type: none"> — with core end processing 	2x (0.5 ... 1.5 mm ²), 2x (0.75 ... 2.5 mm ²) 2x (0.5 ... 1.5 mm ²), 2x (0.75 ... 2.5 mm ²)

Certificates/ approvals:

General Product Approval		Declaration of Conformity	Test Certificates		
 CSA	 UL		 EG-Konf.	Special Test Certificate	Type Test Certificates/Test Report

Shipping Approval	other
 ABS  BUREAU VERITAS  RINA  RMRS	Environmental Confirmations Confirmation

Further information

Information- and Downloadcenter (Catalogs, Brochures,...)

<http://www.siemens.com/industrial-controls/catalogs>

Industry Mall (Online ordering system)

<http://www.siemens.com/industrymall>

Cax online generator

<http://support.automation.siemens.com/WW/CAXorder/default.aspx?lang=en&mfb=3RU1900-2AB71>

Service&Support (Manuals, Certificates, Characteristics, FAQs,...)

<https://support.industry.siemens.com/cs/ww/en/ps/3RU1900-2AB71>

Image database (product images, 2D dimension drawings, 3D models, device circuit diagrams, EPLAN macros, ...)

http://www.automation.siemens.com/bilddb/cax_de.aspx?mfb=3RU1900-2AB71&lang=en

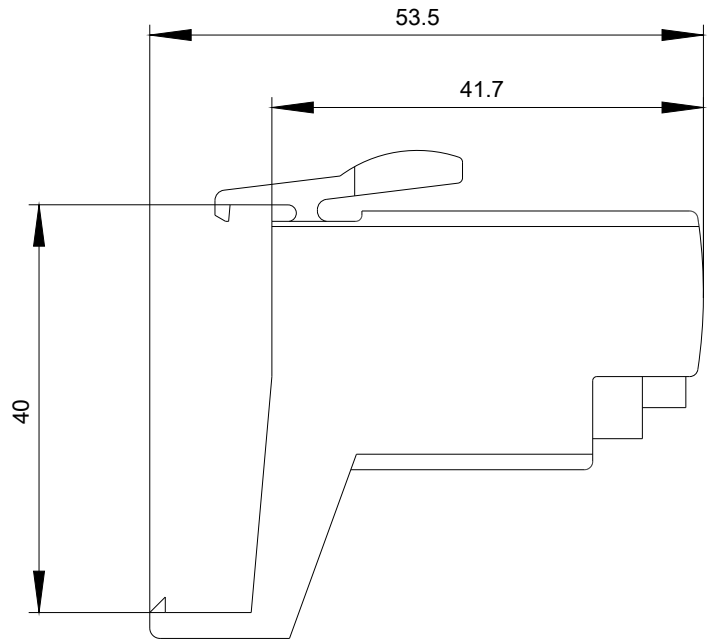
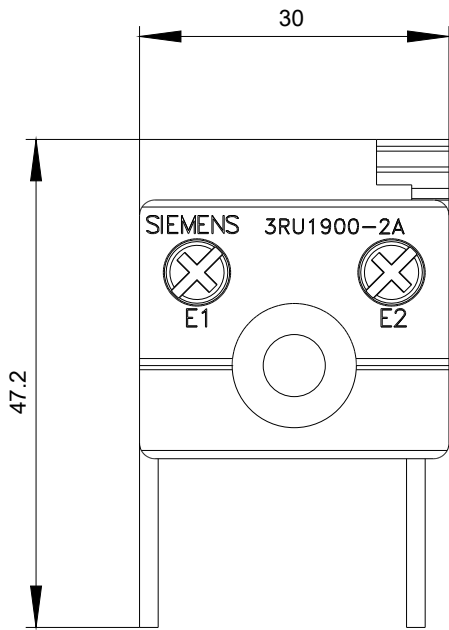

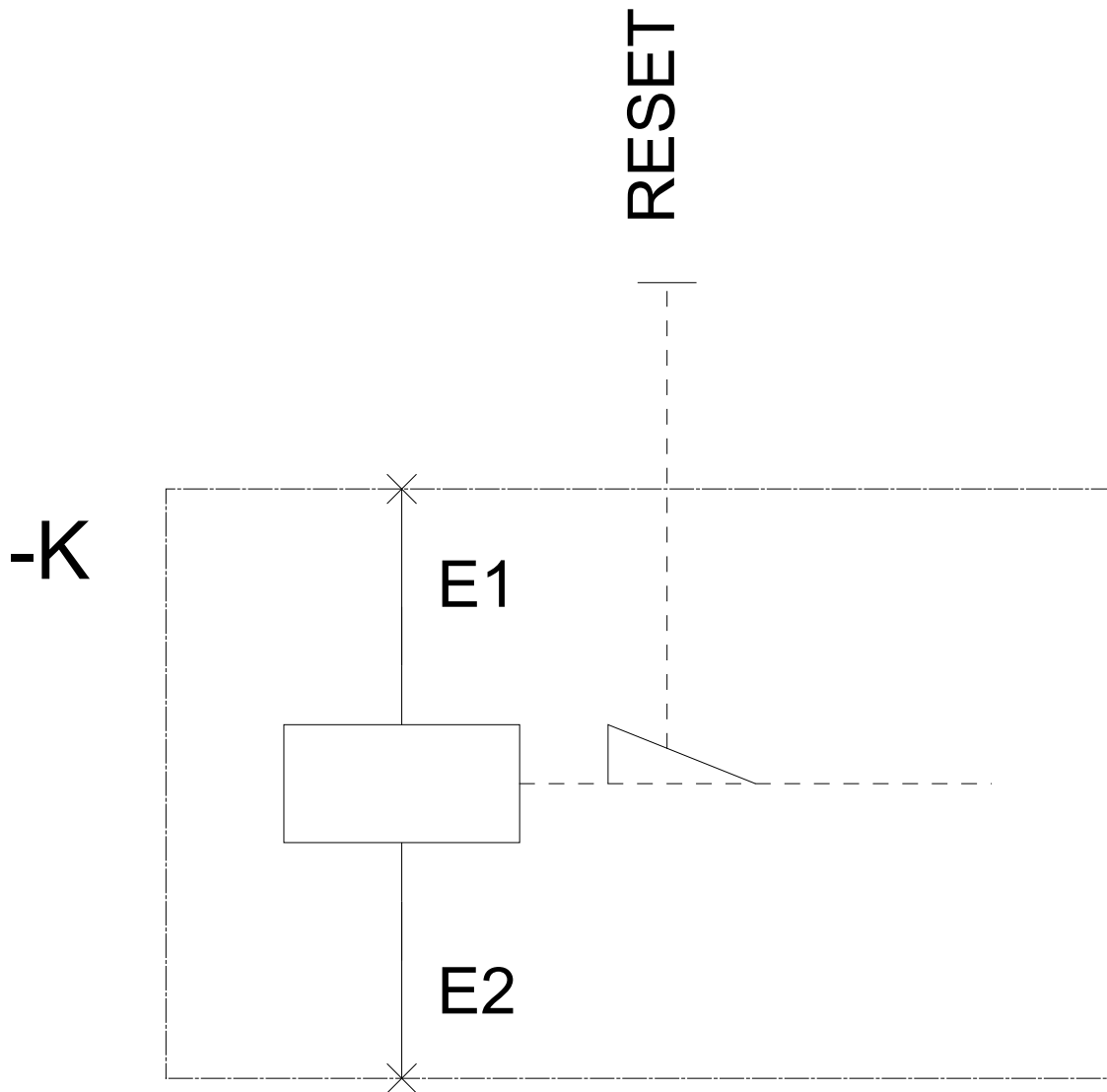

last modified:

07/01/2017