

CONTACTOR, AC-3, 5.5KW/400V, 1NO+1NC, DC 24V, 3-POLE, SZ
S0 SCREW TERMINAL



product brandname	SIRIUS
Product designation	Power contactor
Product type designation	3RT2
General technical data	
Size of contactor	S0
Product extension	
• function module for communication	No
• Auxiliary switch	Yes
Insulation voltage	
• rated value	690 V
Surge voltage resistance rated value	6 kV
maximum permissible voltage for safe isolation	
• between coil and main contacts acc. to EN 60947-1	400 V
Protection class IP	
• on the front	IP20
• of the terminal	IP20
Shock resistance at rectangular impulse	
• at DC	10g / 5 ms, 7,5g / 10 ms

Shock resistance with sine pulse	
<ul style="list-style-type: none"> • at DC 	15g / 5 ms, 10g / 10 ms
Mechanical service life (switching cycles)	
<ul style="list-style-type: none"> • of contactor typical 	10 000 000
<ul style="list-style-type: none"> • of the contactor with added electronics-compatible auxiliary switch block typical 	5 000 000
<ul style="list-style-type: none"> • of the contactor with added auxiliary switch block typical 	10 000 000

Ambient conditions

Ambient temperature	
<ul style="list-style-type: none"> • during operation 	-25 ... +60 °C
<ul style="list-style-type: none"> • during storage 	-55 ... +80 °C

Main circuit

Number of poles for main current circuit	3
Number of NO contacts for main contacts	3
Operating voltage	
<ul style="list-style-type: none"> • at AC-3 rated value maximum 	690 V
Operating current	
<ul style="list-style-type: none"> • at AC-1 at 400 V <ul style="list-style-type: none"> — at ambient temperature 40 °C rated value 	40 A
<ul style="list-style-type: none"> • at AC-1 <ul style="list-style-type: none"> — up to 690 V at ambient temperature 40 °C rated value 	40 A
<ul style="list-style-type: none"> — up to 690 V at ambient temperature 60 °C rated value 	35 A
<ul style="list-style-type: none"> • at AC-2 at 400 V rated value 	12 A
<ul style="list-style-type: none"> • at AC-3 <ul style="list-style-type: none"> — at 400 V rated value 	12 A
<ul style="list-style-type: none"> — at 500 V rated value 	12 A
<ul style="list-style-type: none"> — at 690 V rated value 	9 A
Connectable conductor cross-section in main circuit at AC-1	
<ul style="list-style-type: none"> • at 60 °C minimum permissible 	10 mm ²
<ul style="list-style-type: none"> • at 40 °C minimum permissible 	10 mm ²
Operating current for approx. 200000 operating cycles at AC-4	
<ul style="list-style-type: none"> • at 400 V rated value 	5.5 A
<ul style="list-style-type: none"> • at 690 V rated value 	5.5 A
Operating current	
<ul style="list-style-type: none"> • at 1 current path at DC-1 <ul style="list-style-type: none"> — at 24 V rated value 	35 A
<ul style="list-style-type: none"> — at 110 V rated value 	4.5 A

— at 220 V rated value	1 A
— at 440 V rated value	0.4 A
— at 600 V rated value	0.25 A
• with 2 current paths in series at DC-1	
— at 24 V rated value	35 A
— at 110 V rated value	35 A
— at 220 V rated value	5 A
— at 440 V rated value	1 A
— at 600 V rated value	0.8 A
• with 3 current paths in series at DC-1	
— at 24 V rated value	35 A
— at 110 V rated value	35 A
— at 220 V rated value	35 A
— at 440 V rated value	2.9 A
— at 600 V rated value	1.4 A
Operating current	
• at 1 current path at DC-3 at DC-5	
— at 24 V rated value	20 A
— at 110 V rated value	2.5 A
— at 220 V rated value	1 A
— at 440 V rated value	0.09 A
— at 600 V rated value	0.06 A
• with 2 current paths in series at DC-3 at DC-5	
— at 24 V rated value	35 A
— at 110 V rated value	15 A
— at 220 V rated value	3 A
— at 440 V rated value	0.27 A
— at 600 V rated value	0.16 A
• with 3 current paths in series at DC-3 at DC-5	
— at 24 V rated value	35 A
— at 110 V rated value	35 A
— at 220 V rated value	10 A
— at 440 V rated value	0.6 A
— at 600 V rated value	0.6 A
Operating power	
• at AC-1	
— at 230 V rated value	13.3 kW
— at 230 V at 60 °C rated value	13.3 kW
— at 400 V rated value	23 kW
— at 400 V at 60 °C rated value	23 kW
— at 690 V rated value	40 kW

<ul style="list-style-type: none"> — at 690 V at 60 °C rated value 	40 kW
<ul style="list-style-type: none"> • at AC-2 at 400 V rated value 	5.5 kW
<ul style="list-style-type: none"> • at AC-3 <ul style="list-style-type: none"> — at 230 V rated value — at 400 V rated value — at 690 V rated value 	3 kW 5.5 kW 7.5 kW
Operating power for approx. 200000 operating cycles at AC-4	
<ul style="list-style-type: none"> • at 400 V rated value • at 690 V rated value 	2.6 kW 4.6 kW
Thermal short-time current limited to 10 s	110 A
Power loss [W] at AC-3 at 400 V for rated value of the operating current per conductor	0.5 W
No-load switching frequency	
<ul style="list-style-type: none"> • at DC 	1 500 1/h
Operating frequency	
<ul style="list-style-type: none"> • at AC-1 maximum • at AC-2 maximum • at AC-3 maximum • at AC-4 maximum 	1 000 1/h 1 000 1/h 1 000 1/h 300 1/h

Control circuit/ Control	
Type of voltage of the control supply voltage	DC
Control supply voltage at DC	
<ul style="list-style-type: none"> • rated value 	24 V
Closing power of magnet coil at DC	5.9 W
Holding power of magnet coil at DC	5.9 W
Closing delay	
<ul style="list-style-type: none"> • at DC 	50 ... 170 ms
Opening delay	
<ul style="list-style-type: none"> • at DC 	15 ... 17.5 ms
Arcing time	10 ... 10 ms
Residual current of the electronics for control with signal <0>	
<ul style="list-style-type: none"> • at AC at 230 V maximum permissible • at DC at 24 V maximum permissible 	6 mA 16 mA

Auxiliary circuit	
Number of NC contacts	
<ul style="list-style-type: none"> • for auxiliary contacts <ul style="list-style-type: none"> — instantaneous contact 	1
Number of NO contacts	
<ul style="list-style-type: none"> • for auxiliary contacts <ul style="list-style-type: none"> — instantaneous contact 	1

Operating current at AC-12 maximum	10 A
Operating current at AC-15	
• at 230 V rated value	10 A
• at 400 V rated value	3 A
• at 500 V rated value	2 A
• at 690 V rated value	1 A
Operating current at DC-12	
• at 24 V rated value	10 A
• at 48 V rated value	6 A
• at 60 V rated value	6 A
• at 110 V rated value	3 A
• at 125 V rated value	2 A
• at 220 V rated value	1 A
• at 600 V rated value	0.15 A
Operating current at DC-13	
• at 24 V rated value	10 A
• at 48 V rated value	2 A
• at 60 V rated value	2 A
• at 110 V rated value	1 A
• at 125 V rated value	0.9 A
• at 220 V rated value	0.3 A
• at 600 V rated value	0.1 A
Contact reliability of auxiliary contacts	1 faulty switching per 100 million (17 V, 1 mA)

UL/CSA ratings

Full-load current (FLA) for three-phase AC motor	
• at 480 V rated value	11 A
• at 600 V rated value	11 A
Yielded mechanical performance [hp]	
• for single-phase AC motor	
— at 110/120 V rated value	1 hp
— at 230 V rated value	2 hp
• for three-phase AC motor	
— at 200/208 V rated value	3 hp
— at 220/230 V rated value	3 hp
— at 460/480 V rated value	7.5 hp
— at 575/600 V rated value	10 hp
Contact rating of auxiliary contacts according to UL	A600 / Q600

Short-circuit protection

Design of the fuse link	
• for short-circuit protection of the main circuit	
— with type of coordination 1 required	gG NH 3NA, DIAZED 5SB, NEOZED 5SE: 63 A

- with type of assignment 2 required
- for short-circuit protection of the auxiliary switch required

gG NH 3NA, DIAZED 5SB, NEOZED 5SE: 25 A
fuse gG: 10 A

Installation/ mounting/ dimensions

Mounting position	+/-180° rotation possible on vertical mounting surface; can be tilted forward and backward by +/- 22.5° on vertical mounting surface
Mounting type	screw and snap-on mounting onto 35 mm standard mounting rail according to DIN EN 60715
<ul style="list-style-type: none"> • Side-by-side mounting 	Yes
Height	85 mm
Width	45 mm
Depth	107 mm
Required spacing	
<ul style="list-style-type: none"> • for grounded parts <ul style="list-style-type: none"> — at the side • for live parts <ul style="list-style-type: none"> — at the side 	6 mm
	6 mm

Connections/Terminals





Type of electrical connection	
<ul style="list-style-type: none"> • for main current circuit • for auxiliary and control current circuit 	screw-type terminals screw-type terminals
Type of connectable conductor cross-sections	
<ul style="list-style-type: none"> • for main contacts <ul style="list-style-type: none"> — solid — single or multi-stranded — finely stranded with core end processing • at AWG conductors for main contacts 	2x (1 ... 2.5 mm ²), 2x (2.5 ... 10 mm ²) 2x (1 ... 2,5 mm ²), 2x (2,5 ... 10 mm ²) 2x (1 ... 2.5 mm ²), 2x (2.5 ... 6 mm ²), 1x 10 mm ² 2x (16 ... 12), 2x (14 ... 8)
Type of connectable conductor cross-sections	
<ul style="list-style-type: none"> • for auxiliary contacts <ul style="list-style-type: none"> — single or multi-stranded — finely stranded with core end processing • at AWG conductors for auxiliary contacts 	2x (0,5 ... 1,5 mm ²), 2x (0,75 ... 2,5 mm ²) 2x (0.5 ... 1.5 mm ²), 2x (0.75 ... 2.5 mm ²) 2x (20 ... 16), 2x (18 ... 14)



Safety related data

B10 value	
<ul style="list-style-type: none"> • with high demand rate acc. to SN 31920 	1 000 000
Proportion of dangerous failures	
<ul style="list-style-type: none"> • with low demand rate acc. to SN 31920 • with high demand rate acc. to SN 31920 	40 % 73 %
Failure rate [FIT]	
<ul style="list-style-type: none"> • with low demand rate acc. to SN 31920 	100 FIT

Product function	Yes
• Mirror contact acc. to IEC 60947-4-1	
T1 value for proof test interval or service life acc. to IEC 61508	20 y
Protection against electrical shock	finger-safe

Certificates/approvals

General Product Approval					EMC
 CCC	 CSA	 UL	KC		 C-Tick

Functional Safety/Safety of Machinery	Declaration of Conformity	Test Certificates	Shipping Approval	
Type Examination	 EG-Konf.	Special Test Certificate	Type Test Certificates/Test Report	 ABS
				 BUREAU VERITAS

Shipping Approval					other
 GL	 LRS	 PRS	 RINA	 RMRS	Environmental Confirmations

other
Confirmation
 VDE

Further information

Information- and Downloadcenter (Catalogs, Brochures,...)

<http://www.siemens.com/industrial-controls/catalogs>

Industry Mall (Online ordering system)

<https://mall.industry.siemens.com/mall/en/en/Catalog/product?mlfb=3RT2024-1BB40>

Cax online generator

<http://support.automation.siemens.com/WW/CAXorder/default.aspx?lang=en&mlfb=3RT2024-1BB40>

Service&Support (Manuals, Certificates, Characteristics, FAQs,...)

<https://support.industry.siemens.com/cs/ww/en/ps/3RT2024-1BB40>

Image database (product images, 2D dimension drawings, 3D models, device circuit diagrams, EPLAN macros, ...)

http://www.automation.siemens.com/bilddb/cax_de.aspx?mlfb=3RT2024-1BB40&lang=en

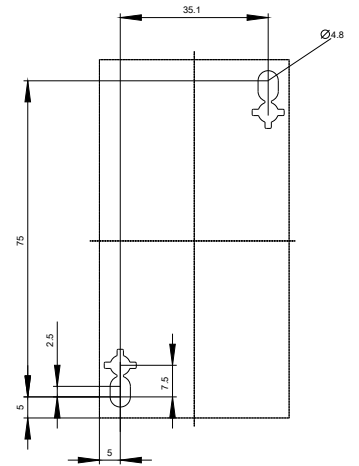
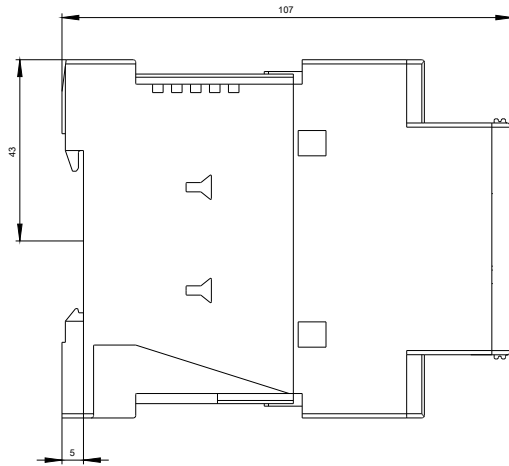
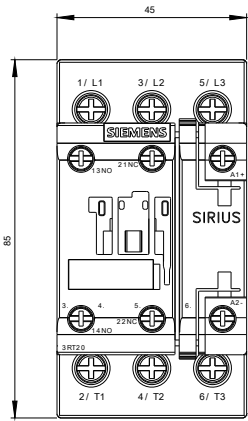

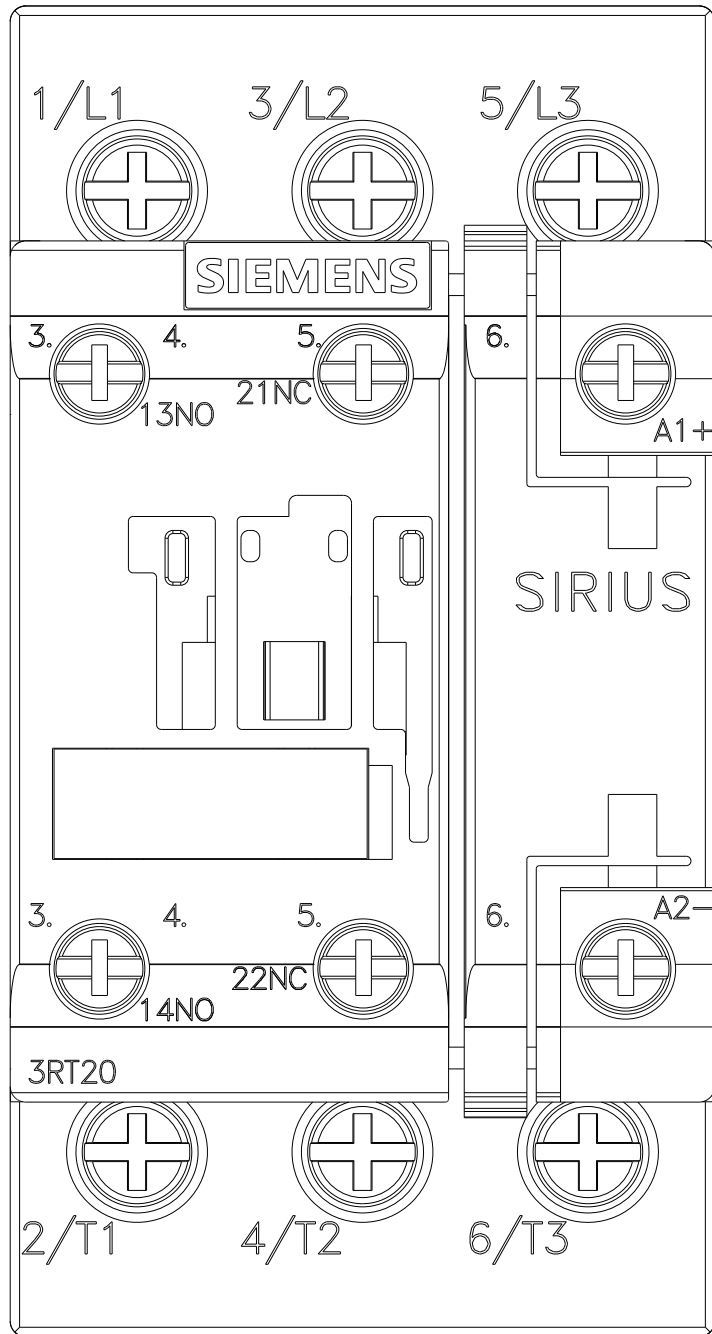

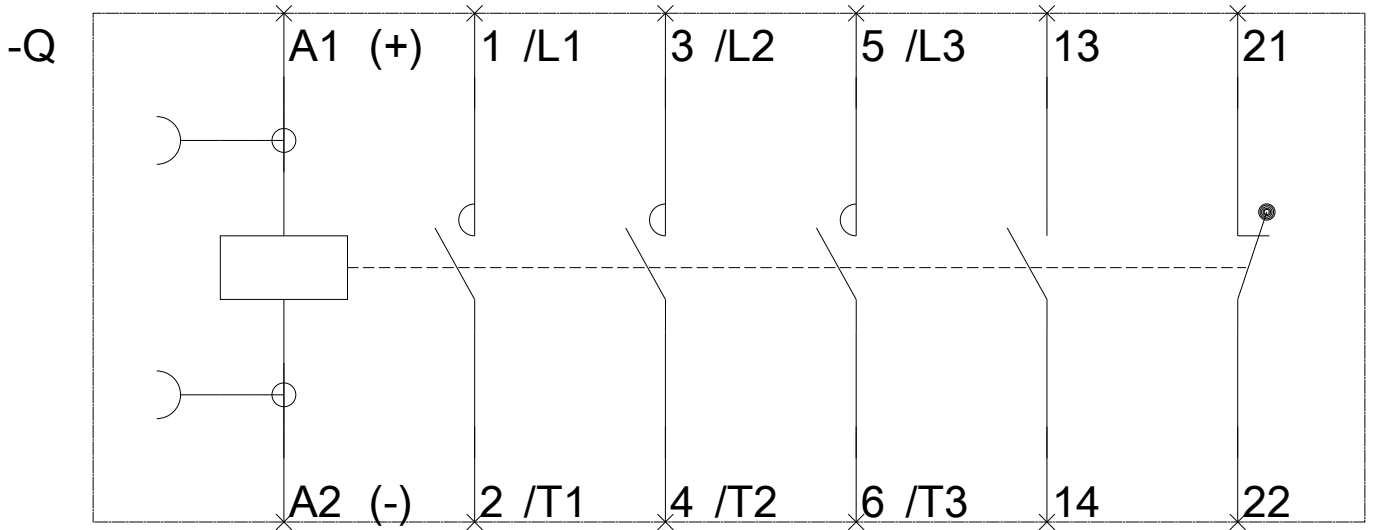

last modified:

06/20/2017