

LATERAL AUX.SWITCH BLOCK,SIDE, 2NO, CURR.PATH: 1NO,
1NO, FOR MOTOR CONTACTORS, SZ S00, SCREW TERMINAL
R: 23/24, 33/34 L :43/44, 53/54



General technical data	
product brandname	SIRIUS
Suitability for use	Contactor relay and power contactor
Protection class IP on the front	IP20
Ambient temperature	
• during storage	-55 ... +80 °C
• during operation	-25 ... +60 °C
Mechanical service life (switching cycles) typical	10 000 000
Electrical endurance (switching cycles) at AC-15 at 230 V typical	200 000
Contact reliability	one incorrect switching operation of 100 million switching operations (17 V, 1 mA)
Contact reliability of auxiliary contacts	1 faulty switching per 100 million (17 V, 1 mA)
Insulation voltage with degree of pollution 3 rated value	690 V
Surge voltage resistance rated value	6 kV
Auxiliary circuit	
Number of NC contacts for auxiliary contacts	
• instantaneous contact	0

• lagging switching	0
Number of NO contacts for auxiliary contacts	
• instantaneous contact	2
• leading contact	0
Operating current of auxiliary contacts at AC-12	
• at 24 V	10 A
• at 230 V	10 A
• maximum	10 A
Operating current	
• of auxiliary contacts	
— at AC-14	
— at 125 V	6 A
— at 250 V	6 A
— at AC-15	
— at 24 V	6 A
— at 230 V	6 A
— at 400 V	3 A
• at AC-15 at 690 V rated value	1 A
Operating current	
• of auxiliary contacts at DC-12	
— at 24 V	10 A
— at 110 V	3 A
— at 220 V	1 A
• with 2 current paths in series at DC-12	
— at 24 V rated value	10 A
— at 60 V rated value	10 A
— at 110 V rated value	4 A
— at 220 V rated value	2 A
— at 440 V rated value	1.3 A
— at 600 V rated value	0.65 A
• with 3 current paths in series at DC-12	
— at 24 V rated value	10 A
— at 60 V rated value	10 A
— at 110 V rated value	10 A
— at 220 V rated value	3.6 A
— at 440 V rated value	2.5 A
— at 600 V rated value	1.8 A
Operating current	
• of auxiliary contacts at DC-13	
— at 24 V	6 A
— at 60 V	2 A

— at 110 V	1 A
— at 220 V	0.3 A
• with 2 current paths in series at DC-13	
— at 24 V rated value	10 A
— at 60 V rated value	3.5 A
— at 110 V rated value	1.3 A
— at 220 V rated value	0.9 A
— at 440 V rated value	0.2 A
— at 600 V rated value	0.1 A
• with 3 current paths in series at DC-13	
— at 24 V rated value	10 A
— at 60 V rated value	4.7 A
— at 110 V rated value	3 A
— at 220 V rated value	1.2 A
— at 440 V rated value	0.5 A
— at 600 V rated value	0.26 A

Installation/ mounting/ dimensions

Mounting type	snap-on mounting
Width	10 mm
Height	57.4 mm
Depth	66 mm

Connections/Terminals



Type of electrical connection for auxiliary and control current circuit	screw-type terminals
Type of connectable conductor cross-sections	
• for auxiliary contacts	
— finely stranded	
— with core end processing	2x (0.5 ... 1.5 mm ²), 2x (0.75 ... 2.5 mm ²)
• at AWG conductors for auxiliary contacts	2x (20 ... 16), 2x (18 ... 14)



Safety related data

Product function Mirror contact acc. to IEC 60947-4-1	Yes
• Note	with 3RT2
Product function positively driven operation acc. to IEC 60947-5-1	No

Certificates/approvals

General Product Approval				Declaration of Conformity	Test Certificates
 CCC	 CSA	 UL		 EG-Konf.	Special Test Certificate

Test Certificates	Shipping Approval				
Type Test Certificates/Test Report	 ABS	 BUREAU VERITAS	 GL	 LRS	 PRS

Shipping Approval	other		
 RINA	 RMRS	Environmental Confirmations	Confirmation  VDE

Further information

Information- and Downloadcenter (Catalogs, Brochures,...)

<http://www.siemens.com/industrial-controls/catalogs>

Industry Mall (Online ordering system)

<https://mall.industry.siemens.com/mall/en/en/Catalog/product?mlfb=3RH2911-1DA20>

Cax online generator

<http://support.automation.siemens.com/WW/CAXorder/default.aspx?lang=en&mlfb=3RH2911-1DA20>

Service&Support (Manuals, Certificates, Characteristics, FAQs,...)

<https://support.industry.siemens.com/cs/ww/en/ps/3RH2911-1DA20>

Image database (product images, 2D dimension drawings, 3D models, device circuit diagrams, EPLAN macros, ...)

http://www.automation.siemens.com/bilddb/cax_de.aspx?mlfb=3RH2911-1DA20&lang=en

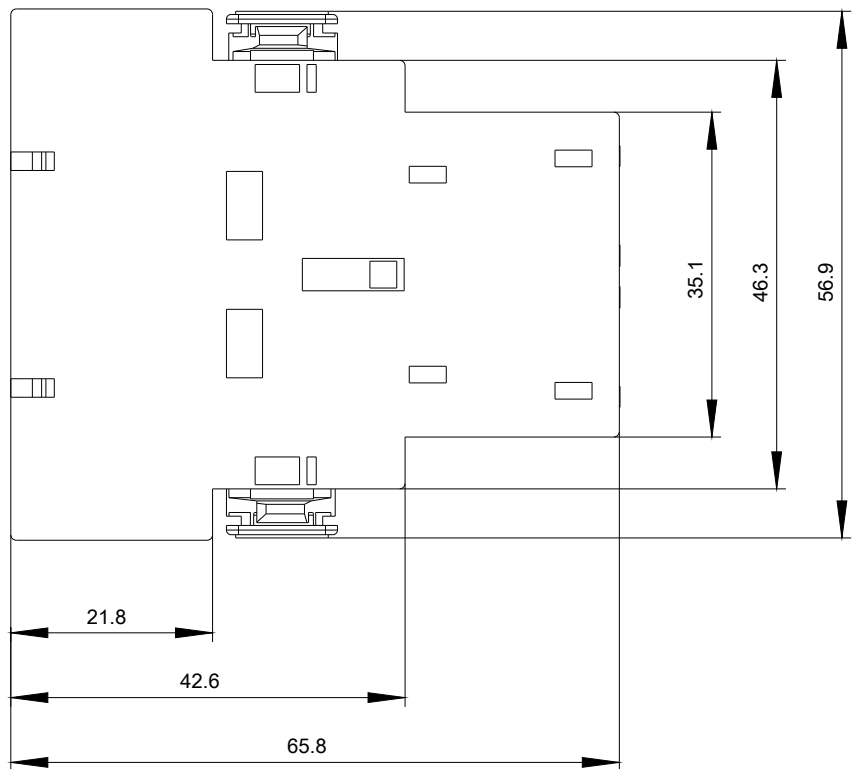
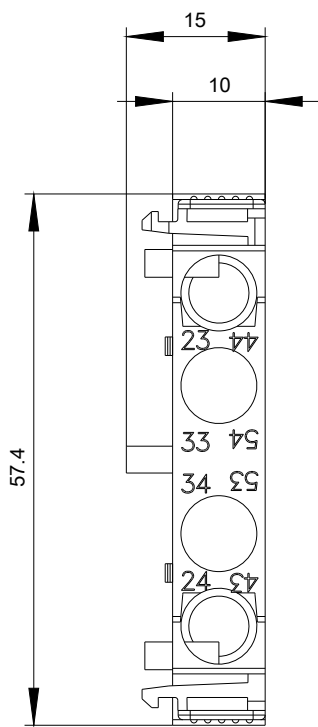



last modified:

06/20/2017