



LV HRC FUSE LINK GL/GG WITH NON-INSULATED GRIP LUGS WITH COMBINATION INDICATOR SIZE 1, 250A, AC 500V/DC 440V

Similar to image

Technical data:

Current / for AC / rated value	A	250
Operating class of the fuse link		gG
Size of the fallback-system / acc. to DIN EN 60269-1		NH1
Supply voltage		
• for AC / rated value	V	500
• for DC	V	440
Switching capacity current		
• in accordance with IEC 60947-2 / rated value	kA	120
• with DC / in accordance with IEC 60947-2 / rated value	kA	25
Design of an identification indicator		Combination alarms
type of the assembly		Non-insulated grip lugs
Protection class IP		IP20, with connected conductors
Climatic class		-20 to +50 at 95% relative humidity
Ambient temperature		
• minimum	°C	-5
• maximum	°C	40
Product description		Using screw adapter or adapter sleeves

Certificates/approvals:

General Product Approval

CSA



GOST



KEMA



VDE

Declaration of Conformity

EG-Konf.

Test Certificates[Special Test Certificate](#)[Type Test Certificates/Test Report](#)**Shipping Approval**

GL

Further information:**Information- and Downloadcenter (Catalogs, Brochures,...)**<http://www.siemens.com/lowvoltage/catalogs>**Industry Mall (Online ordering system)**<http://www.siemens.com/lowvoltage/mall>**Service&Support (Manuals, Certificates, Characteristics, FAQs,...)**<http://support.automation.siemens.com/WW/view/en/3NA7144/all>**Image database (product images, 2D dimension drawings, 3D models, device circuit diagrams, ...)**http://www.automation.siemens.com/bilddb/cax_en.aspx?mlfb=3NA7144**CAX-Online-Generator**<http://www.siemens.com/cax>**Tender specifications**[Datanorm](#) [GAEB81](#) [GAEB83](#) [RTF](#) [TXT](#)

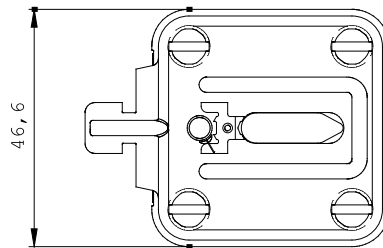
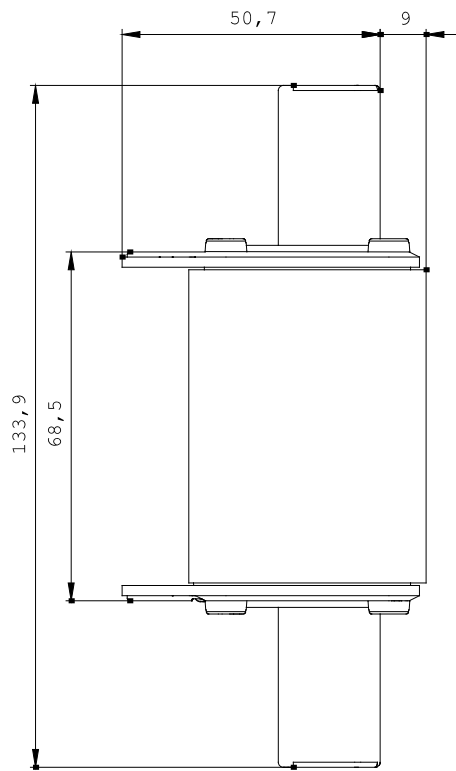

last change:

Mar 18, 2013