

DALI Repeater

Datasheet

Amplifier

Device to enhance the maximum
DALI cable length

Art. Nr. 86458401

Art. Nr. 86458401-PS



DALI Repeater Amplifier

Overview

- Device to enhance the maximum DALI cable length from 300m up to 600m.
- Enhancement and Transmission of the DALI-signals (bidirectional).
- Galvanic separation between DALI-circuits.
- Either radially arranged network layout or cascaded system mounting operated with single master.
- restricted cascading (Series wiring) of multiple repeaters in multi-master operating mode
- The maximum amount of DALI-devices in the total network is limited to 64, the devices can be divided on the sub-circuits at will.
- For each subordinate DALI circuits a separate power supply is needed. (DALI PS)
- Type with integrated power supply available
- Suitable for Din-Rail mounting.

Specification, Characteristics

type	DALI Repeater	DALI Repeater PS
article number	86458401	86458401-PS
power supply	via DALI-line	aus DALI-Bus / 100V-240V AC
typ. current consumption DALI IN	6 mA	2mA
typ. current consumption DALI OUT	4 mA	integrated DALI PS: up to 200mA
Input/output	DALI / DALI	DALI/DALI
mounting	din rail	remote ceiling
geometry	90mm x 58mm x 17mm	120mm x 41mm x 21mm
ambient temperature	-20°C bis +60°C	-20°C bis +60°C
protection class	IP20	IP20

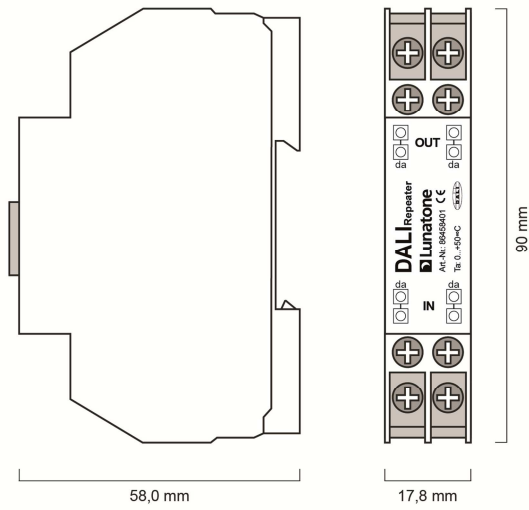

geometry din rail

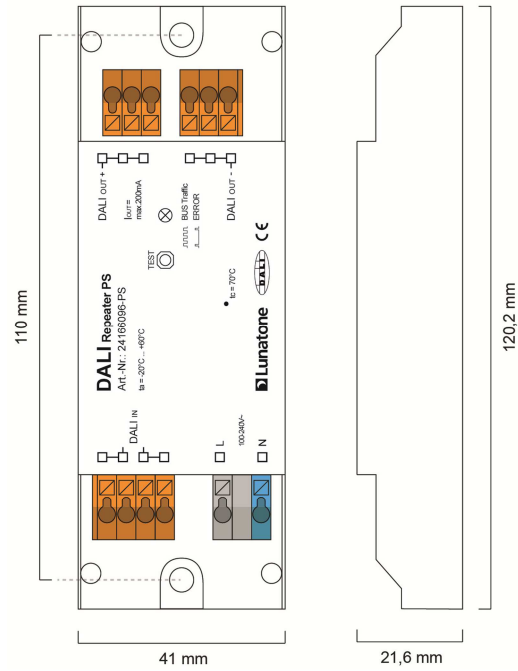

geometry remote ceiling

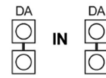
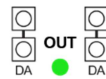

connection plan din rail

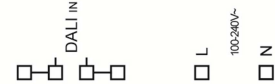
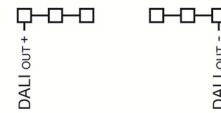

connection plan remote ceiling

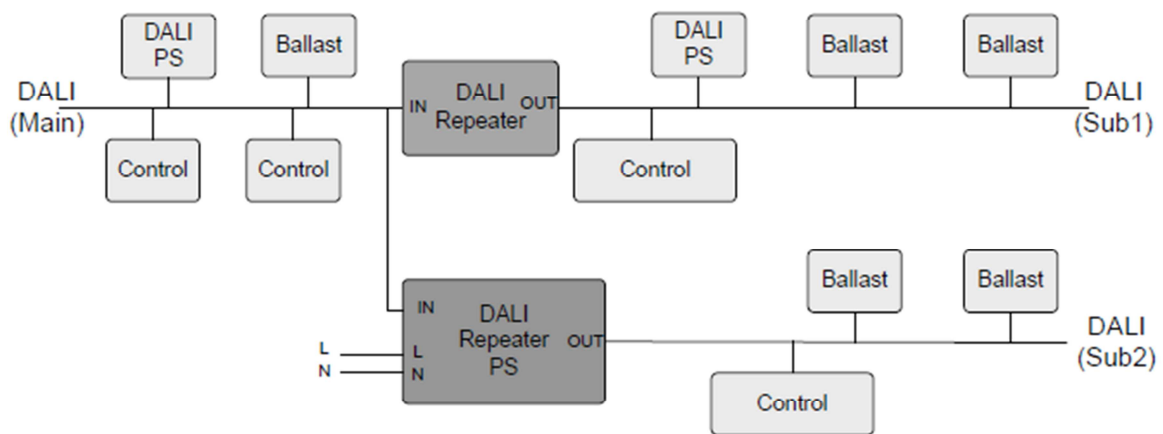

typical application: Dali commands from any control are transmitted in all DALI-lines, on the output of a DALI Repeater with integrated PS no DALI PS is needed

Purchase Information

Art. Nr. 86458401: DALI Repeater, din rail

Art. Nr. 86458401-PS: DALI Repeater,
integrated power supply (200mA), remote
ceiling

Additional Information and Equipment

DALI-Cockpit – free configuration tool from
Lunatone for DALI systems

<http://lunatone.at/en/downloads/Lunatone-DALI-Cockpit.zip>

Lunatone DALI products

<http://www.lunatone.at/en/>

Lunatone datasheets and manuals

<http://lunatone.at/en/downloads/>

Contact

Technical Support: support@lunatone.com

Requests: sales@lunatone.com

www.lunatone.com

Disclaimer

Subject to change. Information provided without guarantee.
The datasheet refers to the current delivery.

The compatibility with other devices must be tested in advance
to the installation.