

## Single Phase Power Supply



### Description

SPMA Modular switching power supplies are specifically designed to satisfy both the industrial automation and the building automation application requirements. The four DIN modules power supplies are capable of up to 100W of output power. Its high efficiency prevents excess of heat in the installation place. These power supplies meet CE, UL508 listed, UL 62368, UL1310 Class 2 (Output), UL 121201 Class1 Div 2, and the 4kVAC isolation voltage that is mandatory for automotive battery charger applications.

### Applications

The SPMA is extremely suitable for automotive battery chargers, high efficiency and applications requiring wide operating ambient temperature. Suitable for use in class 1, division 2, groups a, b, c and d hazardous locations, or nonhazardous locations only. This equipment is an open-type device and must be installed in an enclosure such that the equipment is only accessible with the use of a tool.

Warning: Explosion hazard - do not disconnect equipment while the circuit is live or unless the area is known to be free of ignitable concentrations.

### Main functions

- Universal input voltage range: 85 VAC to 264 VAC; 120 VDC to 350 VDC
- Output options of 5 VDC, 12 VDC, 15 VDC or 24 VDC
- From 1 DIN to 4 DIN modules, from 12 W to 100.8 W
- Bi-colour LED for status indication
- Voltage output adjustment
- High efficiency up to 89%
- 4kVAC isolation voltage

### Benefits

- **Universal AC input range.** SPMA series can be powered with AC voltage (85 VAC to 264 VAC) or with DC voltage (120 VDC to 350 VDC).
- **CE and UL approvals.** These power supplies meet CE, UL508, UL 62368, UL 1310 Class 2 (Output), UL 121201 Class 1 Div 2 (hazardous location installations).
- **Isolation class II.** This series has the Isolation Class II and a Primary - Secondary withstand voltage of 4kVAC.
- **Reliable power in very compact dimensions.** SPMA has an ultra-slim body, from 15W in 17.5mm (1 DIN), up to 100W in only 70mm (4 DIN) of space.
- **High efficiency, long life and high reliability.** The SPMA has a very high efficiency of up to 89%.
- **Reliable critical output protections.** Safe operation is guaranteed by the various output protections: Over Current (OVC), Over Voltage (OVP), Short Circuit (SCP).
- **Wide operating ambient temperature.** The operating temperature range is from -30 °C to +70 °C (-22 °F to 158 °F), and a storage temperature range from -40 °C to +85 °C (-40 °F to 185 °F).
- **Conformal coating (option).** SPMA series are available with the protective coating in order to protect its electronic circuits from harsh environments as humidity and contaminants.

## References

### Order code

 SPMA   1

Enter the code entering the corresponding option instead of

Code	Option	Description	Notes
S	-	Switching	Device typology
P	-	Power supply	
M	-	Modular	
A	-	Advanced	
<input type="checkbox"/>	5	5VDC	Rated output voltage
	12	12VDC	
	15	15VDC	
	24	24VDC	
<input type="checkbox"/>	15	15W	Rated output power
	30	30W	
	60	60W	
	100	100W	
1	-	Single phase input	Input type
<input type="checkbox"/>	-	Class 2	Applies to SPMA241001 models only
	S	Non Class 2	
<input type="checkbox"/>	-		PCB coating
	SCC	Conformal coating version	

### Selection guide

Output Voltage	SPMA...151	SPMA...301	SPMA...601	SPMA...1001	
5 VDC	SPMA05151	SPMA05301	-	-	
12 VDC	SPMA12151	SPMA12301	SPMA12601	SPMA121001	
15 VDC	SPMA15151	SPMA15301	SPMA15601	SPMA151001	
24 VDC	SPMA24151	SPMA24301	SPMA24601	SPMA241001	SPMA241001S

### Further reading

Information	Where to find it	QR
SPMA Installation sheet	<a href="http://cga.pub/?52e71a">http://cga.pub/?52e71a</a>	

## Structure

SPMA...151

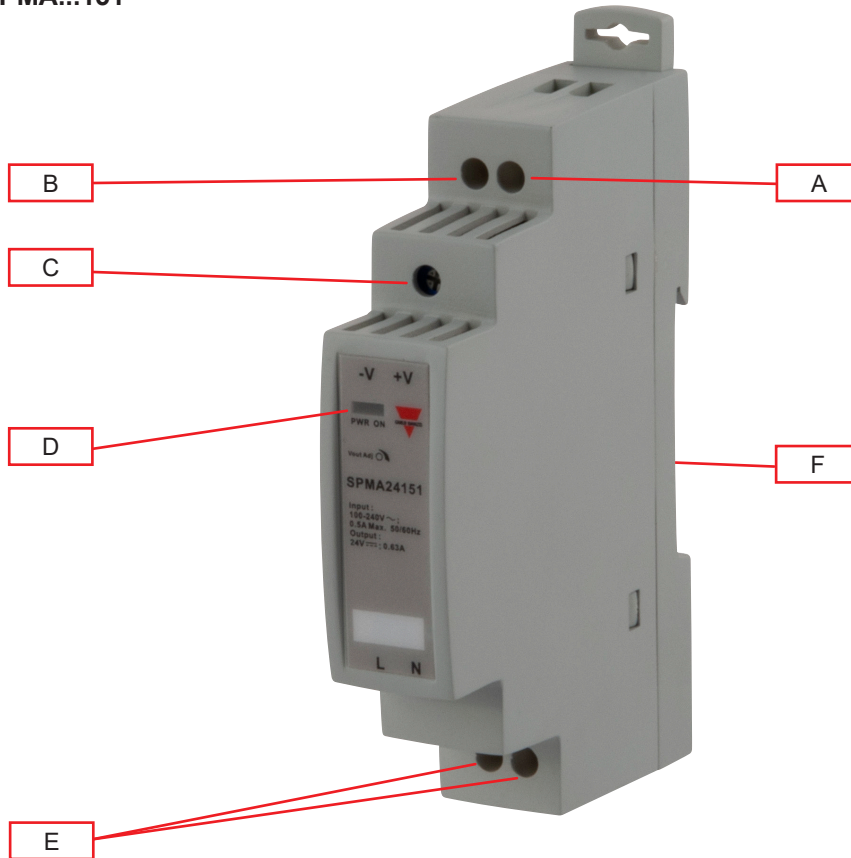

Element	Component	Function
A	+ V terminals	Positive DC output terminals
B	- V terminals	Negative DC output terminals
C	VADJ Trimmer	Output voltage adjustment
D	DC OK LED	Green: output voltage $\geq 90\%$ of rated output voltage Red: output voltage $\leq 80\%$ of rated output voltage or overload
E	Power supply terminals	L, N supply terminals + GND
F	DIN rail mounting clip	Clip present on back side

## SPMA...301 / SPMA...601

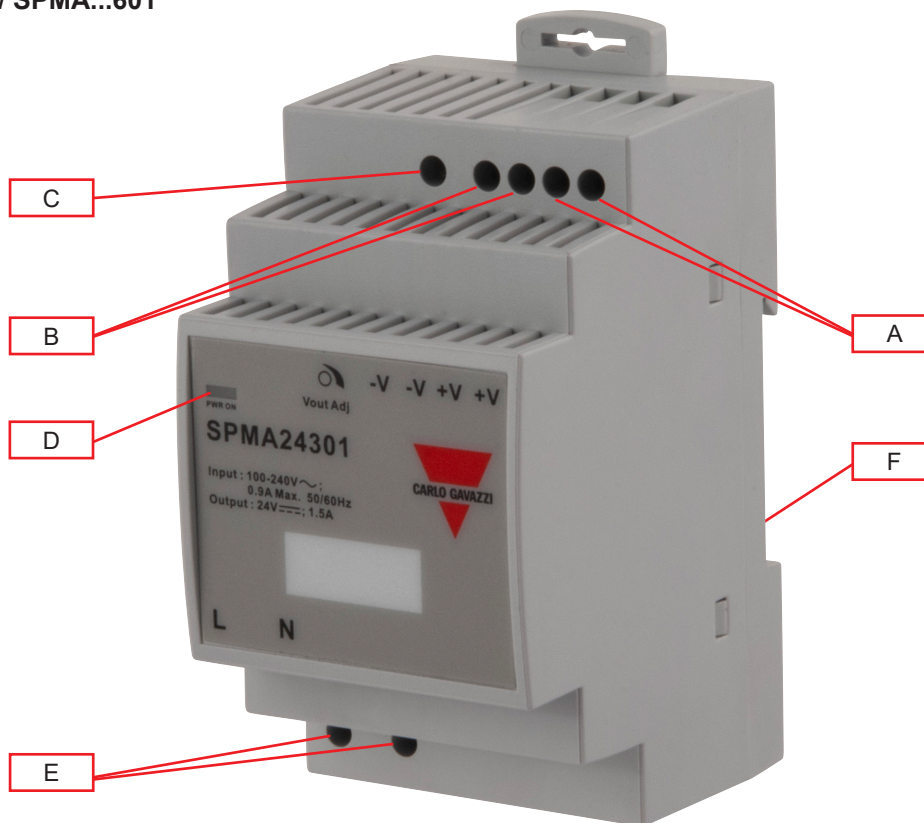

Element	Component	Function
A	+ V terminals	Positive DC output terminals
B	- V terminals	Negative DC output terminals
C	VADJ Trimmer	Output voltage adjustment
D	DC OK LED	Green: output voltage $\geq$ 90% of rated output voltage Red: output voltage $\leq$ 80% of rated output voltage or overload
E	Power supply terminals	L, N supply terminals + GND
F	DIN rail mounting clip	Clip present on back side

# SPMA



## SPMA...1001

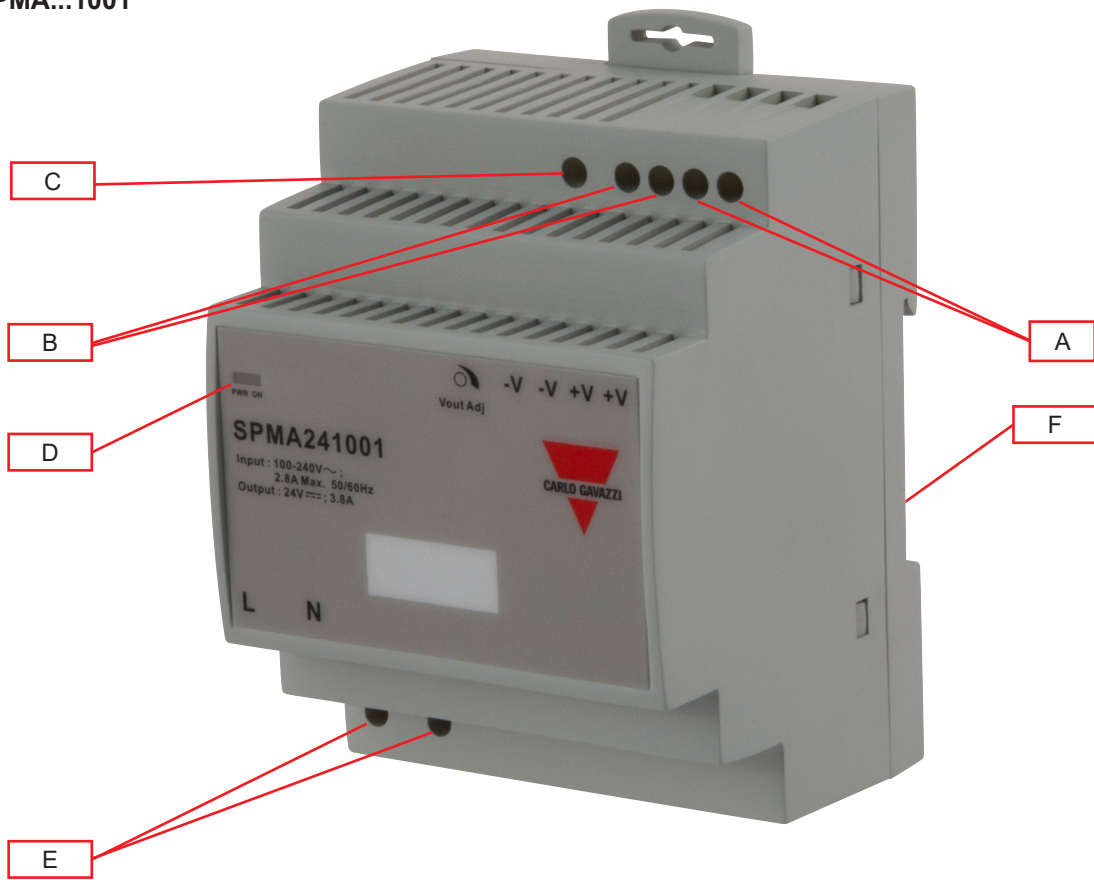

Element	Component	Function
A	+ V terminals	Positive DC output terminals
B	- V terminals	Negative DC output terminals
C	VADJ Trimmer	Output voltage adjustment
D	DC OK LED	Green: output voltage $\geq 90\%$ of rated output voltage Red: output voltage $\leq 80\%$ of rated output voltage or overload
E	Power supply terminals	L, N supply terminals + GND
F	DIN rail mounting clip	Clip present on back side

## Features

### ▶ General data

		SPMA...151	SPMA...301	SPMA...601	SPMA...1001
Leakage current (Input @240VAC, 63Hz)		< 0.25 mA (input - output)			
Efficiency	5 V	77.5 %	81 %	-	-
	12 V	83 %	86 %	86.5 %	87 %
	15 V	84 %	86.5 %	87 %	88 %
	24 V	85 %	88 %	89 %	89 %
Power loss @ nominal load		< 0.5 W			
Ingress protection		IP 20			
MTBF		>300,000 Hrs			
Case material		Plastic			
Weight		71 g	201 g		267 g
Mounting		DIN rail			

(All specifications are at nominal values, full load, 25°C unless otherwise stated)

## Dimensions

### SPMA...151

Unit: mm [inches]

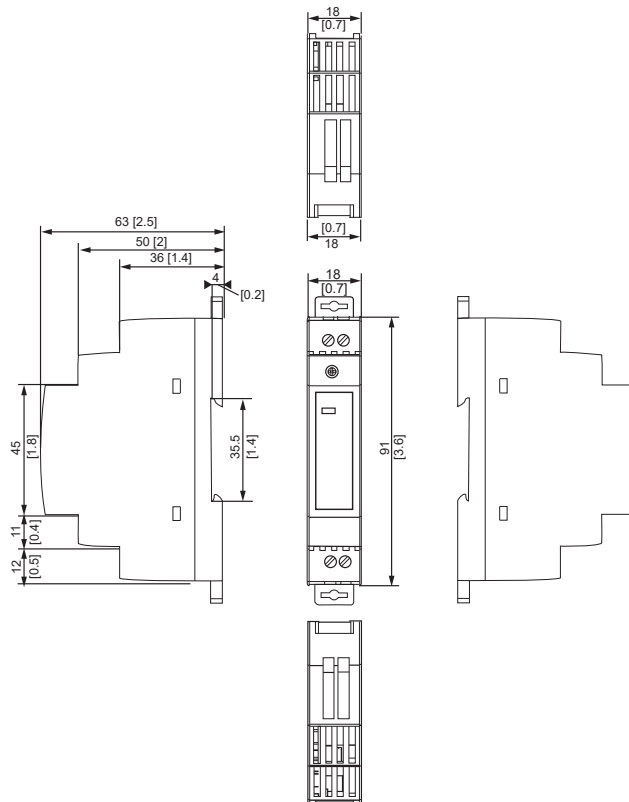

### SPMA...301 / SPMA...601

Unit: mm [inches]

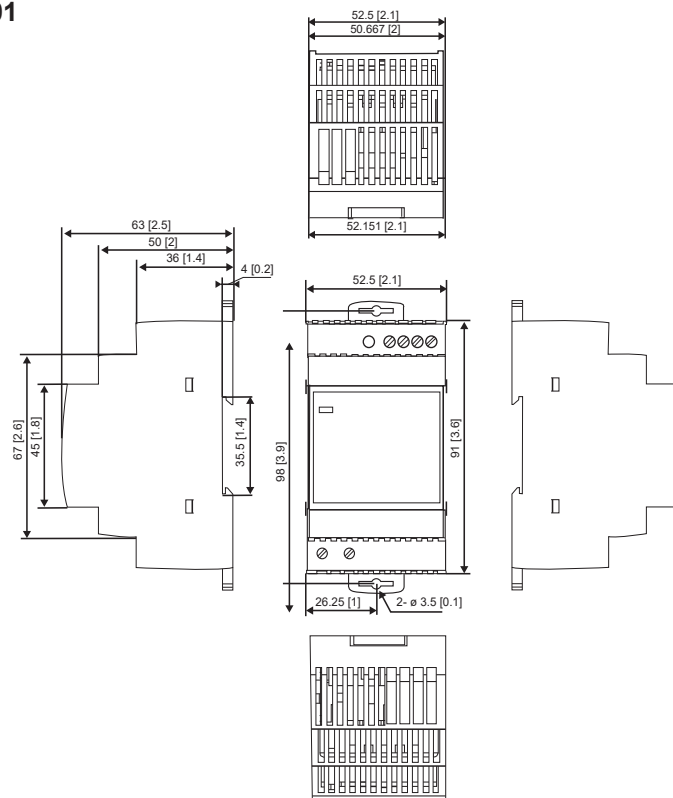

# SPMA



## SPMA...1001

Unit: mm [inches]

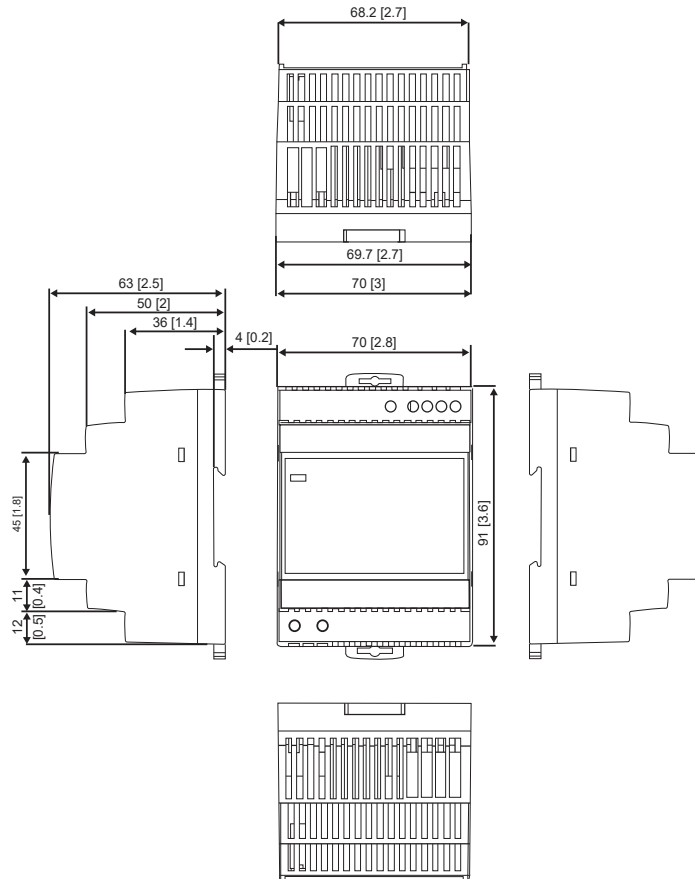

## Connection diagram

### Terminal markings

#### SPMA...151

Terminal	Designation	Description
1	N	Input terminals (neutral conductor, no polarity with DC input)
2	L	Input terminals (phase conductor, no polarity with DC input)
3	V+	Positive output terminal
4	V-	Negative output terminal
5	Vout ADJ.	Potentiometer for output voltage adjustment
6	DC status	LED indication of power supply output status

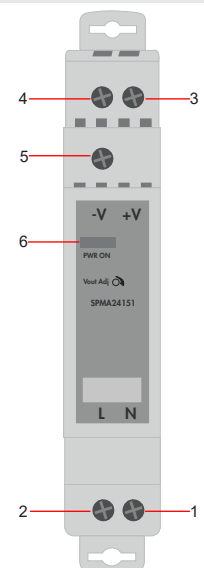



# SPMA



## SPMA...301 / SPMA...601

Terminal	Designation	Description
1	N	Input terminals (neutral conductor, no polarity with DC input)
2	L	Input terminals (phase conductor, no polarity with DC input)
3, 4	V+	Positive output terminal
5, 6	V-	Negative output terminal
7	Vout ADJ.	Potentiometer for output voltage adjustment
8	DC status	LED indication of power supply output status

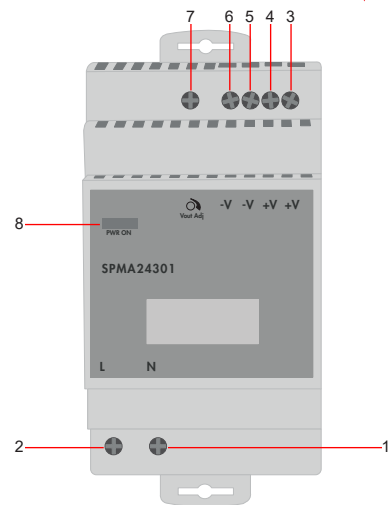

## SPMA...1001

Terminal	Designation	Description
1	N	Input terminals (neutral conductor, no polarity with DC input)
2	L	Input terminals (phase conductor, no polarity with DC input)
3, 4	V+	Positive output terminal
5, 6	V-	Negative output terminal
7	Vout ADJ.	Potentiometer for output voltage adjustment
8	DC status	LED indication of power supply output status

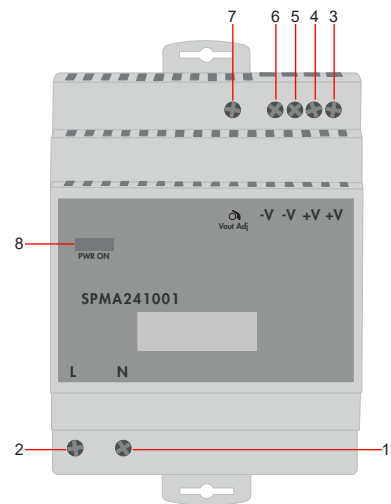

## Environmental

	SPMA...151	SPMA...301	SPMA...601	SPMA...1001
Temperature operating range	-30 °C to 70 °C ( -22 °F to 158 °F)			
Temperature storage	-40 °C to 85 °C ( -40 °F to 185 °F)			
Humidity	10 % to 95 % RH non-condensing			
Temperature derating	Refer to derating diagram			
Temperature regulation	±0.03 % / °C			

## Compatibility and conformity

Safety standards	UL/EN62368-1, UL508
EMC emission	EN55032
Harmonic current	EN61000-3-2, Class A (SPMA...1001S)
EMC immunity	EN55035
CE	EMC 2014/30/EU LVD 2014/35/EU RoHS 2011/65EU + 2015/863
UL certification	UL508 Listed UL62368 UL1310 Class 2 (output)* UL 121201 (Class 1 Div 2)
Vibration resistance	10 ~ 500 Hz, 2G 10 min. / cycle, period for 60 min. each along X, Y, Z axes; Compliance to IEC60068-2-6
Shock resistance	15 G, 11 ms, 3 times along X, Y, Z axes; Compliance to IEC60068-2-27

\* Except for SPMA 05301, SPMA..1001. models

## Insulation

Insulation/Withstand Voltage (I / O)	Primary - Secondary 4.0kVAC / 10 mA
Insulation resistance	100 MΩ
Overvoltage category	II
Pollution degree	2

## Input data

	SPMA...151	SPMA...301	SPMA...601	SPMA...101
Rated input voltage	100 ~ 240 VAC			115 ~ 240 VAC
Input voltage range	85 VAC to 264 VAC 120 VDC to 350 VDC			
AC current (max) 115 VAC 230 VAC	< 0.45 A < 0.25 A	< 0.90 A < 0.5 A	< 1.8 A < 0.9 A	< 2.8 A < 1.4 A
Frequency range	50 Hz to 60 Hz			
Inrush current 115 VAC 230 VAC	< 25 A < 50 A	< 30 A -	- < 60 A	
Internal input fuse (250 VAC)	2 A	3.15 A		5 A
Standby power consumption	< 0.5 W (Subject to load conditions)			

(All specifications are at nominal values, full load, 25°C unless otherwise stated)

## Output data

		SPMA...151	SPMA...301	SPMA...601	SPMA...1001
Output power	5 V	12 W	30 W	-	-
	12 V	15 W	25.2 W	54 W	85.2 W
	15 V		30 W	60 W	91.8 W
	24 V	15.12 W	36 W	60 W	91.92 W   <sup>100.8 W</sup> (100W S)
Voltage accuracy	5 V	± 2.0 %		-	-
	12 V	± 1.0 %			± 2.0 %
	15 V				± 1.0 %
	24 V				± 1.0 %
Line regulation		±0.5 %			
Load regulation		±1.0 %			
Voltage regulation span (VDC)	5 V	5.0 V ~ 5.5 V		-	-
	12 V	10.8 V ~ 13.8 V			12 ~ 13 V
	15 V	13.5 V ~ 18 V			15 ~ 17 V
	24 V	21.6 V ~ 28 V			24 ~ 25.5 V   <sup>21.6 ~ 29 V</sup> (100W S)
Rated output current	5 V	2.4 A	6 A	-	-
	12 V	1.25 A	2.1 A	4.5 A	7.1 A
	15 V	1 A	2 A	4 A	6.1 A
	24 V	0.63 A	1.5 A	2.5 A	3.8 A   <sup>4.2 A</sup> (100W S)
Rated continuous loading	5 V	0 ~ 2.4 A	0 ~ 6.0 A	-	-
	12 V	0 ~ 1.25 A	0 ~ 2.1 A	0 ~ 4.5 A	0 ~ 7.1 A
	15 V	0 ~ 1 A	0 ~ 2 A	0 ~ 2.5 A	0 ~ 6.13 A
	24 V	0 ~ 0.63 A	0 ~ 1.5 A	0 ~ 2.5 A	0 ~ 3.83 A   <sup>0 ~ 4.2 A</sup> (100W S)
Ripple and noise (at 25°C)	5 V	≤ 80 mV	≤ 100 mV		-
	12 V	≤ 120 mV			
	15 V				
	24 V				
Hold up time 115 VAC 230 VAC		≤ 10 ms ≤ 20 ms			
Set-up time 115 VAC 230 VAC		≤ 2000 ms ≤ 1000 ms			
Rise time		≤ 100 ms			
Turn-on overshoot		< 5 %			
Overshoot and undershoot		< 5 %			
Series operation		Yes			
Parallel operation		No			
Power boost		No			

(All specifications are at nominal values, full load, 25°C unless otherwise stated)

## Performance

### Current derating

#### SPMA...151

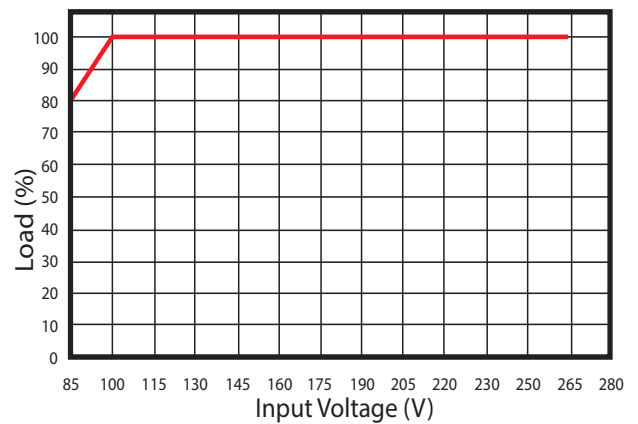
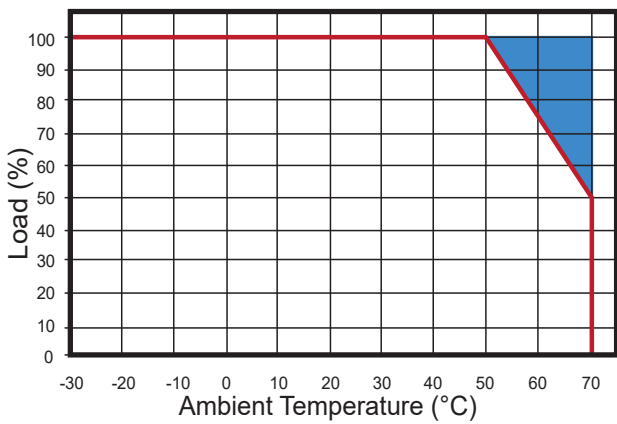

#### SPMA...301

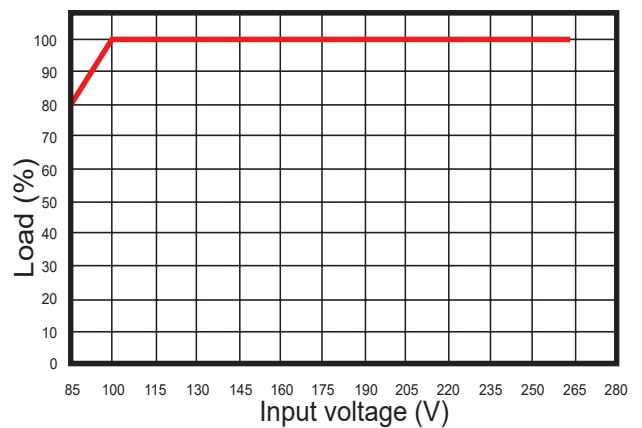
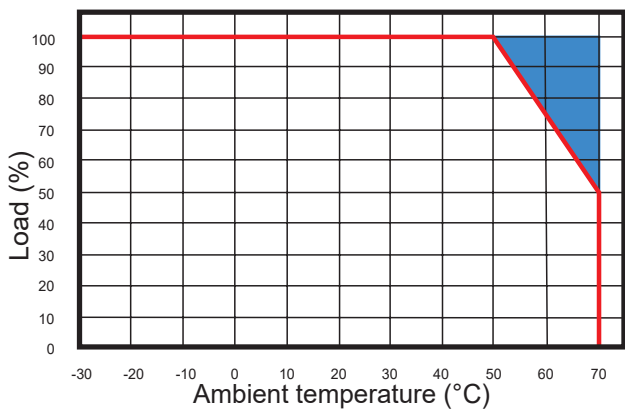

#### SPMA...601

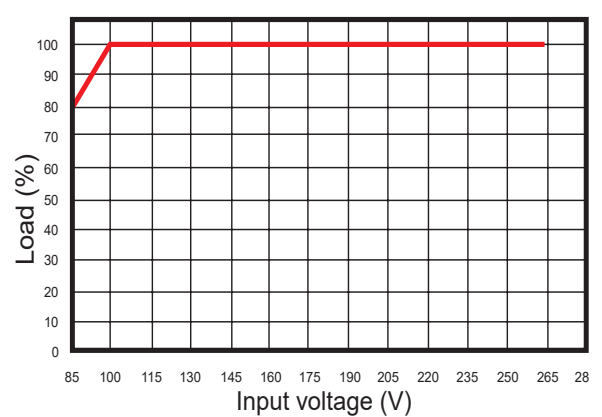
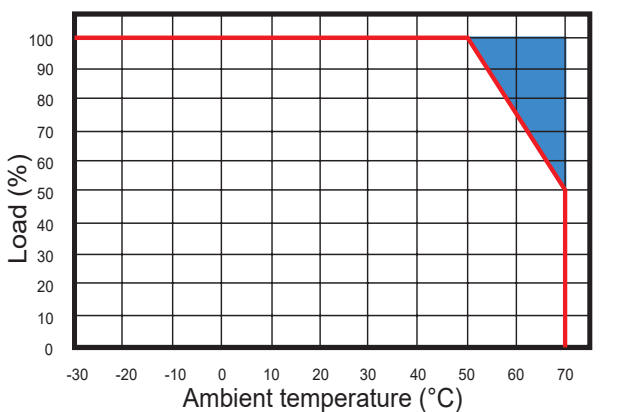

## Current derating

### SPMA...1001

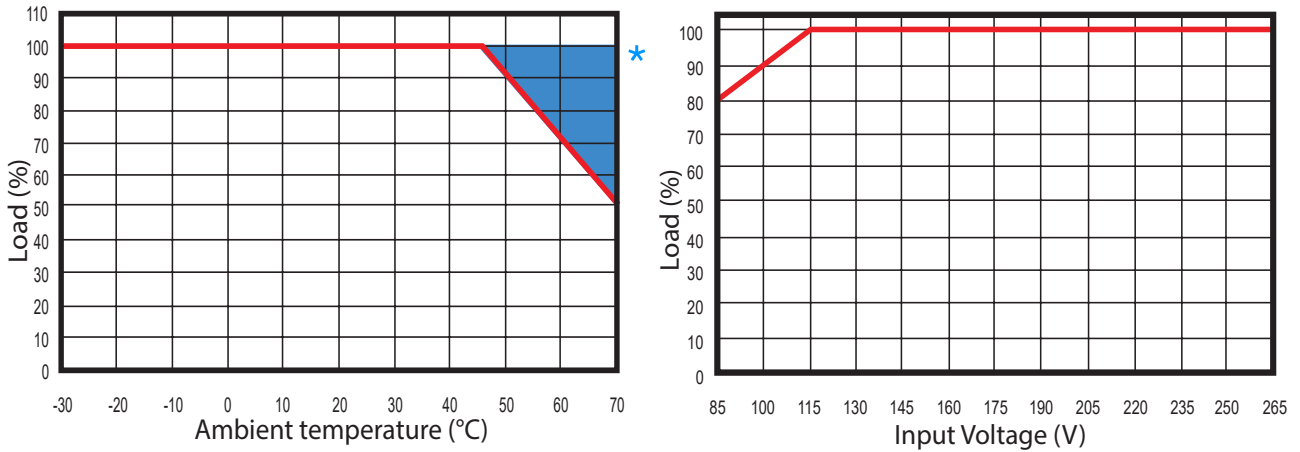

\* Power supply components may degrade, or be damaged, when the power supply is continuously used within the shaded region, refer to the graph.

## Typical current limited curves

### SPMA...151 @ 110 VAC

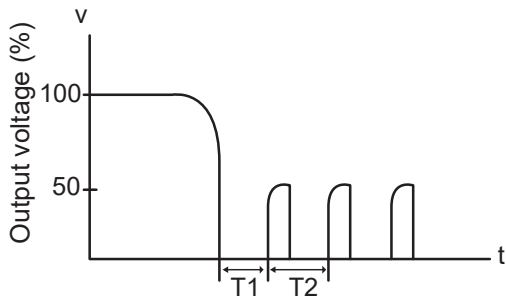

Typ T1: 480 ms, Typ T2: 520 ms

### SPMA...151 @ 230 VAC

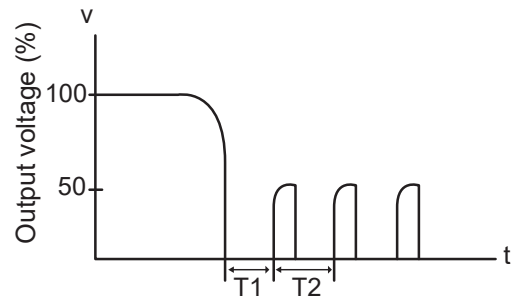

Typ T1: 480 ms, Typ T2: 520 ms

### SPMA...301 / SPMA...601 / SPMA...1001 @ 110 VAC

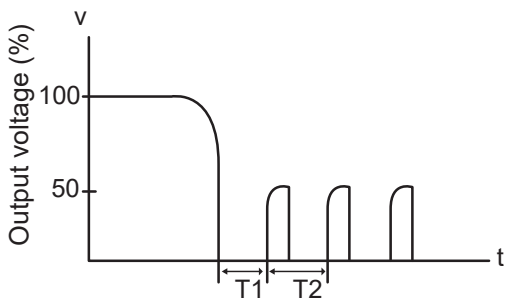

Typ T1: 1100 ms, Typ T2: 1200 ms

### SPMA...301 / SPMA...601 / SPMA...1001 @ 230 VAC

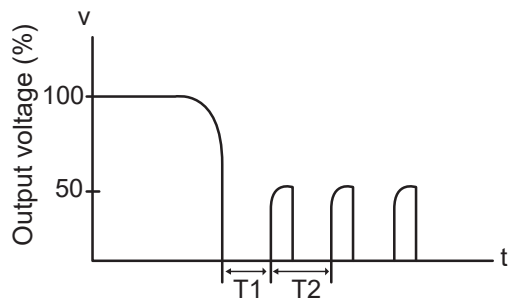

Typ T1: 1100 ms, Typ T2: 1200 ms

## Output characteristics

SPMA...151

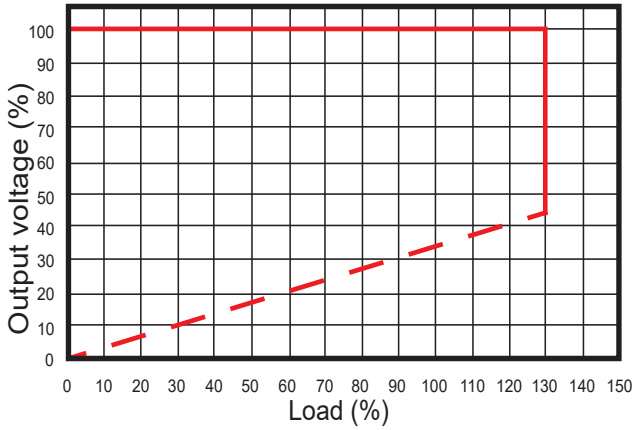

SPMA...301 @ 5 VDC

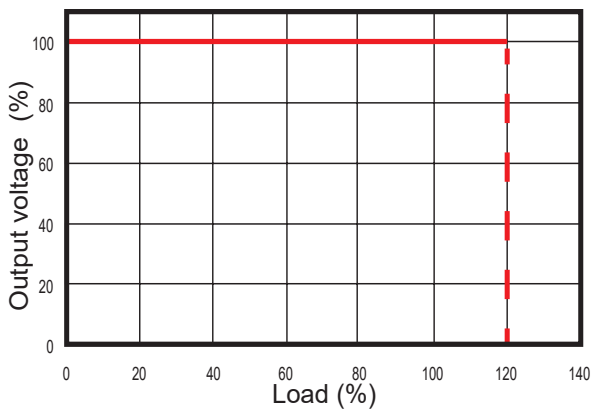

SPMA...301 @ 12 VDC, 15 VDC, 24 VDC

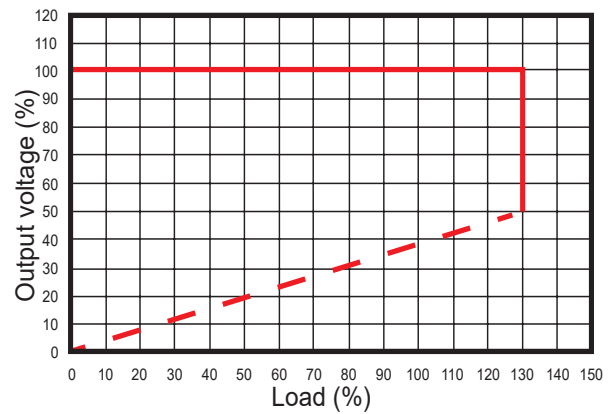

SPMA...601

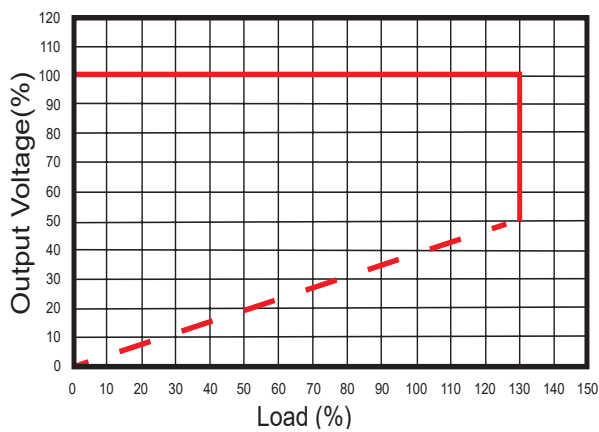

SPMA...1001

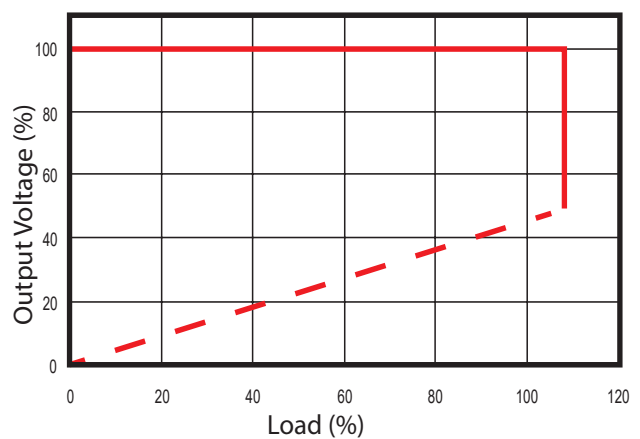

## Typical efficiency curves

### SPMA...151

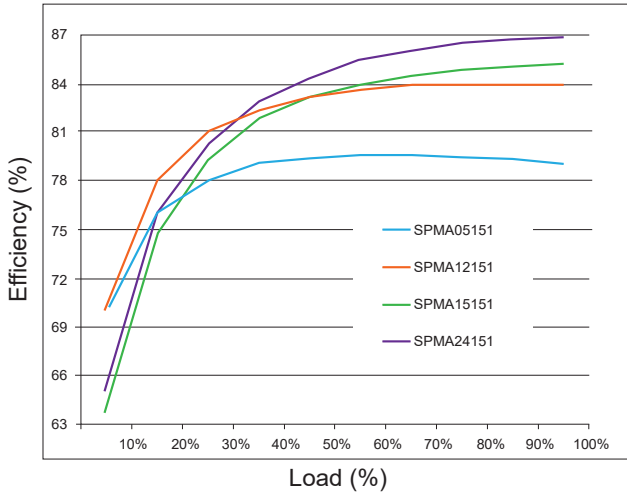

### SPMA...301

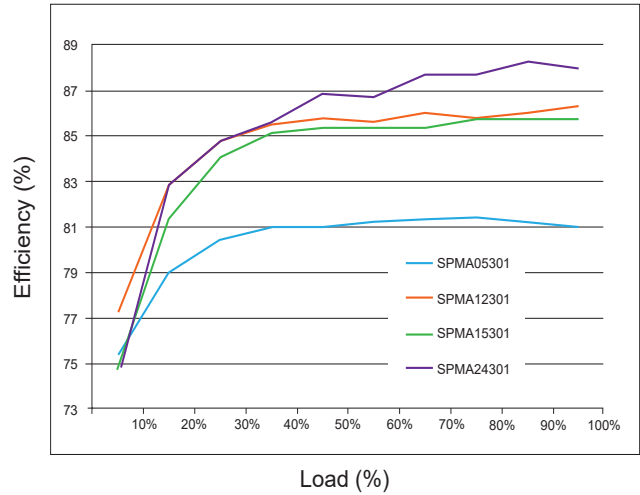

### SPMA...601

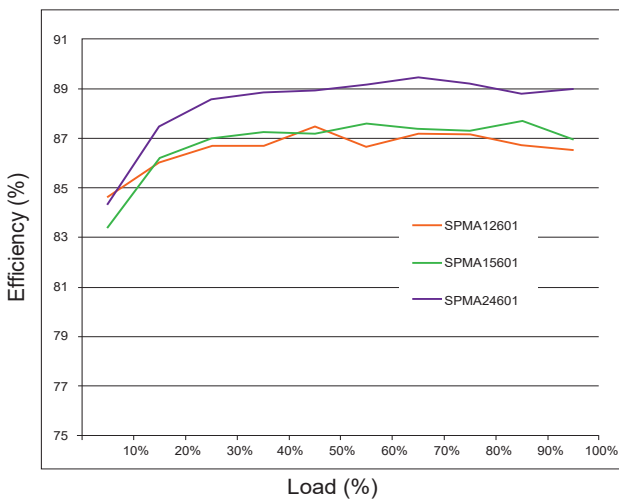

### SPMA...1001

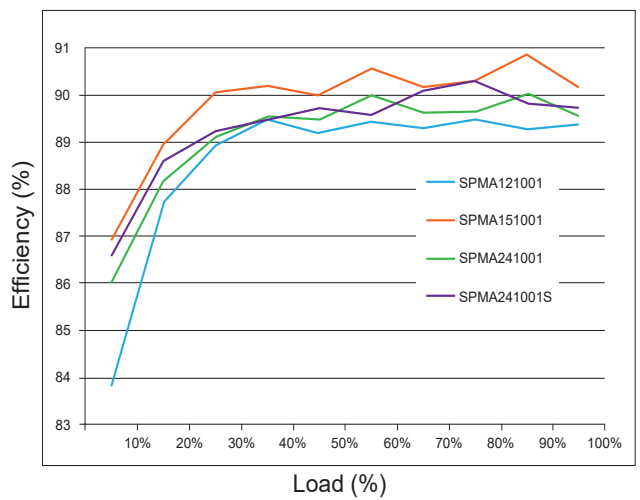

## Installation

Ventilation and cooling	Cooling by free air convection
-------------------------	--------------------------------



## ▶ Wiring diagram

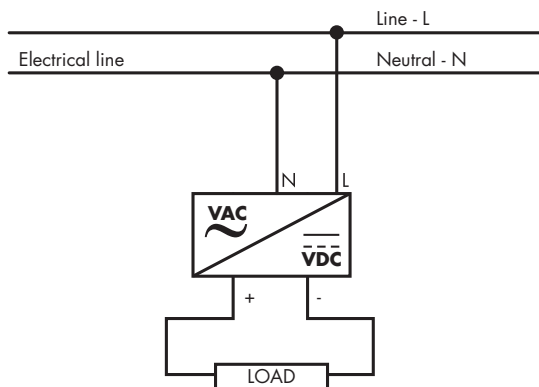

## ▶ Connection specification

		SPMA...151	SPMA...301	SPMA...601	SPMA...1001
Terminal type	Input	screw terminals	screw terminals		
	Output		screw terminals		
Screw driver blade		3.5 mm slotted or Philips			
Tightening torque (recommended)		0.4 Nm			
Flexible conductor cross section max - min		0.5 - 2.5 mm <sup>2</sup>			
Conductor cross section AWG min - max		22 - 12 AWG			
Rigid conductor cross-section min - max		0.5 - 2.5 mm <sup>2</sup>			
Max wire diameter		2.05 mm			

## Block diagram

SPMA...151, SPMA...301, SPMA...601, SPMA...1001

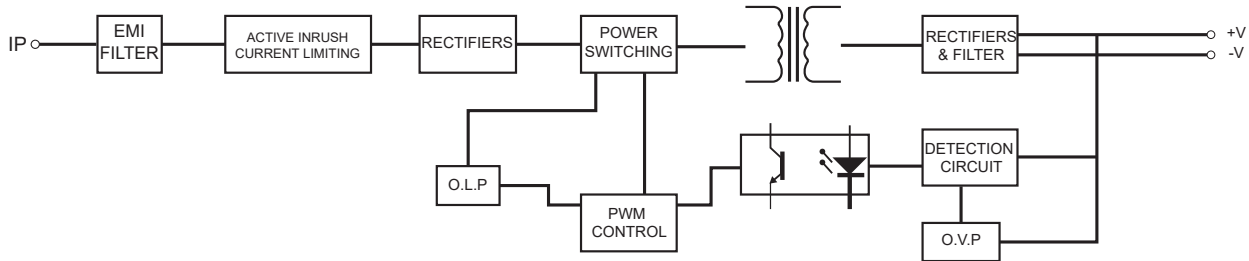

## Troubleshooting

### Signaling and controls

DC OK LED	Yes	
DC OK output type	LED (green)	
DC OK threshold (green colour)	5 V	Output voltage $\geq$ 90% of rated output voltage
	12 V	
	15 V	
	24 V	
Alarm threshold (red colour)	Output voltage $\leq$ 80% of rated output voltage, or overload	

## Operating description

### Control and protection

	SPMA...151	SPMA...301	SPMA...601	SPMA...1001	
Overvoltage protection	5 V	5.8 ~ 7.5 V		-	-
	12 V	14.2 ~ 16.5 V	15 ~ 18 V	14.5 ~ 17.5 V	14.2 ~ 16.2 V
	15 V	18 ~ 20 V	18.8 ~ 22.5 V	18.8 ~ 22.5 V	18.8 ~ 22.5 V
	24 V	29 ~ 33 V	30 ~ 36 V		30 ~ 36 V (100W S)
Overvoltage protection type	Shut off o/p voltage, re-power on				
Overload protection and protection type	110% ~ 150% of rated output current, constant current, auto recovery	110% ~ 150% of rated output current, constant current, auto recovery (12 V / 15 V / 24 V)  110% ~ 150% of rated output current, hiccup mode, auto recovery (5 V)	110% ~ 160% of rated output current, constant current, auto recovery (12 V / 15 V / 24 V)  110% ~ 160% of rated output current, hiccup mode, autor recovery (5 V)	110% ~ 150% (100W S)  102% ~ 110% of rated output current, constant current, auto recovery	
Short circuit protection	Long-term mode, auto recovery				