

Proximity Inductive Sensors Standard Range, Nickel-Plated Brass Housing Types ICB, M30

CARLO GAVAZZI



- Sensing distance: 10 to 15 mm
- Flush or non-flush types
- Short or long body versions
- Rated operational voltage (U_b): 10 - 36 VDC
- Output: DC 200 mA, NPN or PNP
- Normally open or Normally closed
- LED indication for output ON, short-circuit and overload
- Protection: reverse polarity, short circuit, transients
- Cable or M12 plug versions
- According to IEC 60947-5-2
- Laser engraved on front cap, permanently legible
- CSA certified for Hazardous Locations



Product Description

A family of inductive proximity switches in industrial standard nickel-plated brass housings. They are able to handle applications where high sensing range is requested.

Output is open collector NPN or PNP transistors.

Ordering Key

ICB30S30F10NOM1

Type	_____
Housing style	_____
Housing material	_____
Housing size	_____
Housing length	_____
Thread length	_____
Detection principle	_____
Sensing distance	_____
Output type	_____
Output configuration	_____
Connection	_____

Type Selection

Conne- ction	Body style	Rated operating distance S_n	Ordering no. NPN, Normally open	Ordering no. PNP, Normally open	Ordering no. NPN, Normally closed	Ordering no. PNP, Normally closed
Cable	Short	10 mm ¹⁾	ICB30S30F10NO	ICB30S30F10PO	ICB30S30F10NC	ICB30S30F10PC
Cable	Short	15 mm ²⁾	ICB30S30N15NO	ICB30S30N15PO	ICB30S30N15NC	ICB30S30N15PC
Plug	Short	10 mm ¹⁾	ICB30S30F10NOM1	ICB30S30F10POM1	ICB30S30F10NCM1	ICB30S30F10PCM1
Plug	Short	15 mm ²⁾	ICB30S30N15NOM1	ICB30S30N15POM1	ICB30S30N15NCM1	ICB30S30N15PCM1
Cable	Long	10 mm ¹⁾	ICB30L50F10NO	ICB30L50F10PO	ICB30L50F10NC	ICB30L50F10PC
Cable	Long	15 mm ²⁾	ICB30L50N15NO	ICB30L50N15PO	ICB30L50N15NC	ICB30L50N15PC
Plug	Long	10 mm ¹⁾	ICB30L50F10NOM1	ICB30L50F10POM1	ICB30L50F10NCM1	ICB30L50F10PCM1
Plug	Long	15 mm ²⁾	ICB30L50N15NOM1	ICB30L50N15POM1	ICB30L50N15NCM1	ICB30L50N15PCM1

¹⁾ For flush mounting in metal

²⁾ For non-flush mounting in metal

Specifications

Rated operational voltage (U_b)	10 to 36 VDC (ripple incl.)	Indication for output ON	Activated LED, yellow
Ripple	≤ 10%	NO version	Target present
Output current (I_o)	≤ 200 mA @ 50°C (≤ 150 mA @ 50-70°C)	NC version	Target not present
OFF-state current (I_i)	≤ 50 μA	Indication for short circuit/ overload	LED blinking (f = 2 Hz)
No load supply current (I_o)	≤ 15 mA	Assured operating sensing distance (S_a)	$0 \leq S_a \leq 0.81 \times S_n$
Voltage drop (U_d)	Max. 2.5 VDC @ 200 mA	Effective operating distance (S_r)	$0.9 \times S_n \leq S_r \leq 1.1 \times S_n$
Protection	Reverse polarity, short-circuit, transients	Usable operating distance (S_u)	$0.85 \times S_r \leq S_u \leq 1.1 \times S_r$
Voltage transient	1 kV/0.5 J	Repeat accuracy (R)	≤ 5%
Power ON delay (t_v)	300 ms	Differential travel (H)	(Hysteresis)
Operating frequency (f)	≤ 1000 Hz		1 to 20% of sensing dist.

Specifications (cont.)

Ambient temperature	
Operating	
Cable	-25° to +70°C (-13° to +158°F)
Plug	-40° to +70°C (-40° to +158°F)
Storage	-40° to +80°C (-40° to +176°F)
Shock and vibration	IEC 60947-5-2/7.4
Housing material	
Body	Nickel-plated brass
Front cap	Grey thermoplastic polyester
Connection	
Cable	Ø5.2 x 2 m, 3 x 0.34 mm ² , grey PVC, oil proof
Plug	M12 x 1
Degree of protection	IP 67
Weight (cable/nuts included)	
ICB30 S	Max. 185 g
ICB30 L	Max. 195 g
Dimensions	See diagrams below
Tightening torque	25 Nm
Approvals	cULus (UL508)

Approvals (cont.)

cCSAus

Note: The terminal connector (version ...M1) was not evaluated. The suitability of the terminal connector should be determined in the end-use application.

As Process Control Equipment for Hazardous Locations.

- Class I, Division 2, Groups A, B, C and D.
- T5 up to 150 mA, T4A for a load current > 150 mA and up to 200 mA, Enclosure Type 4.

Ambient temperature
Ta: -25° to +60°C.

CCC is not required for products with a maximum operating voltage of ≤ 36 V

EMC protection

IEC 61000-4-2 (ESD)

IEC 61000-4-3
IEC 61000-4-4
IEC 61000-4-6
IEC 61000-4-8

According to IEC 60947-5-2

8 kV air discharge,
4 kV contact discharge
12 V/m
4 kV
10 V
30 A/m

MTTF_d 850 years @ 50°C (122°F)

Dimensions (mm)

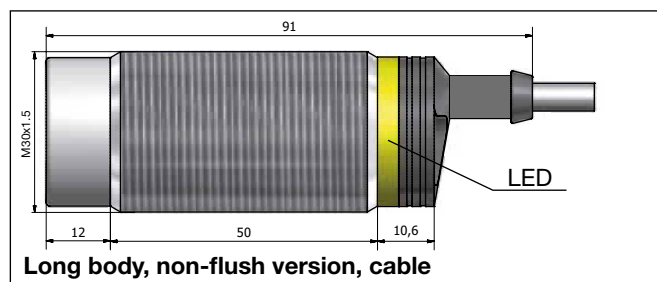
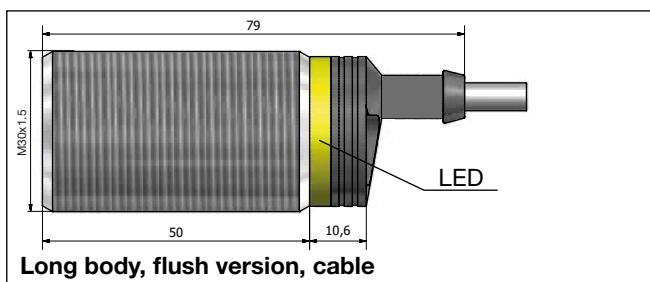
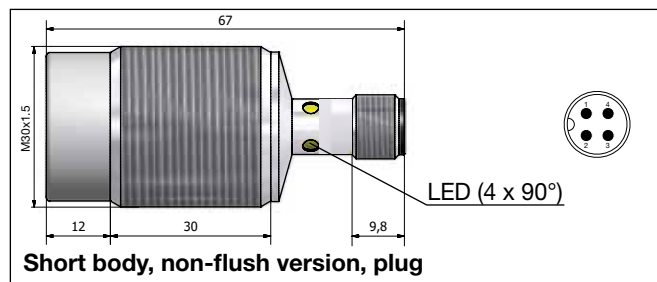
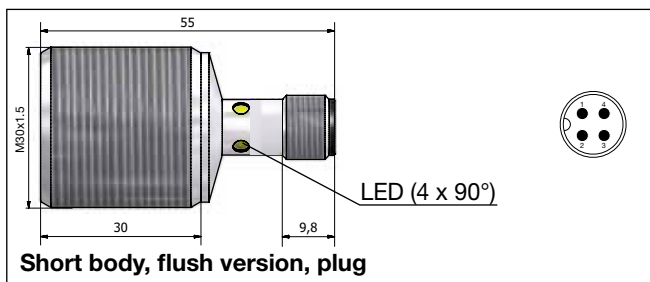
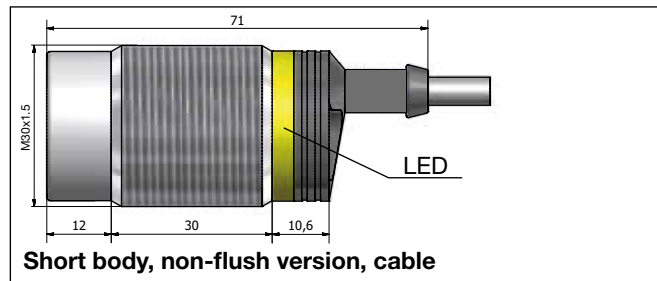
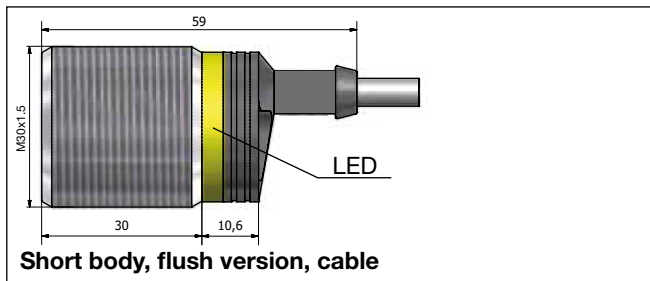

Dimensions (mm) (cont.)

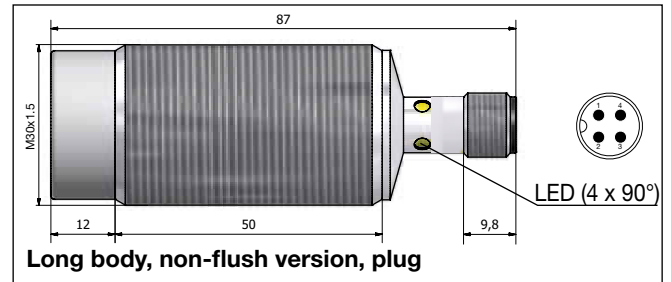
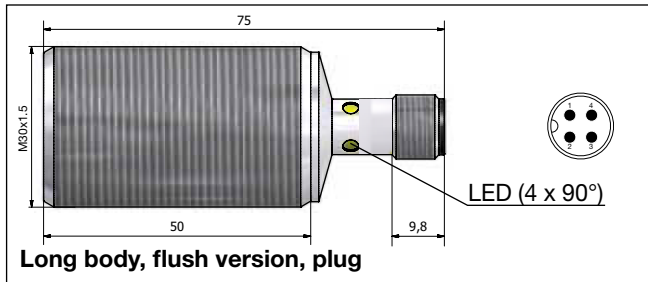

Installation

Flush sensor, when installed in damping material, must be according to Picture 1A.

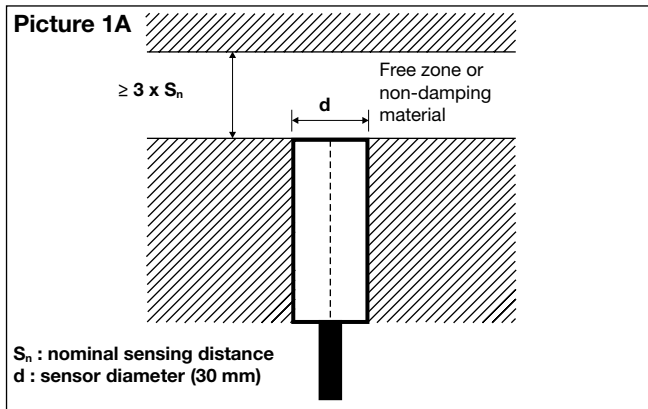

Non-flush sensor, when installed in damping material, must be according to Picture 1B.

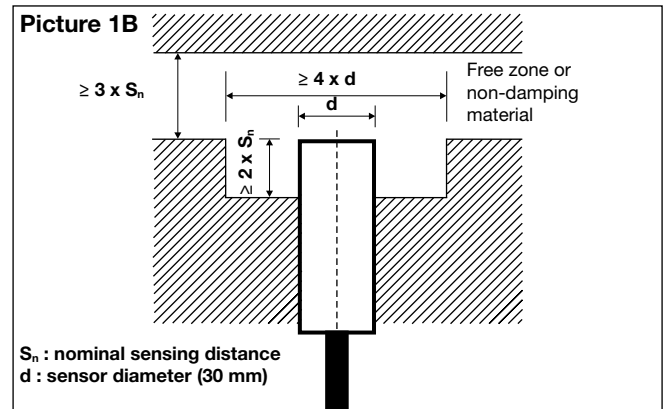

Flush sensors, when installed together in damping material, must be according to Picture 2A.

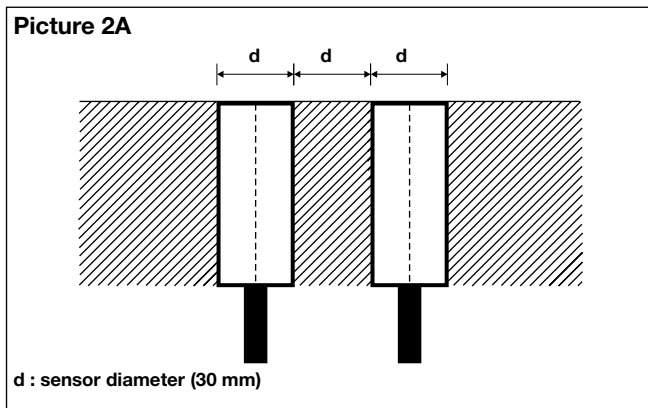

Non-flush sensors, when installed together in damping material, must be according to Picture 2B.

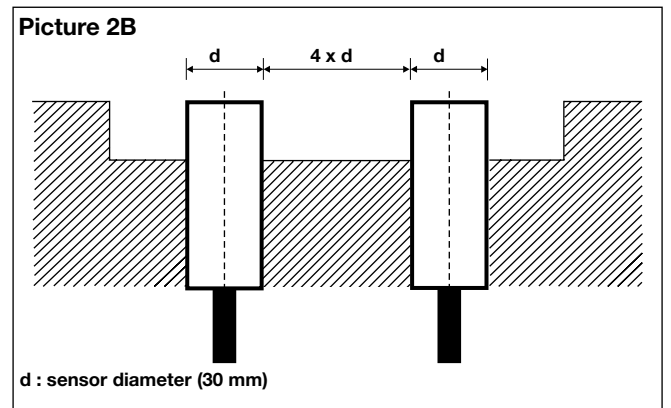

For sensors installed opposite each other, a minimum space of $6 \times S_n$ (the nominal sensing distance) must be observed (See Picture 3).

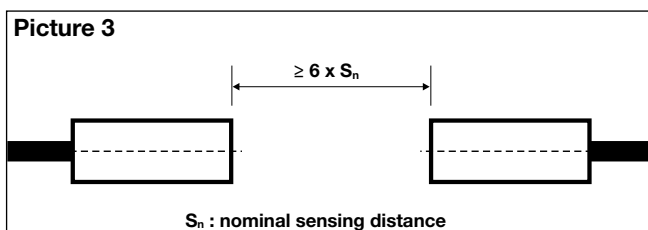



Wiring Diagram

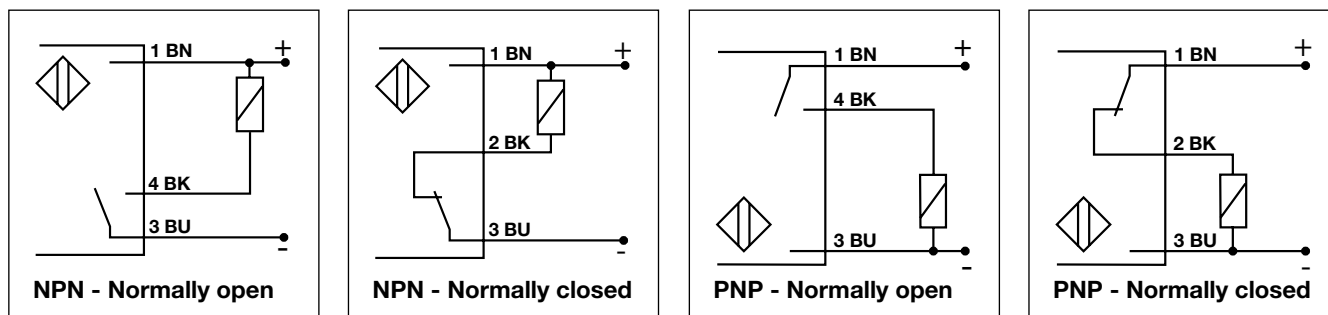

Reduction Factors

The rated operating distance is reduced by the use of metals and alloys other than Fe360.

The most important reduction factors for inductive proximity sensors are shown in Picture 4.

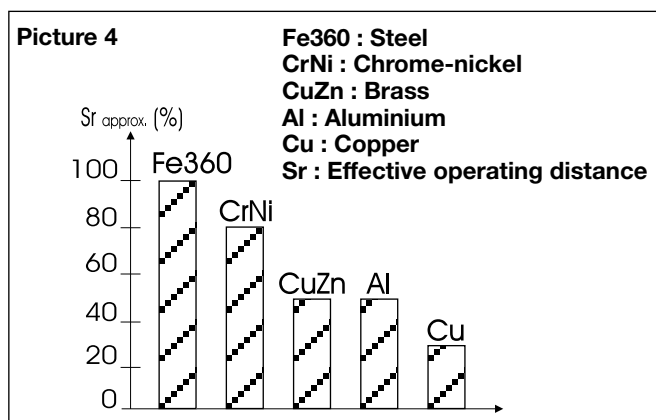

Accessories for Plug Versions

3-wire angled connector, 2 m cable	CONM13NF-A2
3-wire angled connector, 5 m cable	CONM13NF-A5
3-wire angled connector, 10 m cable	CONM13NF-A10
3-wire straight connector, 2 m cable	CONM13NF-S2
3-wire straight connector, 5 m cable	CONM13NF-S5

For any additional information or different options, please refer to the "General Accessories" datasheets.

Delivery Contents

- Inductive proximity switch ICB.
- 2 nuts NPB
- Packaging: plastic bag