

DPB52



True RMS 3-Phase, Multifunction monitoring relay



Benefits

- **Measuring Voltage Range.** Very wide input voltage range: from 125 to 624V (208V – 40% to 480 + 30%).
- **Adjustable Voltage Ranges and over / under.** 7 Voltage ranges can be selected by means of a front dial. Over and under voltages are adjustable from + or - 2 to 22% of the selected range.
- **Bicolour Alarm LED indication.** A green/red LED provides visual indication of the alarms status by means of colours of blinks.
- **Output LED indication.** A yellow LED provides visual indication of the output status.
- **Relay contact output.** TA relay contact provides electrical (remote) indication of the alarms/output status.
- **High Compactness.** The DPA52 is a 3-Phase monitoring relay with 17,5mm width.

Description

DPB52 is a monitoring relay suitable 3-phase without neutral mains. Further to protect loads from wrong phase sequence and phase loss, it also provides the undervoltage and overvoltage features with adjustable delay ON. The phase loss is detected also with regenerated voltage presence.

DPB52 the device supply is provided by the measured mains. Being switch mode, the power supply, besides immune to disturbances, transients and harmonics problems, is also wide range input. Further protection, against humidity and dust, is provided by the conformal coating of the internal circuitry.

The output signal is provided by a 5A changeover electromechanical relay.

2 front LEDs provide visual indication of output state and alarm discrimination. Alarm LED is bi-colour, its colour and flashes indicate the operation status.

Due to the low profile DIN construction it is possible to install it either in industrial cabinets as well as the electrical distribution NORM panels.

Applications

DPB52 is suitable for all applications where it is necessary to monitor besides the phase presence and correct phase sequence of three-phase load mains, also the correct value: lifts, escalators, HVAC, material handling, pumps and compressors, machines for export markets.

DPB52



Main function

- 3Ph monitoring
- From 208V to 480V rated input
- Adjustable Over / Under Voltage and Delay ON
- Phase sequence and Phase loss Alarm
- 5A SPDT relay output
- MiniDIN 17.5 housing

Structure

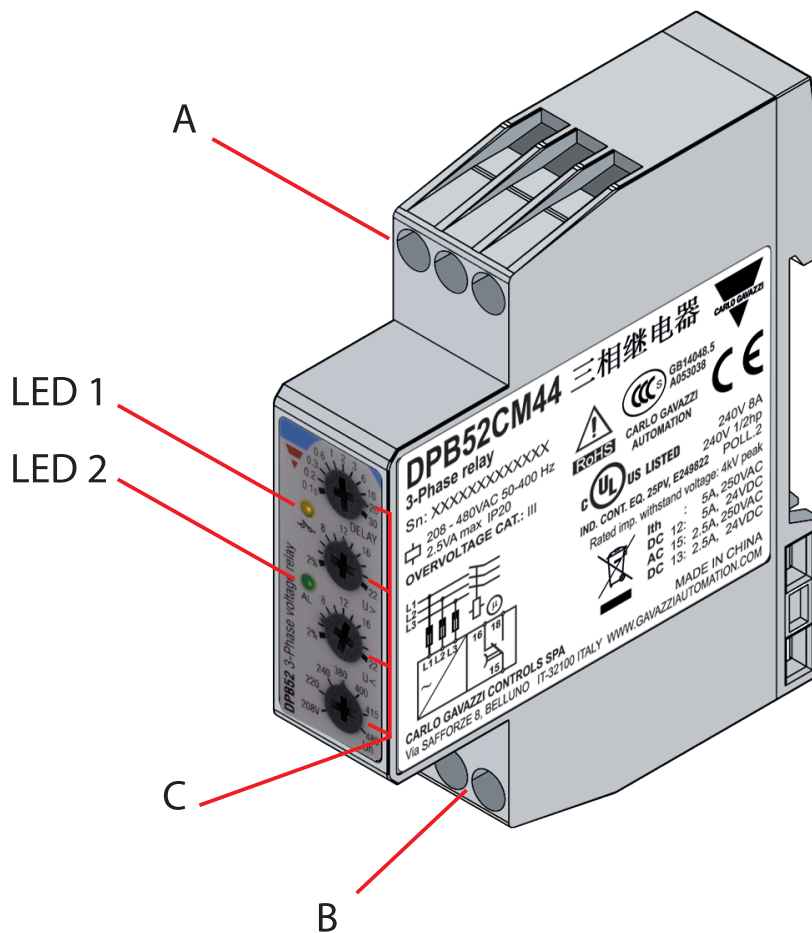

Element	Component	Function
A	Input/supply terminals	L1, L2 and L3 supply and measuring terminals
B	Output terminals	Output Relay contacts terminals: COM, NO and NC
LED 1	Output Led	LED lit when Output is Energised
LED 2	Alarm LED	Bicolour green/red LED, blinking or fixed: Steady ON green: OK (no alarms) Green Flashing: UNDER or OVER triggered, Delay ON is elapsing 1 red flash: out of range parameters alarm 2 red flashes: Wrong phase sequence alarm 3 red flashes: Phase loss Alarm 4 red flashes: Under voltage after Delay ON elapsed 5 red flashes: Over voltage after Delay ON elapsed
C	Dials	Settings for Over Voltage, Under Voltage, Delay ON, Rated Line Voltage

DPB52



Features

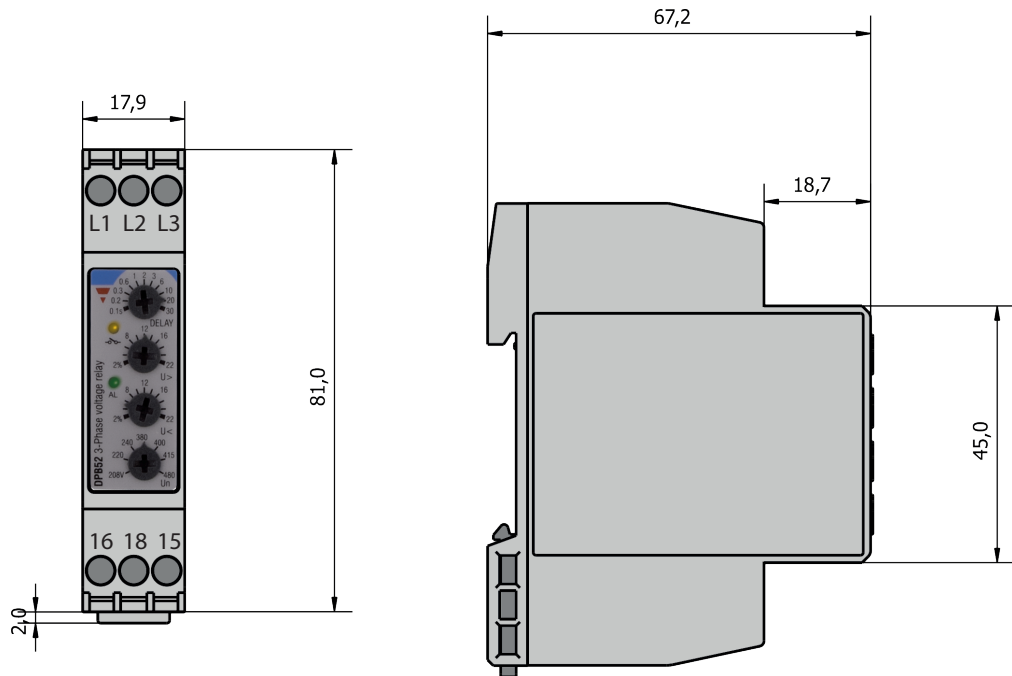

General data

Material	Nylon
Protection grade	IP20
Housing colour	RAL7035
Weight	approx. 75g (2.65oz)
Dimensions	81H x 67.2D x 17.5W
Terminals wire size	AWG30 to AWG13, stranded or solid
Terminals tightening torque	max. 0.5Nm

▶ Power supply

Power supply	Voltage range: 208V -40% to 480V +30% (125V to 624V) Supplied from L2, L3 measured phases Frequency range: 45Hz to 65Hz sinusoidal waveform
Consumption	< 2 VA

▶ Environmental

Working temperature	-20° C to 60° C (-4° F to 140° F)
Storage temperature	-30° C to 80° C (-22° F to 176° F)
Relative humidity	5%-95%
Pollution degree	2
Operating max altitude	2000m a.m.s.l. (6562ft)
Salinity	No saline environment
UV resistance	None
Other	Possible UV exposure if installed in an outdoor Electric panel with transparent door



Vibration/Shock resistance	
Tests with the device outside the box:	
Vibration response (IEC60255-21-1)	Class1
Vibration endurance (IEC 60255-21-1)	Class1
Shock (IEC 60255-21-2)	Class1
Bump (IEC 60255-21-2)	Class1
Tests with the device inside the box:	
Vibration, random (IEC60068-2-64)	Class1
Shock (IEC 60255-21-2)	Class1
Bump (IEC 60255-21-2)	Class1

Note:

Class 1: Monitoring devices for normal use in power plants, substations and industrial plants and for normal transportation conditions.

The packaging type is designed and implemented in such manner that the severity class parameters will not be exceeded during transportation.

Compatibility and conformity

Approvals	  
CE Marking	LV directive, EMC directive EN 60947-5-1
cULus Marking	UL 508, CSA 22.2

Inputs

Measuring ranges	
Variable measuring	Voltage PH-PH measurement on L1, L2 and L3 lines Phase sequence Phase loss Out of range measurement

Voltage measurement	
Typology	PH-PH voltage measurement on L1, L2 and L3 lines
Nominal Line Range	From 208Vac -35% to 480Vac +25% (135Vac to 600Vac)
Setting ranges (Un)	208V, 220V, 240V, 380V, 400V, 415V, 480V
Overload range	<125V (208Vac -40%) and >624 (480V+30%)

Over / Under Voltage alarms	
Input variables	Voltage measurement L1L2, L2L3, L1L3
Reaction time	≤ 200ms + set Delay ON
Undervoltage setting range (U<)	from -2% to -22%
Overvoltage setting range (U>)	from 2% to 22%
Resolution	1V + 2% notch
Accuracy	1V + 2%
Repeatability	0.5% reading +1V +/-0.2%
Hysteresis	2% fixed
Delay ON	Adjustable from 0.1s to 30s
Delay OFF	None

Phase Loss alarm	
Input variables	L1-L2, L2-L3 and L3-L1 Voltage measurements
Alarm Threshold	$\leq 75\%$ of $(1 - (L1,2,3 \text{ Max} - L1,2,3\text{Min}) / L1,2,3\text{Avg})$
Restore threshold	$> 75\%$ of $(1 - (L1,2,3 \text{ Max} - L1,2,3\text{Min}) / L1,2,3\text{Avg}) + \text{Hysteresis}$
Adjustable range	Fixed
Reaction time	$\leq 200\text{ms}$
Resolution	1V
Accuracy	1% reading +1V
Repeatability	0.5% reading +1V
Hysteresis	2% fixed
Delay ON	None
Delay OFF	None

Phase Sequence alarm	
Input variables	Connections L1, L2, L3
Restore threshold	$\leq 200\text{ms}$
Adjustable range	Not applicable, always active.
Delay ON	None
Delay OFF	None

Out of range alarm	
Input variables	L1-L2, L2-L3 and L3-L1 Voltage measurements
Reaction time	$\leq 200\text{ms}$
Resolution	1V
Accuracy	1% reading +1V
Repeatability	0.5% reading +1V
Hysteresis	2%
Delay ON	None
Delay OFF	None

Output

Number of outputs	1
Type	SPDT electromechanical relay with change-over contacts
Logic	Output De-Energized on Alarm
Contact rating	AC1: 5A @ 250Vac AC15: 2.5A @ 250Vac DC12: 5A @ 24Vdc DC13: 2.5A @ 24Vdc
Assignment	Associated to all alarm types

Insulation

Terminals	Basic Insulation
Inputs: L1,L2,L3 to Output: 11,12,14	2.5KVrms, 4KV impulse 1.2/50us (basic)

Operating description

- **Suitability**

DPB52 can be used for power supply and mains quality monitoring of three-phase loads with nominal supply voltage from 208VAC to 480VAC. Monitoring function is performed between Line to Line.

- **Device configuration**

The relay operates when all the phases are present, the phase sequence is correct and the phase-phase voltage levels are within set limits. The relay releases when one or more phase-phase voltages exceeds the upper set level or drops below the lower set level.

The DPB52 is configurable by trimmers, in order to set Over / Under Voltage, Delay ON and Rated Line Voltage.

User interface dial for OVERVOLTAGE adjustment	
Typology	Linear selection from +2% to +22%
Resolution	2% / notch
Accuracy	Absolute +/-1% (e.g. trimmer position on notch 10% => set value from 9% to 11%)
Repeatability	Absolute +/-0.2% (e.g. set value 10% => variation from 9.8% to 10.2%)
Function	Relative voltage threshold setting of OVERVOLTAGE alarm

User interface dial for UNDERVOLTAGE adjustment	
Typology	Linear selection from -2% to -22%
Resolution	2% / notch
Accuracy	Absolute +/-1% (e.g. trimmer position on notch 10% => set value from 9% to 11%)
Repeatability	Absolute +/-0.2% (e.g. set value 10% => variation from 9.8% to 10.2%)
Function	Relative voltage threshold setting of UNDERVOLTAGE alarm

User interface dial for DELAY setting	
Typology	Logarithmic adjustment from 0.1s to 30s
Resolution	From 100ms/notch at 0.1s to 10s/notch at 30s
Accuracy	Absolute form +/-50ms at 0.1s to +/-5s at 30s
Repeatability	Absolute form +/-10ms at 0.1s to +/-1 at 30s
Function	Alarm ON Delay setting for undervoltage and overvoltage

User interface dial for NOMINAL grid voltage	
Typology	7 ranges selection 208V, 220V, 240V, 380V, 400V, 415V, 480V
Function	Nominal Mains voltage selection

- **Alarms**

The DPB52 operates in 2 different modes depending upon the alarm type. The following ones cause immediate output relay de-energisation:

- Phase loss
- Wrong phase sequence
- Out of range measurement

The following ones will cause output relay de-energisation after the set Delay on alarm has elapsed.

- Undervoltage U<
- Overvoltage U>

In this case if the alarm cause returns to normal condition, before delay elapsing, the output will not switch.

- **Visual information**

The DPB52 features 2 front LEDs which provide the relay status information

- LED1 (Output Led) is lit when the Output is Energized
- LED2 (Alarm Led) is bicolour green/red and can be blinking or fixed:
 - Green On fixed: OK (NO Alarms)
 - Green Flashing: Undervoltage or Overvoltage alarm triggered but delay still elapsing
 - 1 red flash: Out of range parameters alarm ON
 - 2 red flashes: Phase sequence alarm ON
 - 3 red flashes: Phase loss alarm ON
 - 4 red flashes: Under voltage alarm ON
 - 5 red flashes: Over voltage alarm ON

- **Phase loss**

Phase loss measurement is performed by comparing the 3 phases voltage values (L1-L2, L2-L3, L1-L3). If the voltage of one phase falls below 75% compared to the other 2 phases, the alarm goes off. DPB52 detects loads regenerated voltage, for instance on motor or transformer loads.

DPB52



General operation block diagram

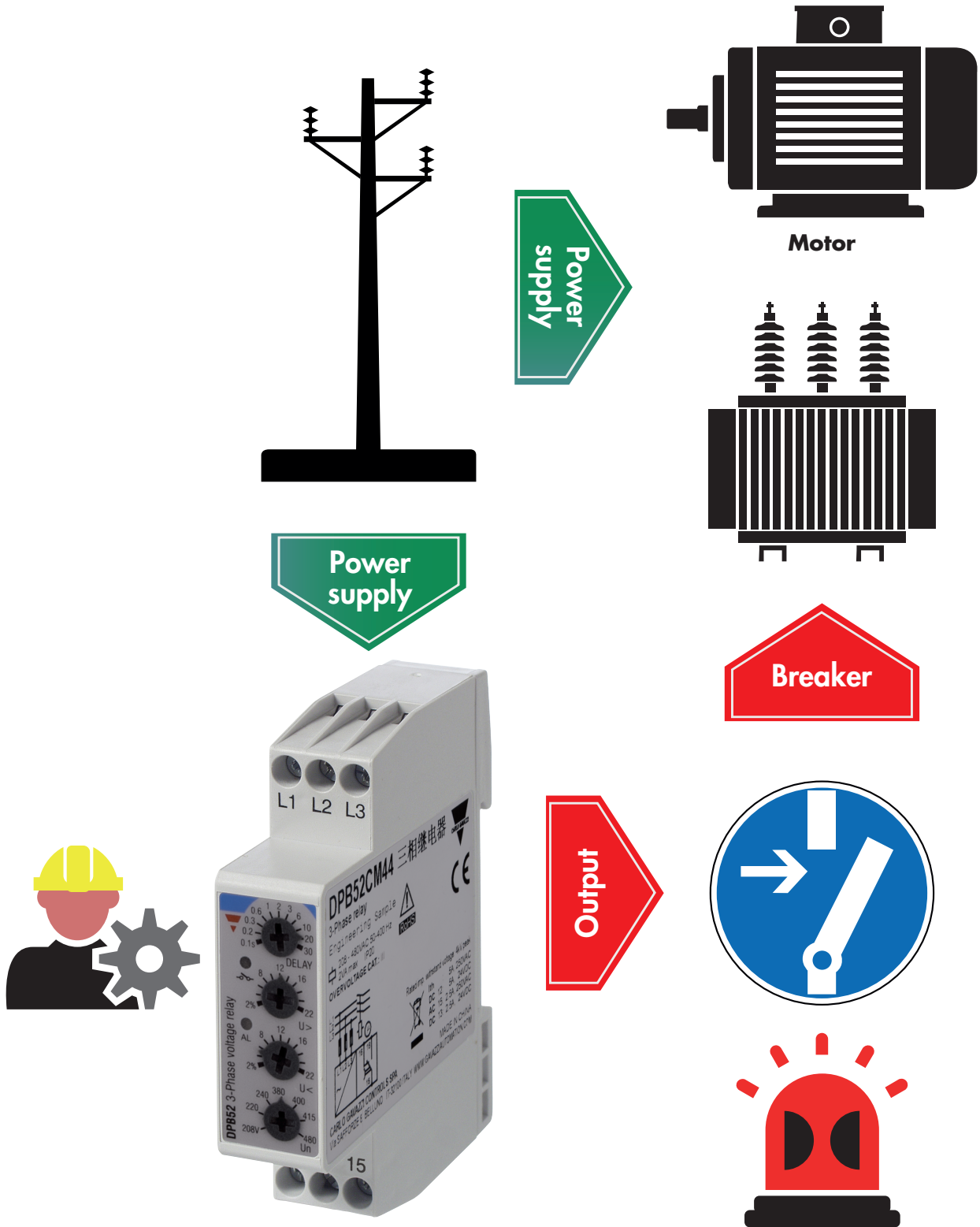

Connection Diagrams

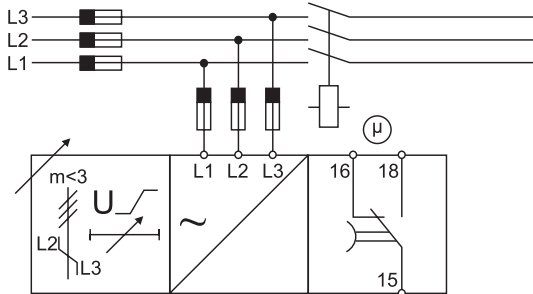

Example 1

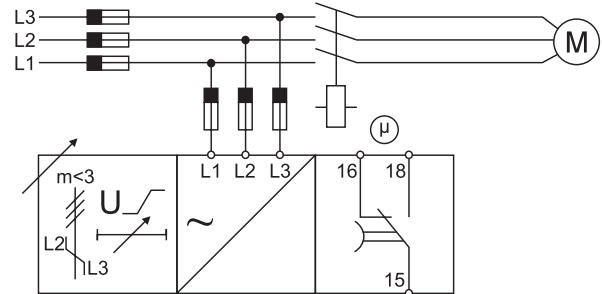

Example 2

Example 1

(mains network monitoring) The relay monitors phase loss, correct phase sequence, over and under voltage.

Example 2

(load monitoring) The relay monitors phase loss, correct phase sequence, over and under voltage of a load.

DPB52

References

Further reading

Information	Where to find it	QR
Instructions Manual	http://www.productselection.net/MANUALS/UK/DPB52_IM.pdf	
Monitoring relays Brochure	http://www.productselection.net/MANUALS/UK/BRO_Monitoring_2017.pdf	

CARLO GAVAZZI compatible components

-	-	-
---	---	---

Order code



DPB52CM44

