

Monitoring Relays 1-Phase True RMS AC/DC Over and Under Current Types DIC01, PIC01

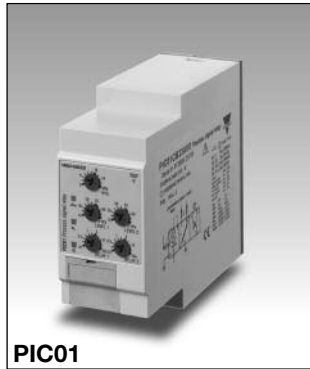

DIC01



PIC01

- TRMS AC/DC over + under, over+over, under+under current and voltage monitoring relays
- DC process signal plus/minus monitoring relay (DIC01)
- Selection of measuring range by DIP-switches
- Adjustable current and voltage on relative scale
- Adjustable hysteresis on relative scale
- Separately adjustable delay functions (0.1 to 30 s)
- Programmable latching or inhibit at set level
- Output: 1 or 2 x 8 A SPDT relay N.D. or N.E. selectable
- For mounting on DIN-rail in accordance with DIN/EN 50 022 (DIC01) or plug-in module (PIC01)
- 45 mm Euronorm housing (DIC01) or 36 mm plug-in module (PIC01)
- LED indication for relay(s), alarm and power supply ON
- Galvanically separated power supply

Product Description

DIC01 and PIC01 are precise TRMS AC/DC over+under, over+over or under+under current and voltage (selectable by DIP-switch) monitoring relays. DIC01 can perform also DC plus/minus measurement by short circuiting pins Z3 and Y1. The devices can be connected to the MI or MP and A82 or E83 current transformers. Both relays have two individual set levels with their

own time delay. Only for DIC01 each set level can work with a single SPDT relay. Owing to the built-in latch function, the ON-position of the relay output can be maintained. Inhibit function can be used to avoid relay operation when not desired (maintenance, transitions). The LED's indicate the state of the alarm and the output relays.

Ordering Key

DIC 01 D B23 AV0

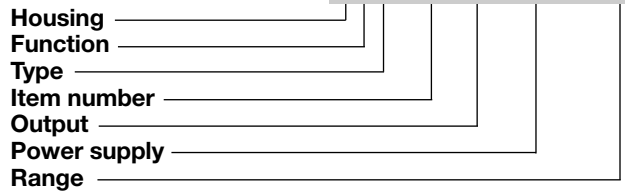

Type Selection

| Mounting | Output | Supply: 24 to 48 VAC/DC | Supply: 115/230 VAC |
|----------|--------|-------------------------|-------------------------|
| DIN-rail | 2xSPDT | DIC 01 D D48 AV0 | DIC 01 D B23 AV0 |
| Plug-in | SPDT | PIC 01 C D48 AV0 | PIC 01 C B23 AV0 |

Input Specifications

| Input | | Measuring voltage ranges | Internal resis. | Max. volt. |
|--|--|----------------------------|----------------------|------------|
| Current level | DIC01: Terminals Y1, Y2 PIC01: Terminals 6, 7 | Direct | | |
| Voltage level | DIC01: Terminals Y1, Y3 PIC01: Terminals 5, 7 | Selectable by DIP-switch | | |
| DC levels (DIC01 only) | Connecting terminals Z3, Y1 | 0.1 to 1 V AC/DC | > 10 kΩ | 7 V |
| Measuring current ranges | | 1 to 10 V AC/DC | > 10 kΩ | 20 V |
| | | 0.4 to 4 V _p AC | > 10 kΩ | 100 V |
| | | -1 to 1 VDC | > 10 kΩ | 7 V |
| | | -10 to 10 VDC | > 10 kΩ | 20 V |
| | | Max. current for 1 s | Max. voltage for 1 s | > 10 kΩ |
| Direct | | | | |
| Selectable by DIP-switch | | | | |
| 0.5 to 5 mA AC/DC | | | | |
| 2 to 20 mA AC/DC | | | | |
| -5 to 5 mA DC | (DIC01 only) | | | |
| -20 to 20 mA DC | | | | |
| Internal resis. | Max. curr. | | | |
| 50 Ω | 35 mA | | | |
| 50 Ω | 55 mA | | | |
| 50 Ω | 35 mA | | | |
| 50 Ω | 55 mA | | | |
| | 100 mA | | | |
| Note 1: The input voltage cannot raise over 300 VAC/DC with respect to ground (PIC01 only) | | | | |

Input Specifications (cont.)

| CT ranges | AAC rms | Max. curr. |
|--|------------------|------------|
| MI and MP ranges (0.4 to 4 V _p input) | | |
| 1-ph.: 3-ph.: | | |
| MI 5 MP 3005 | 0.5 to 5 A | 20 AAC |
| MI 20 MP 3020 | 2 to 20 A | 50 AAC |
| MI 100 MP 3100 | 10 to 100 A | 250 AAC |
| MI 500 MP 3500 | 50 to 500 A | 750 AAC |
| Note 2: MP 3... current transformers not suitable for under current measurements due to the output signal of the device (see data sheet) | | |
| CT ranges (cont.) | AAC rms | Max. curr. |
| A82 ranges (2 to 20 mA input) | | |
| A82-10/20 25 | 2.5 to 25 A | 30 AAC |
| A82-10/20 50 | 5 to 50 A | 60 AAC |
| A82-10/20 100 | 10 to 100 A | 120 AAC |
| A82-10/20 250 | 25 to 250 A | 300 AAC |
| A82-10/20 500 | 50 to 500 A | 600 AAC |
| E83 ranges (2 to 20 mA input) | | |
| E83-20 50 | 5 to 50 A | 100 AAC |
| Contact input | | |
| DIC01 | Terminals Z1, Y1 | |
| PIC01 | Terminals 8, 9 | |
| Disabled | > 10 kΩ | |
| Enabled | < 500 Ω | |
| Latch disable | > 500 ms | |

Output Specifications

| | |
|--|--|
| Output | 1 or 2 x SPDT relays |
| Rated insulation voltage | 250 VAC |
| Contact ratings (AgSnO₂) | μ |
| Resistive loads AC 1 | 8 A @ 250 VAC |
| DC 12 | 5 A @ 24 VDC |
| Small inductive loads AC 15 | 2.5 A @ 250 VAC |
| DC 13 | 2.5 A @ 24 VDC |
| Mechanical life | ≥ 30 x 10 ⁶ operations |
| Electrical life | ≥ 10 ⁵ operations (at 8 A, 250 V, cos φ = 1) |
| Operating frequency | ≤ 7200 operations/h |
| Dielectric strength | |
| Dielectric voltage | ≥ 2 kVAC (rms) |
| Rated impulse withstand volt. | 4 kV (1.2/50 μs) |

Supply Specifications

| | |
|---|---|
| Power supply | Overvoltage cat. III (IEC 60664, IEC 60038) |
| Rated operational voltage through terminals: | |
| A1, A2 or A3, A2 (DIC01) | |
| 2, 10 or 11, 10 (PIC01) | |
| D48: | 24 to 48 VAC/DC ± 15% 45 to 65 Hz, insulated |
| B23: | 115/230 VAC ± 15% 45 to 65 Hz, insulated |
| Dielectric voltage | DC supply AC supply |
| Supply to input | 2 kV 4 kV |
| Supply to output | 4 kV 4 kV |
| Input to output | 4 kV 4 kV |
| Rated operational power | |
| AC | 5 VA |
| DC | 3 W |

General Specifications

| | | | |
|-----------------------|--|-------------------------|--|
| Power ON delay | 1 s ± 0.5 s or 6 s ± 0.5 s | Housing | |
| Reaction time | (input signal variation from -20% to +20% or from +20% to -20% of set value) | Dimensions | DIC01 PIC01 |
| Alarm ON delay | < 100 ms | Material | 45 x 80 x 99.5 mm 36 x 80 x 94 mm PA66 or Noryl |
| Alarm OFF delay | < 100 ms | Weight | Approx. 250 g |
| Accuracy | (15 min warm-up time) | Screw terminals | |
| Temperature drift | ± 1000 ppm/°C | Tightening torque | Max. 0.5 Nm acc. to IEC 60947 |
| Delay ON alarm | ± 10% on set value ± 50 ms | Product standard | EN 60255-6 |
| Repeatability | ± 0.5% on full-scale | Approvals | UL, CSA |
| Indication for | | CE Marking | L.V. Directive 2006/95/EC EMC Directive 2004/108/EC |
| Power supply ON | LED, green | EMC | |
| Alarm ON | LED, red (flashing 2 Hz during delay time) | Immunity | According to EN 60255-26 According to EN 61000-6-2 |
| Output relay ON | 1 or 2 x LED(s), yellow | Emissions | According to EN 60255-26 According to EN 61000-6-3 |
| Environment | (EN 60529) | | |
| Degree of protection | IP 20 | | |
| Pollution degree | 3 (DIC01), 2 (PIC01) | | |
| Operating temperature | -20 to 60°C, R.H. < 95% | | |
| Storage temperature | -30 to 80°C, R.H. < 95% | | |

Mode of Operation

DIC01 and PIC01 monitor both AC and DC current and voltage. DIC01 can also monitor positive and negative DC voltage connecting terminals Y1 and Z3.

Example 1

(no contact input - under+over voltage - 2 x SPDT N.D. relays (1 x SPDT for PIC01) - TRMS)

DIC01: One relay operates when the voltage drops below the under voltage set point for more than the respective delay time. It releases when the voltage exceeds the set level plus the set hysteresis. The other relay operates when the voltage exceeds the over voltage set point for more than the respective delay time. It releases when the voltage drops below the set level minus hysteresis.

PIC01: The relay operates when the voltage drops below the under voltage set level for more than the respective set delay time or when it exceeds the over voltage set level for more than the relative set delay time. The relay releases when the voltage exceeds the under voltage set level plus hysteresis and it drops

below the over voltage set level minus hysteresis (the hysteresis is the same for both set levels).

Example 2

(latch enable active - under+under current - 2 x SPDT relays (1 x SPDT for PIC01) - TRMS)

DIC01: Each relay operates and latches when the current drops below the respective set level for more than the respective delay time. Provided that the current has exceeded the respective set level plus hysteresis, each relay releases when the contact input's connection is interrupted.

PIC01: The relay operates when the current drops below the higher set level for more than the respective delay time. Provided that the current has exceeded the higher set level plus hysteresis the relay releases when the contact input's connections is interrupted.

Note

Different delay times can be used for appropriate reaction according to the set points.

Example 3

(inhibit enable active - over+over current with MI CT - DPDT relay (SPDT for PIC01) - TRMS)

Provided that the contact input's connection is interrupted, the relay operates when the current flowing in the MI CT exceeds the lower set level for more than the respective delay time. It releases when the current drops below the lower set level minus hysteresis or when the contact input's pins are connected.

Example 4

(inhibit enable active - over+over current with A82-10 CT - DPDT relay (1 x SPDT for PIC01) - TRMS)

Provided that the contact input's connection is interrupted, the relay operates when the current flowing in the A82-10 CT exceeds the lower set level for more than its delay time. It releases when the current drops below the lower set level minus hysteresis or when the contact input's pins are connected.

Example 5 (DIC01 only)

(no contact input - under+over voltage - 2 x SPDT N.D. relays - plus/minus DC)

One relay operates when the voltage drops below the under voltage set point for more than the respective delay time. It releases when the voltage exceeds the set level plus the set hysteresis. The other relay operates when the voltage exceeds the over voltage set point for more than the respective delay time. It releases when the voltage drops below the set level minus hysteresis.

In this case the spare front label has to be placed on the device for proper level adjustment.

Note

When the inhibit contact is opened, if the input signal is already in alarm position, the delay time needs to elapse before relay(s) activation.



Function/Range/Level and Time Delay Setting

Adjust the input range setting the DIP switches 1 and 2 of the main black selector as shown below.

Select the desired function setting the DIP switches 3 to 6 of the black selector and 1, 2 of the small red selector as shown below.

To access the DIP switches open the grey plastic cover as shown below

The selection between current and voltage is automatically selected through the input connectors.

TRMS or positive/negative DC monitoring selectable by short-circuiting terminals Y1 and Z3 (DIC01 only).

Selection of level, time delay and hysteresis:

Upper knob:
Setting of hysteresis on relative scale: 0 to 30% on set value.

Centre knobs:
Current level setting on relative scale: 10 to 110% on full scale.

Lower knobs:
Setting of delay on alarm time on absolute scale (0.1 to 30 s).

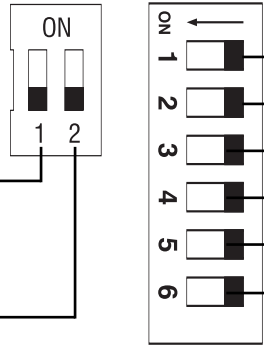
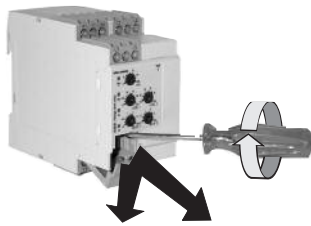

Set Point 2 (SP2) monitoring function
ON: Over current or voltage
OFF: Under current or voltage

Relay(s) coupling
ON: 2 x SPDT (DIC01 only)
OFF: 1 x DPDT (DIC01, PIC01)

| Measuring range (depending on connections) | | | | | |
|--|----------------------------|-----|----------------------|---------------------|--------------------|
| Connect | Input term. | SW1 | ON | ON | OFF |
| | | SW2 | OFF | ON | ON |
| None | DIC01: Y1,Y2 PIC01: 5,7 | | 0.5 to 5 mA AC/DC | 2 to 20 mA AC/DC | None |
| Y1 to Z3 | DIC01: Y1,Y2 | | -5 to +5 mA DC | -20 to +20 mA DC | None |
| None | DIC01: Y1,Y3 PIC01: 6,7 | | 0.1 to 1V AC/DC | 4 V _p | 1 to 10 V AC/DC |
| Y1 to Z3 | DIC01: Y1,Y3 | | -1 to +1 V DC | None | -10 to +10 V DC |

Relay(s) working mode
ON: Normally De-energized (ND)
OFF: Normally Energized (NE)

Power ON delay
ON: 6 s ± 0.5 s
OFF: 1 s ± 0.5 s

Contact input
ON: Latch function enable
OFF: Inhibit function enable

Set Point 1 (SP1) monitoring function
ON: Over current or voltage
OFF: Under current or voltage

Operation Diagrams

Over+over voltage/current - N.D. relay(s)

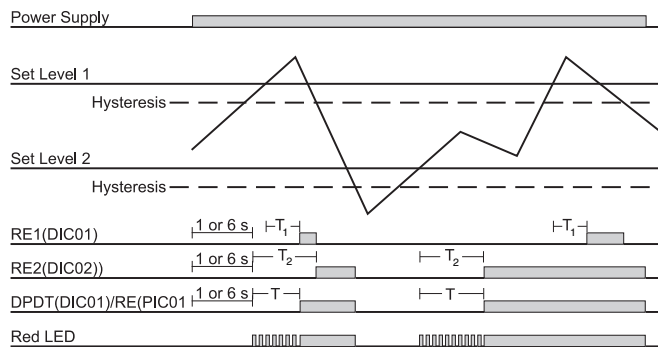

Over+over voltage/current - Latch - N.D. relay(s)

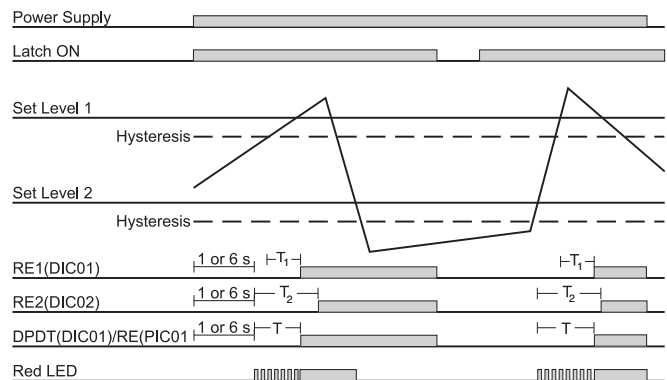

Operation Diagrams (cont.)

Over+under voltage/current - N.E. relay(s)

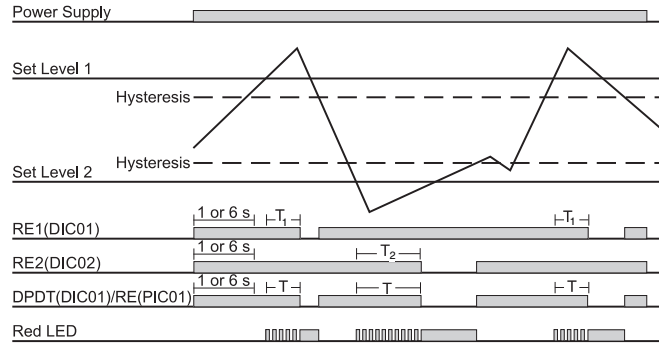

Over+under voltage/current - Inhibit - N.E. relay(s)

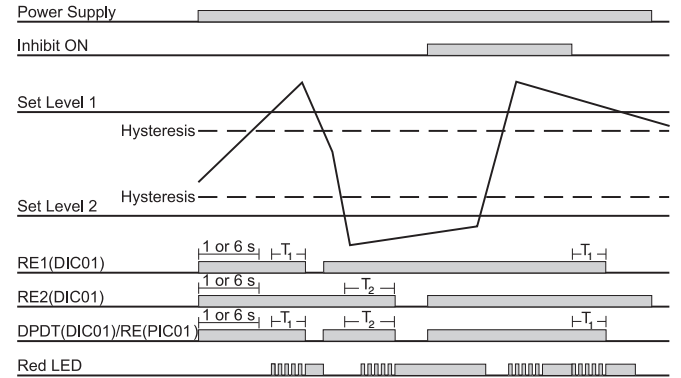

Under+under voltage/current - N.D. relay(s)

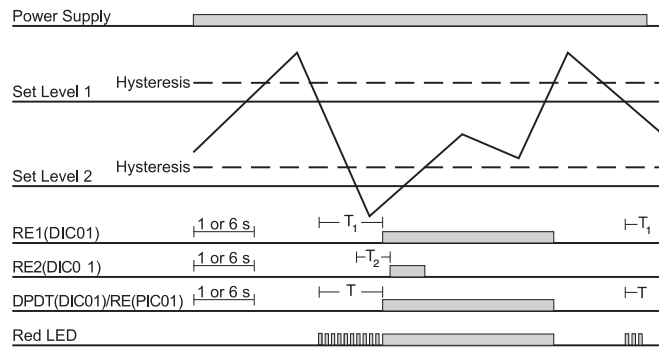

Wiring Diagrams

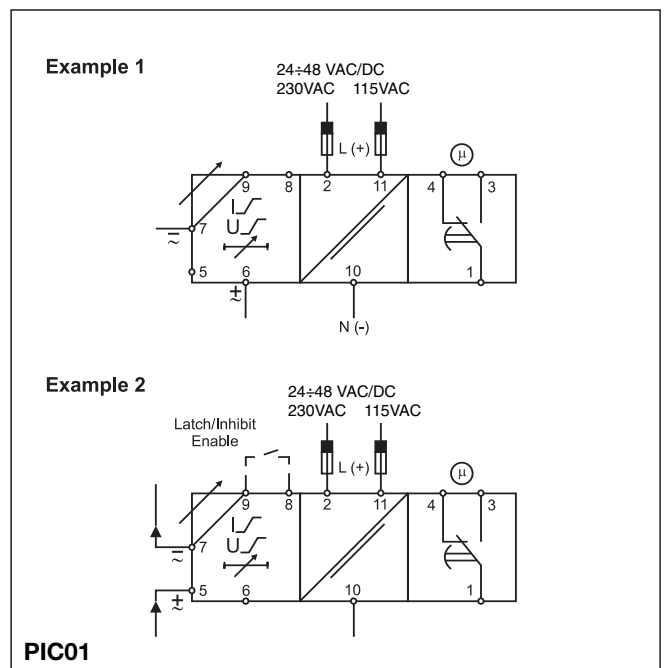
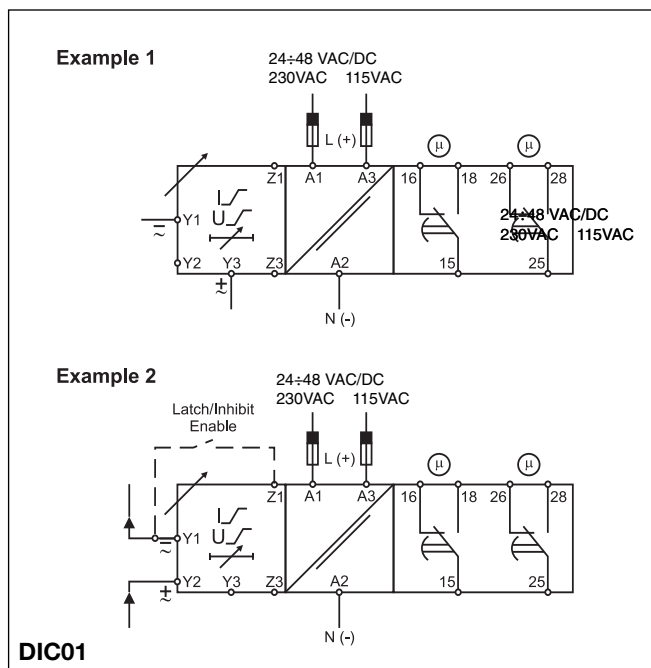

Wiring Diagrams (cont.)

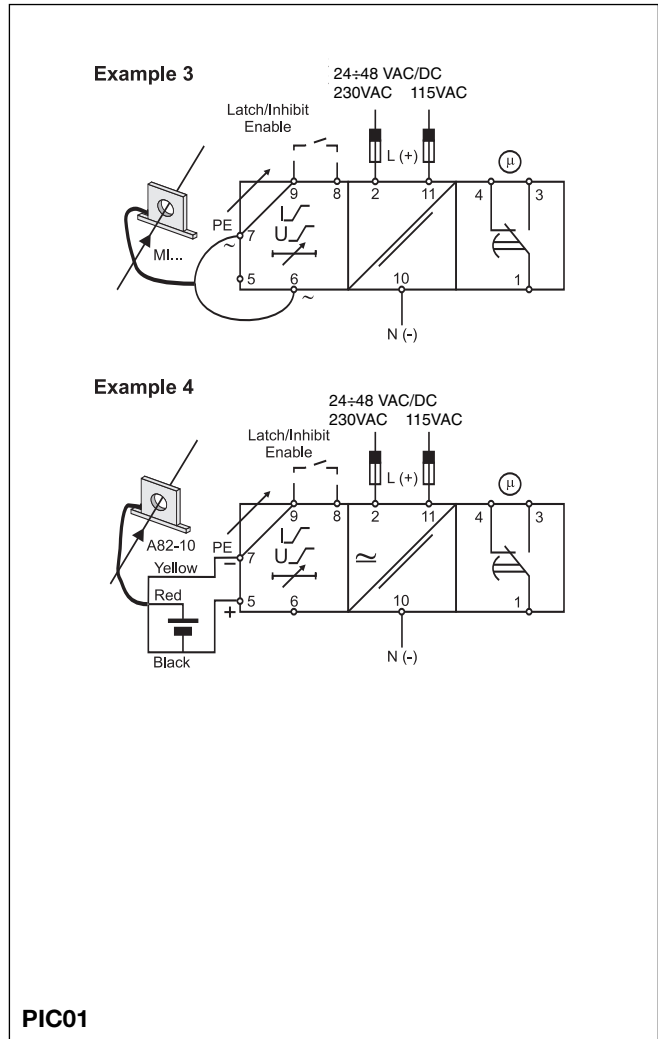
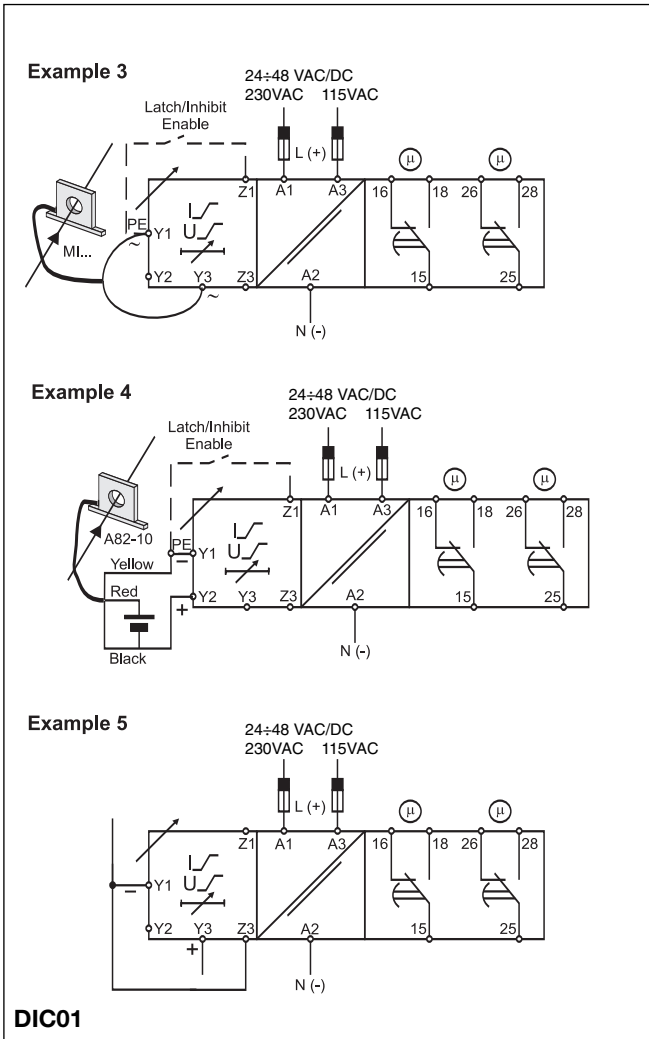

Dimensions

