

## Features

### 25 A modular contactor - 2 pole

- 17.5 mm wide
- NO contact gap  $\geq 3$  mm, double break
- Continuous duty for the coil and contacts
- AC/DC silent coil (with varistor protection)
- Protective separation (reinforced insulation) between coil and contacts
- Mechanical and LED indicators as standard
- Auto-On-Off selector version available
- AgNi and AgSnO<sub>2</sub> contact versions available
- Compliant with EN 61095: 2009
- Auxiliary contact module available, quick-assembly with the main contactor (1 NO + 1 NC and 2 NO versions)
- 35 mm rail (EN 60715) mount

22.32...1xx0 / 22.32...4xx0  
Screw terminal



\* Contact gap  $\geq 3$  mm for NO contacts only;  
NC contacts  $\geq 1.5$  mm  
For outline drawings see page 7

**NEW** 22.32.0.xxx.1xx0



- AgNi contacts, specifically intended for resistive and slightly inductive loads as well as for motor loads

**NEW** 22.32.0.xxx.4xx0



- AgSnO<sub>2</sub> contacts, specifically intended for lamp loads and for high inrush current loads

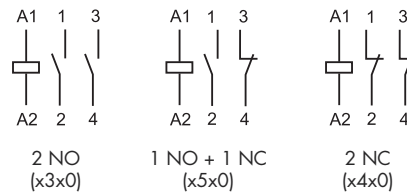

### Contact specification

Contact configuration	2 NO, 3 mm * (or 1 NO + 1 NC or 2 NC)	
Rated current/Maximum peak current	A	25 / 80
Rated voltage	V AC	250 / 440
Rated load AC1 / AC-7a (per pole @ 250 V)	VA	6,250
Rated current AC3 / AC-7b	A	10
Rated load AC15 (per pole @ 230 V)	VA	1,800
Single-phase motor rating (230 V AC)	kW	1
Rated current AC-7c	A	—
230 V lamps rating: incandescent or halogen	W	—
compact fluorescent (CFL)	W	2,000
electronic ballast fluorescent tubes	W	200
electromagnetic ballast compens. fluorescent tubes	W	800
Breaking capacity DC1: 30/110/220 V	A	25/5/1
Minimum switching load	mW (V/mA)	1,000 (10 / 10)
Contact material		AgNi

### Coil specification

Nominal voltage (U <sub>N</sub> )	V DC/AC (50/60 Hz)	12 - 24 - 48 - 60 - 120 - 230
Rated power AC/DC	VA (50 Hz)/W	2 / 2.2
Operating range	DC/AC (50/60 Hz)	(0.8 ... 1.1) U <sub>N</sub>
Holding voltage	DC/AC (50/60 Hz)	0.4 U <sub>N</sub>
Must drop-out voltage	DC/AC (50/60 Hz)	0.1 U <sub>N</sub>

### Technical data

Mechanical life AC/DC	cycles	2 · 10 <sup>6</sup>
Electrical life at rated load AC-7a	cycles	70 · 10 <sup>3</sup>
Operate/release time	ms	30 / 20
Insulation between coil and contacts (1.2/50 μs)	kV	6
Ambient temperature range	°C	-20...+50
Protection category		IP20

### Approvals (according to type)



## Features

### 25 A modular contactor - 4 pole

- 35 mm wide
- NO contact gap  $\geq 3$  mm, double break
- Continuous duty for the coil and contacts
- AC/DC silent coil (with varistor protection)
- Protective separation (reinforced insulation) between coil and contacts
- Mechanical and LED indicators as standard
- Auto-On-Off selector version available
- AgNi and AgSnO<sub>2</sub> contact versions available
- Compliant with EN 61095: 2009
- Auxiliary contact module available, quick-assembly with the main contactor (1 NO + 1 NC and 2 NO versions)
- 35 mm rail (EN 60715) mount

22.34...1xx0 / 22.34...4xx0  
Screw terminal



\* Contact gap  $\geq 3$  mm for NO contacts only;  
NC contacts  $\geq 1.5$  mm  
For outline drawings see page 7

NEW

22.34.0.xxx.1xx0



- AgNi contacts, specifically intended for resistive and slightly inductive loads as well as for motor loads

NEW

22.34.0.xxx.4xx0



- AgSnO<sub>2</sub> contacts, specifically intended for lamp loads and for high inrush current loads

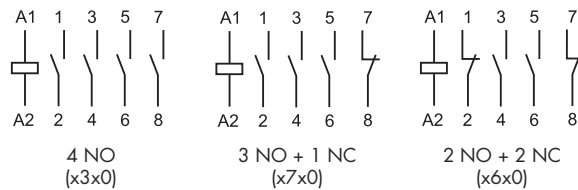

### Contact specification

Contact configuration	4 NO, 3 mm * (or 3NO + 1NC or 2NO + 2NC)	
Rated current/Maximum peak current	A	25 / 80
Rated voltage	V AC	250 / 440
Rated load AC1 / AC-7a (per pole @ 250 V)	VA	6,250
Rated current AC3 / AC-7b	A	10
Rated load AC15 (per pole @ 230 V)	VA	1,800
Three-phase motor rating (400 - 440 V AC)	kW	4
Rated current AC-7c	A	10
230 V lamps rating: incandescent or halogen	W	2,000
compact fluorescent (CFL)	W	200
electronic ballast fluorescent tubes	W	800
electromagnetic ballast compens. fluorescent tubes	W	500
Breaking capacity DC1: 30/110/220 V	A	25/5/1
Minimum switching load	mW (V/mA)	1,000 (10 / 10)
Contact material		AgNi      AgSnO <sub>2</sub>

### Coil specification

Nominal voltage (U <sub>N</sub> )	V DC/AC (50/60 Hz)	12 - 24 - 48 - 60 - 120 - 230
Rated power AC/DC	VA (50 Hz)/W	2 / 2.2
Operating range	DC/AC (50/60 Hz)	(0.8 ... 1.1) U <sub>N</sub>
Holding voltage	DC/AC (50/60 Hz)	0.4 U <sub>N</sub>
Must drop-out voltage	DC/AC (50/60 Hz)	0.1 U <sub>N</sub>

### Technical data

Mechanical life AC/DC	cycles	2 · 10 <sup>6</sup>
Electrical life at rated load AC-7a	cycles	150 · 10 <sup>3</sup>
Operate/release time	ms	18 / 40
Insulation between coil and contacts (1.2/50 μs)	kV	6
Ambient temperature range	°C	-20...+50
Protection category		IP20

### Approvals (according to type)



## Ordering information

Example: 22 series, modular contactor 25 A, 4 NO contacts, coil 230 V AC/DC, AgSnO<sub>2</sub> contacts, Auto-On-Off selector + mechanical indicator + LED.

	<b>2</b>	<b>2</b>	.	<b>3</b>	<b>4</b>	.	<b>0</b>	.	<b>2</b>	<b>3</b>	<b>0</b>	.	<b>4</b>	<b>3</b>	<b>4</b>	<b>0</b>
<p><b>Series</b> _____</p> <p><b>Type</b> 3 = 25 A modular contactor range</p> <p><b>Number of contacts</b> 2 = 2 pole 4 = 4 pole</p> <p><b>Coil version</b> 0 = AC(50/60 Hz)/DC</p> <p><b>Coil rated voltage</b> See coil specifications</p>													<p><b>D: Special versions</b> 0 = Standard</p> <p><b>C: Options</b> 2 = mechanical indicator + LED 4 = Auto-On-Off selector + mechanical indicator + LED</p> <p><b>B: Contact circuit</b> 3 = All NO contacts 4 = All NC contacts (22.32 only) 5 = 1 NO + 1 NC 6 = 2 NO + 2 NC 7 = 3 NO + 1 NC</p> <p><b>A: Contact material</b> 1 = AgNi 4 = AgSnO<sub>2</sub></p>			

**Selecting features and options: only combinations in the same row are possible.**  
Preferred selections for best availability are shown in **bold**.

Type	Coil version	A	B	C	D
22.32	AC/DC	<b>1 - 4</b>	<b>3 - 4 - 5</b>	<b>2 - 4</b>	0
22.34	AC/DC	<b>1 - 4</b>	<b>3 - 6 - 7</b>	<b>2 - 4</b>	0

## Auto-On-Off selector + mechanical indicator + LED (xx40 option)

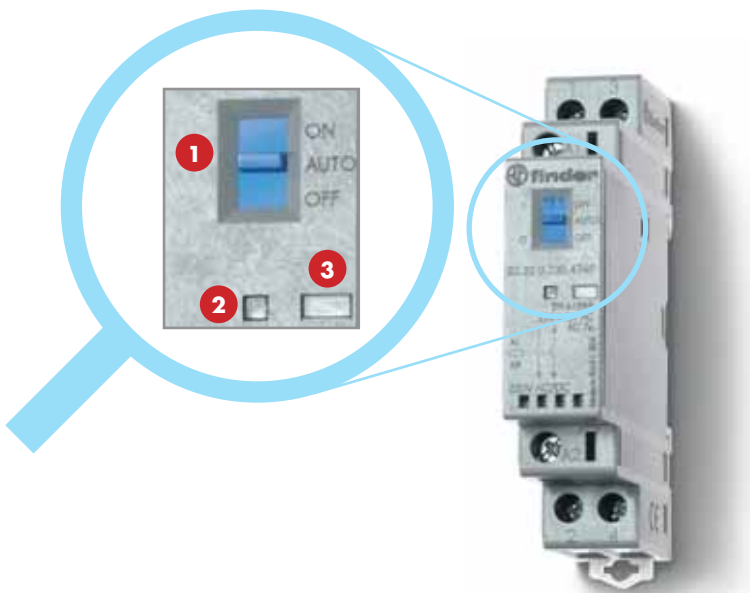

- 1 Selector**  
The three-position manual selector has the following functions:
  - **ON position** - the contacts are latched in the operated state (NO contacts - closed and NC contacts - open), the mechanical indicator is visible in its window, the LED is not illuminated.
  - **AUTO position** - the state of contacts, mechanical indicator and LED follow the coil supply voltage.
  - **OFF position** - even if terminals A1 - A2 are supplied with rated voltage, the coil is not energized, and so the contacts remain in the non-operated state, the mechanical indicator is not visible and the LED is not illuminated.
- 2 LED**
- 3 Mechanical indicator**

## Technical data

Insulation			
Rated insulation voltage	V AC	250	440
Pollution degree		3 *	2
Insulation between coil and contact set			
Type of insulation		Reinforced	
Overvoltage category		III	
Rated impulse voltage	kV (1.2/50 µs)	6	
Dielectric strength	V AC	4,000	
Insulation between adjacent contacts			
Type of insulation		Basic	
Overvoltage category		III	
Rated impulse voltage	kV (1.2/50 µs)	4	
Dielectric strength	V AC	2,500	
Insulation between open contacts		NO contact	NC contact
Contact gap	mm	3	1.5
Overvoltage category		III	II
Rated impulse voltage	kV (1.2/50 µs)	4	2.5
Dielectric strength	V AC/kV (1.2/50 µs)	2,500/4	2,000/3
* Only for versions without Auto-On-Off selector. For versions with Auto-On-Off selector pollution degree 2 applies.			
Conducted disturbance immunity		Reference standard	
Fast transients (burst 5/50 ns, 5 kHz) at coil terminals		EN 61000-4-4	Level 4 (4 kV)
Voltage pulses (surge 1.2/50 µs) at supply terminals (differential mode)		EN 61000-4-5	Level 4 (4 kV)
Short circuit protection			
Rated conditional short circuit current	kA	3	
Back-up fuse	A	32 (gL/gG type)	
Terminals		Solid and stranded cable	
Max. wire size – contact terminals	mm <sup>2</sup>	1 x 6 / 2 x 4	
	AWG	1 x 10 / 2 x 12	
Max. wire size – coil terminals	mm <sup>2</sup>	1 x 4 / 2 x 2.5	
	AWG	1 x 12 / 2 x 14	
Min. wire size – contact and coil terminals	mm <sup>2</sup>	1 x 0.2	
	AWG	1 x 24	
 Screw torque	Nm	0.8	
Wire strip length	mm	9	
Power lost to the environment		22.32	22.34
	without contact current W	2	2
	with rated current W	4.8	6.3

NOTE - It is suggested an air gap of 9 mm between adjacent relays for installations and working conditions close to the limit (that is, ambient temperature > 40 °C, coil operated for a prolonged period of time, all contacts loaded with current > 20 A).

## Contact specification

Ratings and utilization categories according to EN 61095 : 2009									
Utilization category	Typical applications	Load characteristics	Rated current (A)	Rated operational voltage (V)		Rated electrical life (cycles)			
						2-pole AgNi contacts (22.32...1xx0)	2-pole AgSnO <sub>2</sub> contacts (22.32...4xx0)	4-pole AgNi contacts (22.34...1xx0)	4-pole AgSnO <sub>2</sub> contacts (22.34...4xx0)
				across the pole	between phases				
AC-7a	Slightly inductive loads	$\cos \varphi = 0.8$	25	250	440	70 · 10 <sup>3</sup> (NO) 30 · 10 <sup>3</sup> (NC)	30 · 10 <sup>3</sup>	150 · 10 <sup>3</sup> (NO) 100 · 10 <sup>3</sup> (NC)	30 · 10 <sup>3</sup>
AC-7b	Motor loads	$\cos \varphi = 0.45$ $I_{\text{making}} = 6 I_{\text{breaking}}$	10	250	440	30 · 10 <sup>3</sup>	30 · 10 <sup>3</sup>	30 · 10 <sup>3</sup>	30 · 10 <sup>3</sup>
AC-7c	Compensated electric discharge lamps	$\cos \varphi = 0.9$ $C = 10 \mu\text{F/A}$	10	230	400	—	30 · 10 <sup>3</sup>	—	30 · 10 <sup>3</sup>

### H 22 - Maximum DC1 breaking capacity

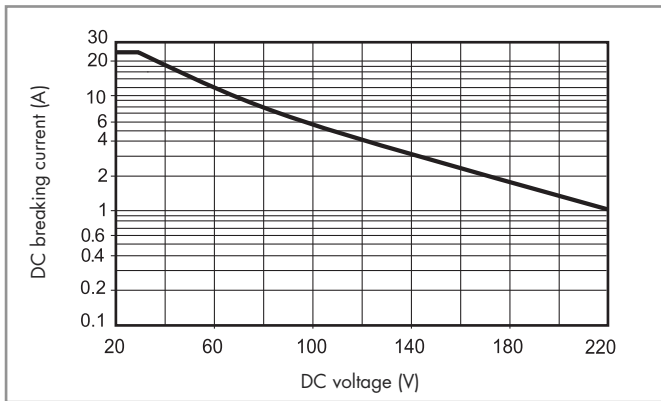

- When switching a resistive load (DC1) having voltage and current values under the curve, an electrical life of  $\geq 100 \cdot 10^3$  can be expected.
- In the case of DC13 loads, the connection of a diode in parallel with the load will permit a similar electrical life as for a DC1 load. Note: the release time for the load will be increased.

## Coil specifications

### AC/DC version data (type 22.32)

Nominal voltage $U_N$	Coil code	Operating range		Rated coil consumption $I_N$ at $U_N$ (AC)
		$U_{\min}$	$U_{\max}$	
V		V	V	mA
12	0.012	9.6	13.2	165
24	0.024	19.2	26.4	83
48	0.048	38.4	52.8	42
60	0.060	48	66	33
120	0.120	88	138	16.5
(110...125)				
230	0.230	184 (AC)	264 (AC)	8.7
(230...240 AC) (220 DC)		176 (DC)	242 (DC)	

### AC/DC version data (type 22.34)

Nominal voltage $U_N$	Coil code	Operating range		Rated coil consumption $I_N$ at $U_N$ (AC)
		$U_{\min}$	$U_{\max}$	
V		V	V	mA
12	0.012	9.6	13.2	165
24	0.024	19.2	26.4	83
48	0.048	38.4	52.8	42
60	0.060	48	66	33
120	0.120	88	138	16.5
(110...125)				
230	0.230	184 (AC)	264 (AC)	8.7
(230...240 AC) (220 DC)		176 (DC)	242 (DC)	

### R 22 - Coil operating range v ambient temperature

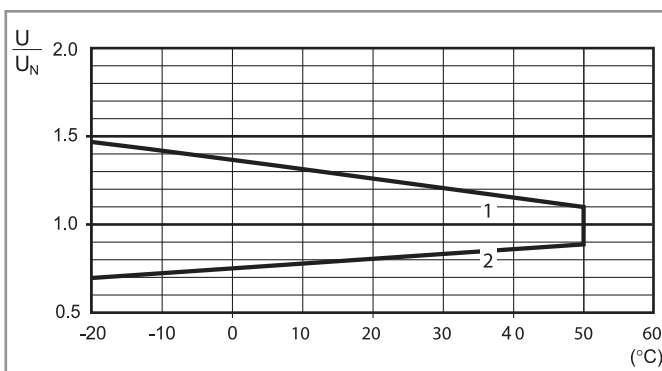

- 1 - Max. permitted coil voltage.  
2 - Min. pick-up voltage with coil at ambient temperature.

**Wiring diagrams**

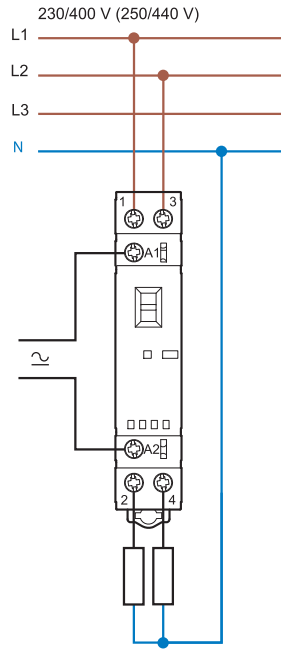

**Type 22.32**

**Line and neutral switched**

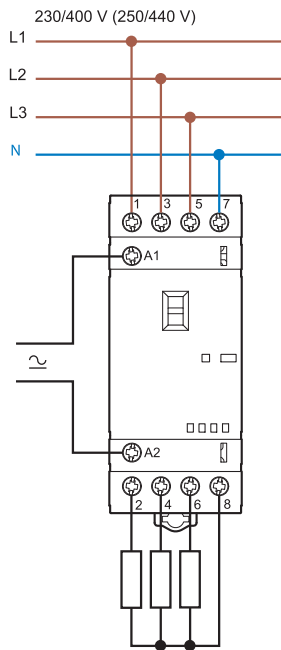

**Type 22.34**

**Line only switched**

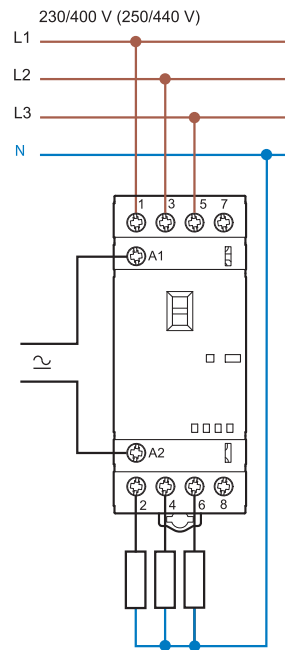

**Type 22.34**

## Outline drawings

Type 22.32  
Screw terminal

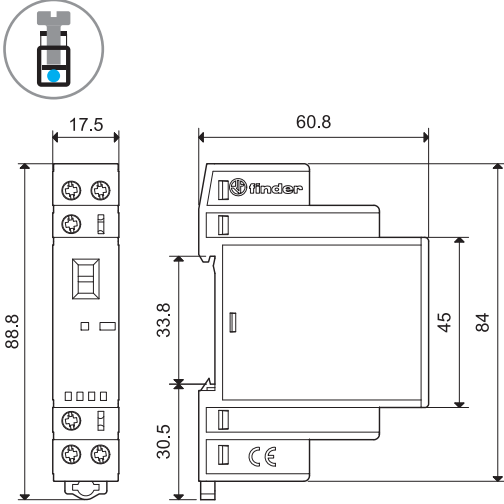

Type 22.32 + 022.33 / 022.35  
Screw terminal

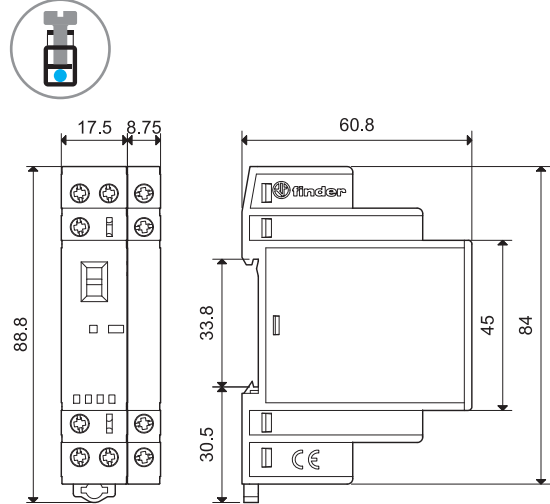

Type 22.34  
Screw terminal

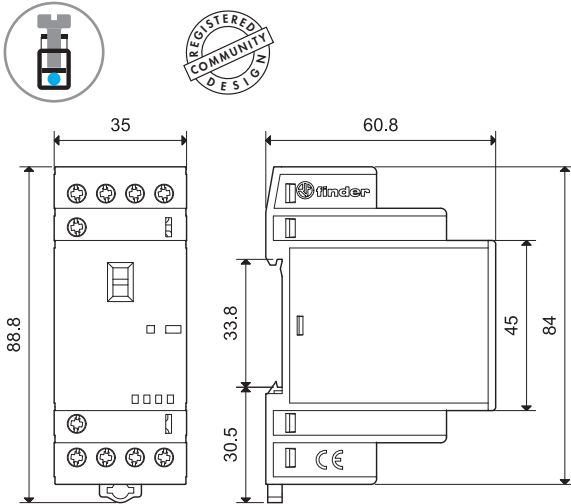

Type 22.34 + 022.33 / 022.35  
Screw terminal

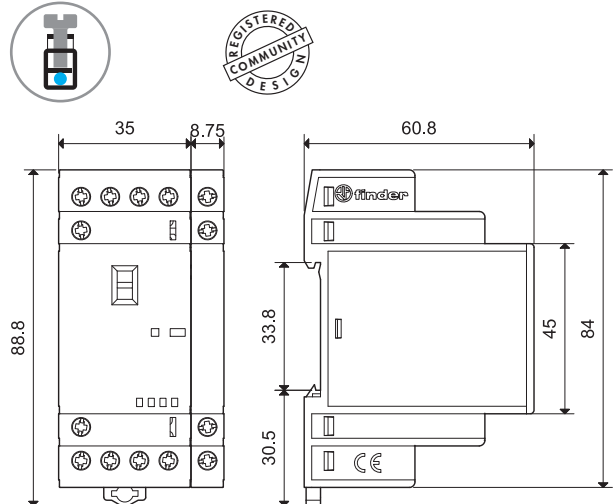

Type 022.33 / 022.35  
Screw terminal

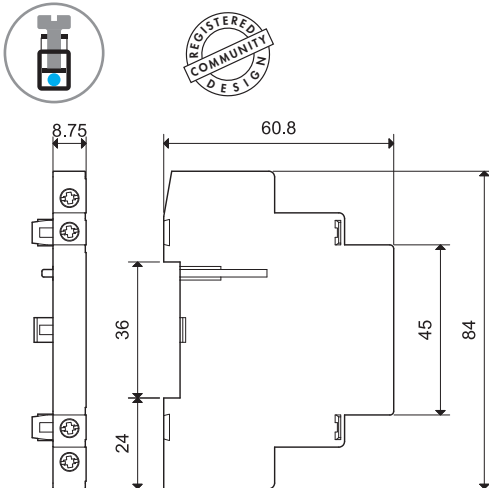

## Auxiliary module 022.33 / 022.35



22.32 + 022.33 / 022.35



22.34 + 022.33 / 022.35

### 022.33



### 022.35



<b>Contact specification</b>			
Contact configuration		2 NO	1 NO + 1 NC
Conventional free air thermal current $I_{th}$	A	6	6
Rated current AC15 (230 V)	VA	700	700
Electrical life at rated load	cycles	$30 \times 10^3$	$30 \times 10^3$
Contact material		AgNi	AgNi
<b>Short circuit protection</b>			
Rated conditional short circuit current	kA	1	
Back-up fuse	A	6 (gL/gG type)	
<b>Terminals</b>		<b>Solid and stranded cable</b>	
Max. wire size	mm <sup>2</sup>	1 x 4 / 2 x 2.5	
	AWG	1 x 12 / 2 x 14	
Min. wire size	mm <sup>2</sup>	1 x 0.2	
	AWG	1 x 24	
Screw torque	Nm	0.8	
Wire strip length	mm	9	
<b>Power lost to the environment</b>			
without contact current	W	—	
with rated current	W	0.5	
<b>Approvals (according to type)</b>			

NOTE: it is not possible to assembly the auxiliary module on 22.32.0.xxx.x4x0 (2 NC versions).



## Accessories



020.01

**Adaptor for panel mounting (for 22.32 type), plastic, 17.5 mm wide**

020.01

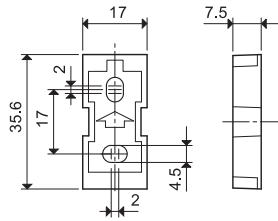

011.01

**Adaptor for panel mounting (for 22.34 type), plastic, 35 mm wide**

011.01

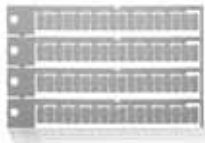
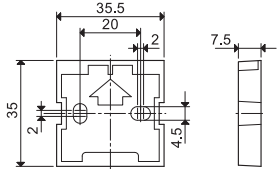

060.72

**Sheet of marker tags, plastic, 72 tags, 6x12 mm**

060.72



019.01

**Identification tag, plastic, 1 tag, 17x25.5 mm**

019.01



020.03

**Separator for rail mounting, plastic, 3 mm wide**

020.03

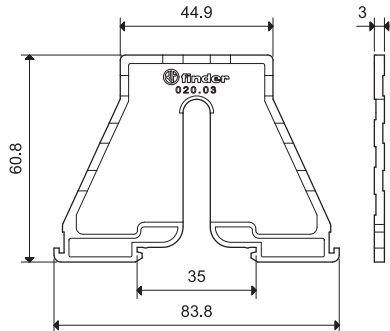

022.18



**8-way jumper link for types 22.32, 17.5 mm wide**

022.18 (blue)

Rated values

10 A - 250 V

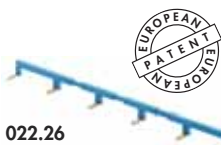
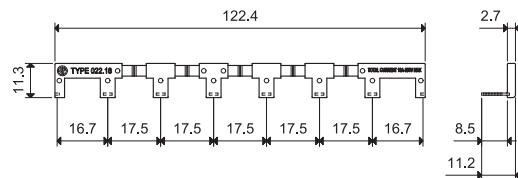

022.26



**6-way jumper link for types 22.34, 35 mm wide**

022.26 (blue)

Rated values

10 A - 250 V

