

IBSHY Insulated Braided Conductor for Compact Circuit Breakers - IBSHY32-700 (558593MTO)



IBSHY is the ideal ready-to-install flexible wire replacement solution that is specifically designed for connections from compact molded case circuit breakers with typical current rating of 125/160 A to copper busbar. The IBSHY connects to the front access terminals of the breakers without any additional accessories, such as angular connectors, spreaders, ring terminal connectors or extenders. IBSHY is available in cross section of 32 mm² (63.15 kcmil), lengths from 230 to 830 mm (9.1" to 32.7").

Manufactured in an ISO 9001 certified proprietary automated facility, IBSHY is formed by weaving high-quality electrolytic copper wire to form a durable low voltage connector with maximum flexibility that allows for more compact power connections to circuit breakers. The IBSHY allows users to reduce the total size and weight of the installation, improving both design flexibility and assembly aesthetics.

The IBSHY features integral pre-punched palms at one end with a pre-punched crimped tube at the other end both of which are ready to connect out of the box. There are no lugs to purchase or install, making connections simpler and faster and eliminating faulty connections due to vibration or fatigue.

These specific shapes give users the possibility to link a compact circuit breaker, or other apparatus, using connection by cage or bolt to a copper busbar with a larger bolt.

The insulation is a high-resistance, self-extinguishing, and halogen free glass fiber reinforced silicon, enabling a high working temperature. IBSHY is compatible with all major brand compact molded case circuit breakers with 125/160 A nominal current.

- Suitable for all main 125/160 A electrical devices and specifically molded case circuit breakers
- Resistant to vibration, improving reliability and performance
- Improves assembly flexibility and aesthetics
- Quick and easy installation
- No additional cutting, stripping, crimping and punching needed
- Small wire diameter provides maximum flexibility
- Halogen free solution for applications requiring a low smoke solution
- Conforms to NF EN 45545 obtaining an HL2 classification for chapters R22 and R23
- High working temperature
- RoHS compliant

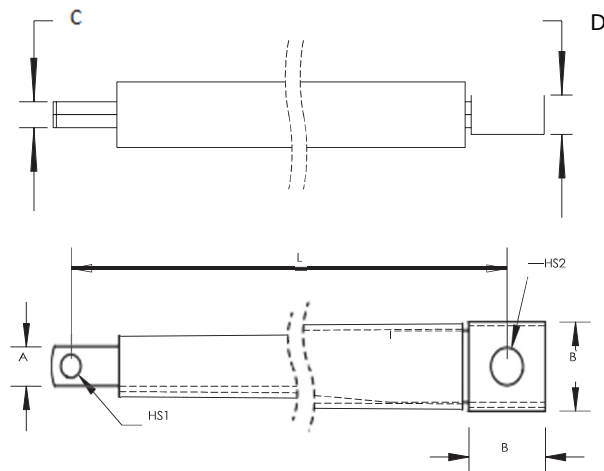



Part Number	IBSHY32-700
Article Number	558593MTO
Typical Application Current Rating	160 A
Finish	Tinned
Material	Copper Glass Fibre Reinforced Silicon
Flammability Rating	UL® 1441 VW-1
Max Working Voltage, IEC (Ui)	1.000 VAC 1.500 VDC
Operating Temperature	-60 to 250 °C
Wire Diameter	0,15 mm
Complies With	IEC® 60439.1 IEC® 61439.1
Cross Section	32 mm²
Length (L)	700 mm
A	11 mm
B	25 mm
C	3 mm
D	5 mm
Hole Size 1 (HS1)	6,5 mm
Hole Size 2 (HS2)	10,5 mm
Unit Weight	0,205 kg
Certifications	CE RoHS
Standard Packaging Quantity	12 pc
UPC	
EAN-13	7090041500075

Maximum Ampacity Ratings															
Cross Section (mm²/kcmil)	ΔT 30° C (A)	ΔT 35° C (A)	ΔT 40° C (A)	ΔT 45° C (A)	ΔT 50° C (A)	ΔT 55° C (A)	ΔT 60° C (A)	ΔT 65° C (A)	ΔT 70° C (A)	ΔT 75° C (A)	ΔT 80° C (A)	ΔT 100° C (A)	ΔT 120° C (A)	2 Bar Current Coefficient	3 Bar Current Coefficient
32/63.15	142	153	164	174	184	193	201	209	217	225	235	263	290	1.6	2

ΔT = Temperature of conductors - Internal temperature of panel.

This table indicates the temperature rise produced by chosen current in the given section. This calculation does not take into account the heat dissipation from the switch gear.

IEC is a registered trademark of the International Electrotechnical Commission. UL, UR, cUL, cUR, cULus and cURus are registered certification marks of ULLLC.

WARNING

Pentair products shall be installed and used only as indicated in Pentair's product instruction sheets and training materials. Instruction sheets are available at erico.pentair.com and from your Pentair customer service representative. Improper installation, misuse, misapplication or other failure to completely follow Pentair's instructions and warnings may cause product malfunction, property damage, serious bodily injury and death and/or void your warranty.

© 2016 Pentair All rights reserved

Pentair, CADDY, CADWELD, CRITEC, ERICO, ERIFLEX, ERITECH and LENTON are owned by Pentair or its global affiliates.

All other trademarks are the property of their respective owners. Pentair reserves the right to change specifications without prior notice.