

POLYLUX,S.L.

Avenida de Roma, 18-26
08290 Cerdanyola del Vallès
Barcelona (Spain)



www.polylux.com/en
Tel : +34 93 594 65 41
export@polylux.com

Kontakt oss:

www.elteco.no
Tlf : 35 56 20 70
firmapost@elteco.no

ELTECO

DATABLAD

TTW250_DYdy12In



Type : TTW_DYdy - Three phase isolation transformer IP23

Technical Characteristics

Rating (kVA)	250 kVA	Effekt
Input Voltage	230V (D) - 400V (YN)	Inngangsspenning
Output Voltage	230V (d) - 400V (yn)	Utgangsspenning
Frequency	50/60Hz	Frekvens
Connection group	Yyn0 – Dyn11 – YNd5 – Dd0 (selectable)	Tilkoblingsgruppe
No load current	< 5% x In	Tomgangsstrøm
No load losses (W)	900 W	Tomgangstap
Load losses (W)	3700 W	Last tap
Efficiency ≥	≥ 98,2 %	Effektivitet
Ambient temperature	40°C	Omgivelsestemperatur
Protection degree	IP23/IK08	Beskyttelsesgrad
Cover	Metal enclosure (epoxy polyester painted, RAL 7035) cat. C3 - ISO12994-2	Kapsling
Cooling	ANAN	Kjøling
Noise level (dB)	< 65 dB	Støynivå
Temperature rise	Class H	Tempearturklasse
Insulation	Class H	Isolasjon
Windings	Class HC – 200°C	Viklinger
Protection	Safety class I	Beskyttelse
Test voltage	3kV (1min, 50Hz)	Testspenning
Standards	IEC-EN 60076, CE	Standarder
Other information:		Annen informasjon:
Inrush <	12 x In	Inrush <
Ek =	3,6 %	Ek
Ex =	3,3 %	Ex
Er =	1,4 %	Er
Width A (mm)	1195	Bredde A (mm)
Deep B (mm)	760	Dyp B (mm)
Height C (mm)	1560	Høyde C (mm)
Installation : fixing		Installasjon
D (mm)	672	D (mm)
E (mm)	690	E (mm)
∅ (mm)	18	∅ (mm)
Weight (kg)	855	Vekt (kg)

More info & check availability : <https://www.elteco.no/3-fase-spenningstrafoer> Mer info og sjekk tilgjengelighet:

Picture

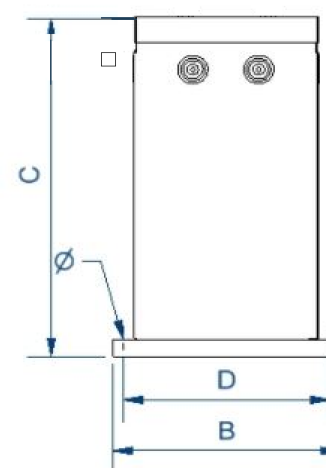
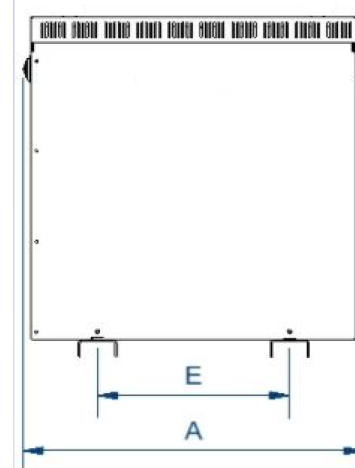

Remark: The dimensions stated at this quotation are approximated and can be modified without previous notification.
Polylux does not accept returns of custom-made products once delivered or cancellation once manufactured
Do not hesitate to contact us for any additional information required

Transformers – Reactors – Harmonic Filters – Stabilisers – Power Supplies

Visit our website www.polylux.com/en