



# RCMA423

## Residual current monitor

for monitoring AC-, DC- and pulsed DC currents  
in TN- and TT systems

Software-Version: D330 V1.0x



**Bender GmbH & Co. KG**

P.O. Box 1161 • 35301 Gruenberg • Germany

Londorfer Strasse 65 • 35305 Gruenberg • Germany

Tel.: +49 6401 807-0 • Fax: +49 6401 807-259

E-Mail: [info@bender.de](mailto:info@bender.de) • [www.bender.de](http://www.bender.de)

© Bender GmbH & Co. KG

All rights reserved.

Reprinting only with permission of the publisher.

Subject to change!

Photos: Bender archives

## Table of Contents

<b>1. Important information</b>	<b>7</b>
1.1 How to use this manual	7
1.2 Technical support: service and support	8
1.2.1 First level support	8
1.2.2 Repair service	8
1.2.3 Field service	9
1.3 Training courses	9
1.4 Delivery conditions	9
1.5 Inspection, transport and storage	10
1.6 Warranty and liability	10
1.7 Disposal	11
<b>2. Safety instructions</b>	<b>13</b>
2.1 General safety instructions	13
2.2 Work activities on electrical installations	13
2.3 Intended use	14
<b>3. Function</b>	<b>15</b>
3.1 Device features	15
3.2 Function	15
3.2.1 Connection monitoring	16
3.2.2 Fast response value query	16
3.2.3 Automatic self test	16
3.2.4 Manual self test	16
3.2.5 Functional faults	17
3.2.6 Setting the number of reload cycles	17
3.2.7 Assigning alarm categories to alarm relays K1/K2	17
3.2.8 Time delays t, ton and toff	17
3.2.9 Residual current monitoring in window discriminator mode	18

3.2.10 Password protection (on, OFF) .....	18
3.2.11 Factory setting FAC .....	18
3.2.12 Erasable history memory .....	18
3.2.13 External, combined test/reset button T/R .....	18
3.2.14 Fault memory .....	18
<b>4. Installation and connection .....</b>	<b>19</b>
<b>5. Operation and setting .....</b>	<b>23</b>
5.1 Display elements .....	23
5.2 Function of the operating elements .....	24
5.3 Menu structure .....	25
5.4 Display in standard mode .....	26
5.5 Display in menu mode .....	27
5.5.1 Parameter query and setting: overview .....	27
5.5.2 Changeover from overcurrent to undercurrent mode or to window mode .....	29
5.5.3 Response value setting for overcurrent: .....	30
5.5.4 Setting the fault memory and alarm relay operating mode .....	31
5.5.5 Assigning alarm categories to the alarm relays .....	32
5.5.6 Setting the time delays .....	34
5.5.7 Changing from overcurrent operation to window operation .....	35
5.5.8 Factory setting and password protection .....	35
5.5.9 Restoring factory settings .....	37
5.5.10 Device information query .....	37
5.5.11 History memory query .....	37

5.6	Commissioning .....	37
5.7	Factory setting .....	38
5.8	Error codes .....	38
<b>6.</b>	<b>Technical data .....</b>	<b>39</b>
6.1	Data in tabular form .....	39
6.2	Standards, approvals and certifications .....	43
6.2.1	Ordering information .....	43
<b>INDEX</b>	<b>.....</b>	<b>45</b>



# 1. Important information

## 1.1 How to use this manual



This manual is intended for **qualified personnel** working in electrical engineering and electronics!

### Always keep this manual within easy reach for future reference.

To make it easier for you to understand and revisit certain sections in this manual, we have used symbols to identify important instructions and information. The meaning of these symbols is explained below:



This signal word indicates that there is a **high risk of danger** that will result in **electrocution** or **serious injury** if not avoided.



This signal word indicates a **medium risk of danger** that can lead to **death** or **serious injury** if not avoided.



This signal word indicates a **low level risk** that can result in **minor** or **moderate injury or damage to property** if not avoided.



This symbol denotes information intended to assist the user in making **optimum use** of the product.

This manual has been compiled with great care. It might nevertheless contain errors and mistakes. Bender cannot accept any liability for injury to persons or damage to property resulting from errors or mistakes in this manual.

## 1.2 Technical support: service and support

For commissioning and troubleshooting Bender offers you:

### 1.2.1 First level support

Technical support by phone or e-mail for all Bender products

- Questions concerning specific customer applications
- Commissioning
- Troubleshooting

**Telephone:** +49 6401 807-760\*  
**Fax:** +49 6401 807-259  
In Germany only: 0700BenderHelp (Tel. and Fax)  
**E-mail:** support@bender-service.de

### 1.2.2 Repair service

Repair, calibration, update and replacement service for Bender products

- Repairing, calibrating, testing and analysing Bender products
- Hardware and software update for Bender devices
- Delivery of replacement devices in the event of faulty or incorrectly delivered Bender devices
- Extended guarantee for Bender devices, which includes an in-house repair service or replacement devices at no extra cost

**Telephone:** +49 6401 807-780\*\* (technical issues)  
+49 6401 807-784\*\*, -785\*\* (sales)  
**Fax:** +49 6401 807-789  
**E-mail:** repair@bender-service.de



Please send the devices for **repair** to the following address:

Bender GmbH, Repair-Service,  
Londorfer Str. 65,  
35305 Grünberg

### 1.2.3 Field service

On-site service for all Bender products

- Commissioning, configuring, maintenance, troubleshooting of Bender products
- Analysis of the electrical installation in the building (power quality test, EMC test, thermography)
- Training courses for customers

**Telephone:** +49 6401 807-752\*\*, -762 \*\* (technical issues)  
+49 6401 807-753\*\* (sales)  
**Fax:** +49 6401 807-759  
**E-mail:** [fieldservice@bender-service.de](mailto:fieldservice@bender-service.de)  
**Internet:** [www.bender-de.com](http://www.bender-de.com)

\*Available from 7.00 a.m. to 8.00 p.m. 365 days a year (CET/UTC+1)

\*\*Mo-Thu 7.00 a.m. - 8.00 p.m., Fr 7.00 a.m. - 13.00 p.m

## 1.3 Training courses

Bender is happy to provide training regarding the use of test equipment. The dates of training courses and workshops can be found on the Internet at [www.bender-de.com](http://www.bender-de.com) -> Know-how -> Seminars.

## 1.4 Delivery conditions

Bender sale and delivery conditions apply.

For software products the "Softwareklausel zur Überlassung von Standard-Software als Teil von Lieferungen, Ergänzung und Änderung der Allgemeinen Lieferbedingungen für Erzeugnisse und Leistungen der Elektroindustrie"

(software clause in respect of the licensing of standard software as part of deliveries, modifications and changes to general delivery conditions for products and services in the electrical industry) set out by the ZVEI (Zentralverband Elektrotechnik- und Elektronikindustrie e. V.) (German Electrical and Electronic Manufacturer's Association) also applies.

Sale and delivery conditions can be obtained from Bender in printed or electronic format.

## 1.5 Inspection, transport and storage

Inspect the dispatch and equipment packaging for damage, and compare the contents of the package with the delivery documents. In the event of damage in transit, please contact Bender immediately.

The devices must only be stored in areas where they are protected from dust, damp, and spray and dripping water, and in which the specified storage temperatures can be ensured.

## 1.6 Warranty and liability

Warranty and liability claims in the event of injury to persons or damage to property are excluded if they can be attributed to one or more of the following causes:

- Improper use of the device.
- Incorrect mounting, commissioning, operation and maintenance of the device.
- Failure to observe the instructions in this operating manual regarding transport, commissioning, operation and maintenance of the device.
- Unauthorised changes to the device made by parties other than the manufacturer.
- Non-observance of technical data.
- Repairs carried out incorrectly and the use of replacement parts or accessories not approved by the manufacturer.
- Catastrophes caused by external influences and force majeure.
- Mounting and installation with device combinations not recommended by the manufacturer.

This operating manual, especially the safety instructions, must be observed by all personnel working on the device. Furthermore, the rules and regulations that apply for accident prevention at the place of use must be observed.

## 1.7 Disposal

Abide by the national regulations and laws governing the disposal of this device. Ask your supplier if you are not sure how to dispose of the old equipment.

The directive on waste electrical and electronic equipment (WEEE directive) and the directive on the restriction of certain hazardous substances in electrical and electronic equipment (RoHS directive) apply in the European Community. In Germany, these policies are implemented through the "Electrical and Electronic Equipment Act" (ElektroG). According to this, the following applies:

- Electrical and electronic equipment are not part of household waste.
- Batteries and accumulators are not part of household waste and must be disposed of in accordance with the regulations.
- Old electrical and electronic equipment from users other than private households which was introduced to the market after 13 August 2005 must be taken back by the manufacturer and disposed of properly.

For more information on the disposal of Bender devices, refer to our homepage at [www.bender-de.com](http://www.bender-de.com) -> Service & support.



## 2. Safety instructions

### 2.1 General safety instructions

Part of the device documentation in addition to this manual is the enclosed "Safety instructions for Bender products".

### 2.2 Work activities on electrical installations



Only **qualified personnel** are permitted to carry out the work necessary to install, commission and run a device or system.



**DANGER**

#### **Risk of electrocution due to electric shock!**

Touching live parts of the system carries the risk of:

- An electric shock
- Damage to the electrical installation
- Destruction of the device

**Before installing and connecting the device, make sure that the installation has been *de-energised*.** Observe the rules for working on electrical installations.

If the device is used outside the Federal Republic of Germany, the applicable local standards and regulations must be complied with. The European standard EN 50110 can be used as a guide.

## 2.3 Intended use

The AC/DC sensitive residual current monitor RCMA423 is designed for use in earthed systems (TN and TT systems) where DC and AC fault currents may occur. These are in particular loads containing six-pulse rectifiers or one way rectifiers with smoothing, such as converters, battery chargers, construction site equipment with frequency-controlled drives.

Two separately adjustable response ranges allow to distinguish between prewarning ( $I_{\Delta n1} = 50 \dots 100$  % of the set response value  $I_{\Delta n2}$ ) and alarm ( $I_{\Delta n2}$ ). Since the values are measured with measuring current transformers, the RCMA423 is nearly independent of the nominal voltage and the current of the system being monitored.

In order to meet the requirements of the applicable standards, customised parameter settings must be made on the equipment in order to adapt it to local equipment and operating conditions. Please heed the limits of the range of application indicated in the technical data.

Any use other than that described in this manual is regarded as improper.

## 3. Function

### 3.1 Device features

- AC/DC sensitive residual current monitor Type B according to IEC 62020 and IEC 60755
- Two separately adjustable response ranges (prewarning, alarm)
- Adjustable switching hysteresis
- r.m.s. value measurement
- Start-up delay, response delay and delay on release
- Measured value display via multi-functional LC display
- Alarm indication via LEDs (AL1, AL2) and changeover contacts (K1, K2)
- N/C operation or N/O operation selectable
- Password protection against unauthorised parameter changing
- Fault memory function can be switched off
- CT connection monitoring

### 3.2 Function

Once the supply voltage  $U_s$  is applied, the start-up delay is activated. Measured values changing during this time do not influence the switching state of the alarm relays. Residual current measurement takes place via external W20AB...W210AB series measuring current transformers. The currently measured value is shown on the LC display. In this way any changes, for example when circuits are connected to the system, can be recognised easily. When the measured values exceed the response values, the response delays  $t_{on1/2}$  begin.

Once the response delay " $t_{on1/2}$ " has elapsed, the "K1/K2" alarm relays switch and the alarm LEDs "AL1/AL2" light up. If the residual current falls below the release value (response value minus hysteresis), the delay on release  $t_{off}$  begins. Once  $t_{off}$  has elapsed, the alarm relays return to their initial position and the alarm LEDs AL1/AL2 go out. If the fault memory is activated, the alarm re-

lays remain in the alarm state and the LEDs light until the reset button is pressed or until the supply voltage is interrupted. The device function can be tested using the test button. The parameterisation of the device can be carried out via the LC display and the control keys integrated in the front plate and can be password-protected.

### 3.2.1 Connection monitoring

The CT connections are continuously monitored. In the event of a fault, the alarm relays K1 / K2 switch without delay, the alarm LEDs AL1 / AL2 / ON flash (Error Code E.01). After eliminating the fault, the alarm relays automatically return to their initial position, provided that the fault memory M is deactivated. With the fault memory activated, K1/K2 return to their initial position by pressing the reset button "R". A second cascaded measuring current transformer will not be monitored.

### 3.2.2 Fast response value query

With the display in standard mode, the currently measured response values  $I_{\Delta n1}$  and  $I_{\Delta n2}$  can be queried pressing the Up and Down keys (< 1.5 s). Switchover to the Menu mode is not required. If you want to exit the fast response value query, press the enter key.

### 3.2.3 Automatic self test

The device automatically carries out a self test after connecting to the system to be monitored and later every 24 hours. During the self test internal functional faults will be detected and appear in form of an error code on the display. The alarm relays are not checked during this test.

### 3.2.4 Manual self test

After pressing the test button for > 1.5 s, the device carries out a self test. During this test, internal functional faults are detected and will be displayed in form of an error code. The alarm relays are not checked during this test. While the test button "T" is pressed and held down, all device-related display elements appear on the display.



### 3.2.5 Functional faults

If an internal functional fault occurs, all of the three LEDs flash. An error code will appear on the display (E01...E32). In such a case please contact the Bender Service.

### 3.2.6 Setting the number of reload cycles

If faults occur only temporarily, but recurrently, in the system being monitored, with the fault memory M deactivated, the alarm relays would switch synchronously to the error status.

RL in the out menu can be used to limit the number of these changeover processes. As soon as the preset number of switching cycles is exceeded, the fault memory will come on and an activated alarm remains stored.

### 3.2.7 Assigning alarm categories to alarm relays K1/K2

The alarm categories device error, residual current  $I_{\Delta n1}$ , residual current  $I_{\Delta n2}$  or alarm by device test can be assigned to the alarm relays via the "out" menu.

### 3.2.8 Time delays $t$ , $t_{on}$ and $t_{off}$

The times  $t$ ,  $t_{on}$  and  $t_{off}$ , described below, delay the output of alarms via LEDs and relays.

#### Start-up delay $t$

After connection to the supply voltage  $U_s$ , the alarm indication is delayed by the preset time  $t$  (0...10 s).

#### Response delay $t_{on1/2}$

If the residual current increases above or falls below the response value, the residual current monitor needs the response time  $t_{an}$  before it signals an alarm. A set response delay  $t_{on1/2}$  (0...10 s) adds up to the device-related operating time  $t_{ae}$  and delays alarm signalling (total delay time  $t_{an} = t_{ae} + t_{on}$ ). If the residual current fault does not continue to exist, an alarm will not be signalled.

### **Delay on release $t_{\text{off}}$**

When no alarm exists after deactivating the fault memory, the alarm LEDs go out and the alarm relays switch back to their initial position. After activating the delay on release (0...99 s), the alarm state is continuously maintained for the selected period.

### **3.2.9 Residual current monitoring in window discriminator mode**

Change the measuring principle by selecting the window mode (SEt / In). In the window discriminator mode, the threshold values I1 and I2 represent the upper and the lower value. If the measured value is not within this area, an alarm is initiated by the device. See page 35.

#### **3.2.10 Password protection (on, OFF)**

When the password protection is activated (on), settings are only possible after entering the correct password (0...999).

#### **3.2.11 Factory setting FAC**

After activating the factory setting, all settings previously changed are reset to delivery status.

#### **3.2.12 Erasable history memory**

The first alarm value that occurs will be saved in this memory. The memory can be cleared via the menu HiS.

#### **3.2.13 External, combined test/reset button T/R**

Reset = Pressing the external button < 1.5 s

Test = Pressing the external button > 1.5 s

#### **3.2.14 Fault memory**

The fault memory can be activated, deactivated or set to continuous mode (con). If the fault memory is set to "con" mode, the alarm parameters remain stored even on failure of the supply voltage. Stored alarms can be reset by means of the reset button R.

## 4. Installation and connection



Only **qualified personnel** are permitted to carry out the work necessary to install, commission and run a device or system.



**DANGER**

### **Risk of electrocution due to electric shock!**

Touching live parts of the system carries the risk of:

- An electric shock
- Damage to the electrical installation
- Destruction of the device

**Before installing and connecting the device, make sure that the *installation* has been *de-energised*.** Observe the rules for working on electrical installations.

## Dimension diagram, drawing for screw mounting, push-wire terminal connection

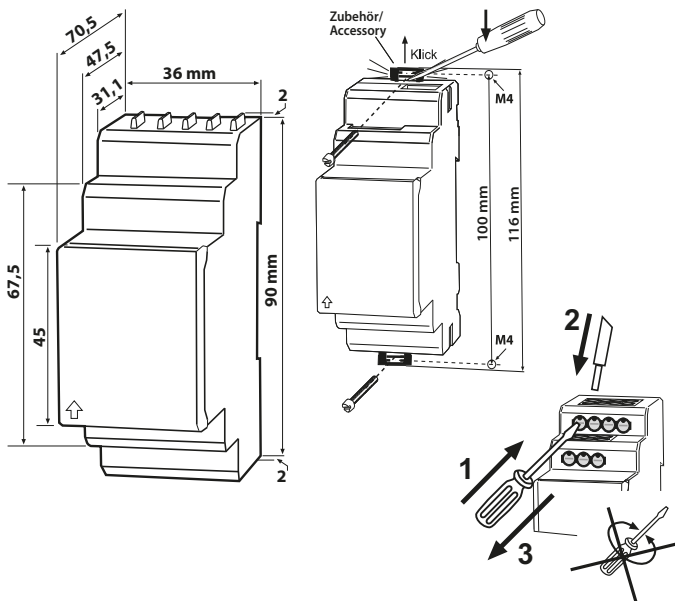

The front plate cover is easy to open at the lower part marked by an arrow.

### 1. DIN rail mounting:

Snap the rear mounting clip of the device into place in such a way that a safe and tight fit is ensured.

### Screw mounting:

Use a tool to move the rear mounting clips (a second mounting clip required, see ordering information) to a position that it projects beyond the enclosure. Then fix the device using two M4 screws.

### 2. Wiring

Connect the device according the wiring diagram.

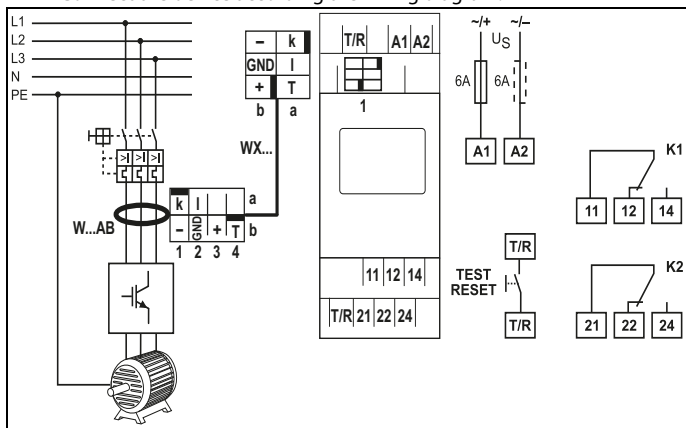



Terminal	Connections
A1, A2	Connection for supply voltage $U_s$
1	Socket for the connecting cable WX... to the measuring current transformer
T/R	Connection for combined test and reset button
11, 12, 14	Alarm relay K1
21, 22, 24	Alarm relay K2



## 5. Operation and setting

### 5.1 Display elements

A detailed description of the meaning of the display elements in use is given in the table below.

Display elements in use	Element	Function
	RL	Reload function with memory = off (L = I.)
	I2	Response value $I_{\Delta n2}$ as mA (Alarm 2)
	I1	Response value $I_{\Delta n1}$ as % of $I_{\Delta n2}$ (Alarm 1, prewarning)
	r1, 1 r2, 2	Alarm relay K1 Alarm relay K2
	I Hys, %	Response value hysteresis as %.
	ton1, ton2, t, toff	Response delay $t_{on1}$ (K1) Response delay $t_{on2}$ (K2) Start-up delay $t$ , Delay on release $t_{off}$ for K1, K2
	M	Fault memory active
		Operating principle of the alarm relays
		Password protection enabled



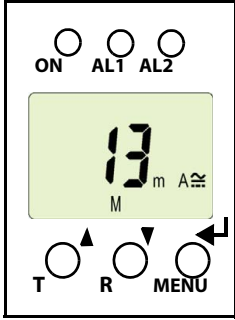

## 5.2 Function of the operating elements

Device front	Element	Function
	<b>ON,</b> <b>green</b>	Lighting continuously: Power On Flashing: system fault or connection monitoring fault
	<b>AL1,</b> <b>AL2</b>	LED Alarm 1 lights (yellow): Response value 1 reached ( $I_{\Delta n1}$ ) LED Alarm 2 lights (yellow): Response value 2 reached ( $I_{\Delta n2}$ )
	<b>13 mA</b> <b>M</b>	13 mA flow through the measuring current transformer, fault memory active
	<b>T,</b> ▲	Test button (> 1.5 s): to indicate the display elements in use, to start a self test; Up key (< 1.5 s): Menu items/values
	<b>R,</b> ▼	Reset button (> 1.5 s): Deleting the fault memory; Down key (< 1.5 s): Menu items/values
	<b>MENU,</b> ◀	MENU key (> 1.5 s): Starting the menu mode; Enter key (< 1.5 s): Confirm menu item, submenu item and value. Enter key (> 1.5 s): Back to the next higher menu level.



### 5.3 Menu structure

All adjustable parameters are listed in the columns "menu item" and "adjustable parameters". A display-like representation is used to illustrate the parameters in the column menu item. Different alarm categories can be assigned to the alarm relays K1, K2 via the submenus r1, r2. This is done by activation or deactivation of the respective function.

Menu	Sub Menu	Menu item	Activation	Adjustable parameter
AL (response - values)		> I2	-(Hi)	$I_{\Delta n2}$ (Alarm 2)
		> I1	-(Hi)	$I_{\Delta n1}$ as % of $I_{\Delta n2}$ (Alarm 1, prewarning)
		Hys	-	Hysteresis $I_{\Delta n1} / I_{\Delta n2}$
out (output control)		M	ON	Fault memory (on/off/con)
		 1	-	Operating mode K1 (n.c.)
		 2	-	Operating mode K2 (n.c.)
		RL	-	Reload function (memory = off)
	r1 (K1: (assignment alarm category))	1 Err	ON	Device error at K1
		r1 I1	ON	Prewarning $I_{\Delta n1}$ at K1
		r1 I2	off	Alarm $I_{\Delta n2}$ at K1
		1 tES	ON	Device test
	r2 (K2: (assignment alarm category))	2 Err	ON	Device error at K2
		r2 I1	off	Prewarning $I_{\Delta n1}$ at K2
		r2 I2	ON	Alarm $I_{\Delta n2}$ at K2
		2 tES	ON	Device test

Menu	Sub Menu	Menu item	Activation	Adjustable parameter
<b>t</b> (timing check)	→	t on 1	-	Response delay K1
		t on 2	-	Response delay K2
		T	-	Start-up delay
		t off	-	Delay on release K1/K2
<b>Set</b> (device control)	→	I 12	HI	Selectable parameters: High, window function, low
			off	Parameter setting via password
		FAC	-	Restore factory settings
		SYS	-	Function blocked
<b>InF</b>	→		-	Display hard / software version
<b>HiS</b>	→	Clr	-	History memory for the first alarm value, erasable

## 5.4 Display in standard mode

By default, the currently measured residual current is displayed. The current response values I1 (prewarning) and I2 (alarm) can be displayed using the Up and Down key. Press the Enter key to return to the measured value.

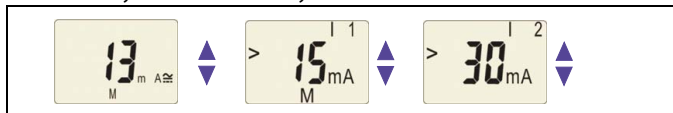

*In the standard mode, the currently set response values I1 and I2 can be displayed using the Up and Down keys.*

## 5.5 Display in menu mode

### 5.5.1 Parameter query and setting: overview

Menu item	Adjustable parameter
AL	Response values query and setting: <ul style="list-style-type: none"> <li>- Residual current I2 (<math>I_{\Delta n2}</math>) (AL2)</li> <li>- Residual current I1 (<math>I_{\Delta n1}</math>) (AL1)</li> <li>- Hysteresis of the response values: % Hys</li> </ul>
out	Configuration of the fault memory and the alarm relay: <ul style="list-style-type: none"> <li>- Activate/deactivate the fault memory or assign continuous mode (on/off/con)</li> <li>- Select N/O operation (n.o.) or N/C operation (n.c.) individually for each K1/K2</li> <li>- Specify the number of the reload cycles</li> <li>- Assign the alarm category I1 (<math>I_{\Delta n1}</math>) or I2 (<math>I_{\Delta n2}</math>), relay test or device error individually to K1/K2 (1, r1/ 2, r2).</li> </ul>
t	Set delays: <ul style="list-style-type: none"> <li>- Response delay <math>t_{on1}/t_{on2}</math></li> <li>- Start-up delay t</li> <li>- Delay on release <math>t_{off}</math> (LED, relay)</li> </ul>
SEt	Device control parameter setting: <ul style="list-style-type: none"> <li>- Select the appropriate parameter for response values: overcurrent mode (HI), undercurrent mode (Lo) or window mode (In).</li> <li>- Enable or disable password protection, change the password.</li> <li>- Restore factory settings.</li> <li>- Service menu SyS blocked</li> </ul>
InF	Query hard and software version
HiS	Query the first stored alarm value
ESC	Move to the next higher menu level (back)

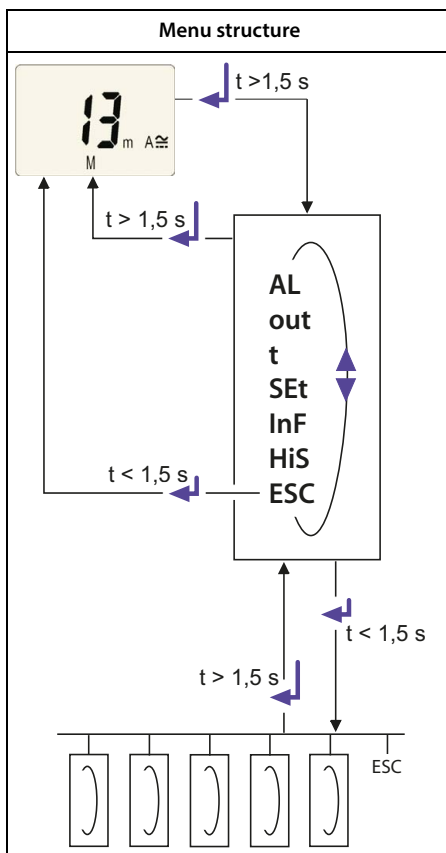

## Parameter settings

An example is given here on how to change the alarm response value I1 ( $I_{\Delta n1}$ ). It is presumed that the option overcurrent (HI) has been selected in the SEt/I 12 menu (factory setting). Proceed as follows:

1. Press the MENU/Enter key for more than 1.5 seconds. The flashing short symbol AL appears on the display.
2. Confirm with Enter. The parameter response value > I2 flashes, in addition the associated overcurrent value > 30 mA appears.
3. Use the Down key to select the parameter response value I1. The parameter I1 flashes, in addition the associated percentage value for prewarning 50 % of I2 appears.
4. Confirm with Enter. The current value for prewarning appears on the flashing display.
5. Use the Up or Down key to set the appropriate prewarning value. Confirm with Enter. I1 flashes.
6. You can exit the menu by:
  - pressing the Enter key for more than 1.5 seconds to reach the next higher level or
  - selecting the menu item ESC and confirming with Enter to reach the next higher level.



*The currently active segments are flashing! In the figures below, the segments where device settings can be carried out are highlighted by an oval. The menu mode can be reached by pressing the MENU key for more than 1.5 seconds.*

### 5.5.2 Changeover from overcurrent to undercurrent mode or to window mode

The operating mode can be changed in the SEt/I 12 menu using the parameters HI, Lo and In. By default, overcurrent operation (HI) is set. Refer to page 35 for a detailed description on how to change over to the window mode.

### 5.5.3 Response value setting for overcurrent:

- Response value I2 (overcurrent  $I_{\Delta n2}$ )
- Response value I1 (overcurrent  $I_{\Delta n1}$ )
- Hysteresis (Hys) of the response values  $I_{\Delta n1}$ ,  $I_{\Delta n2}$

#### Increasing the response value I2 (alarm overcurrent)

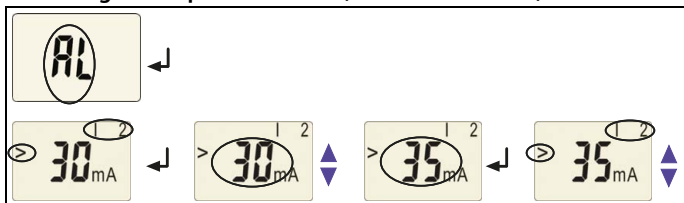

#### Increasing the response value I1 (prewarning overcurrent)

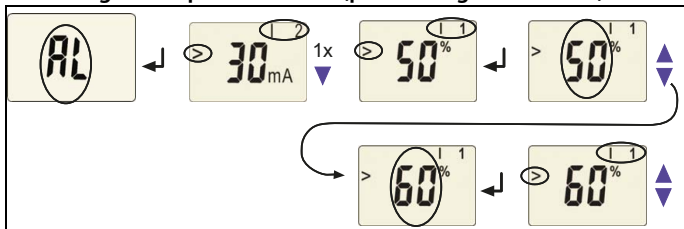

#### Setting the hysteresis of the response value

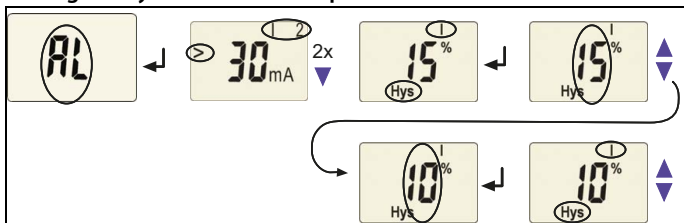

## 5.5.4 Setting the fault memory and alarm relay operating mode

### Setting the fault memory to con mode

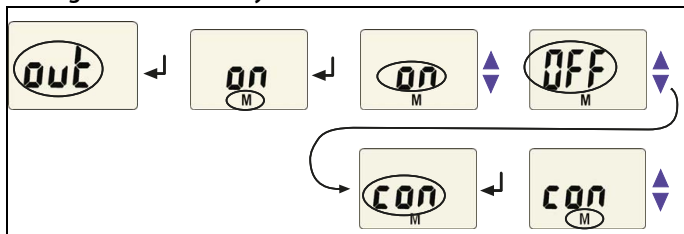

### Setting the alarm relay K1 to N/O operation (n.o.)

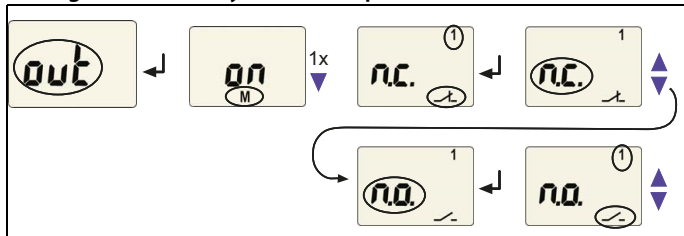

### Setting the number of reload cycles

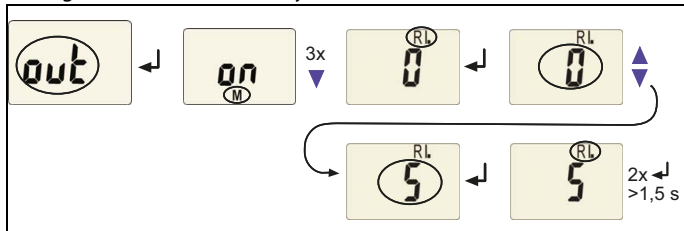

### 5.5.5 Assigning alarm categories to the alarm relays

Overcurrent, undercurrent and device-related errors of the residual current monitor can be assigned to the alarm relays K1 (r1, 1) and K2 (r2, 2). By default, the alarm relays K1 and K2 signal prewarning and alarm in case of overcurrent and device-related errors.

#### Alarm relay K1: Deactivating the category device error

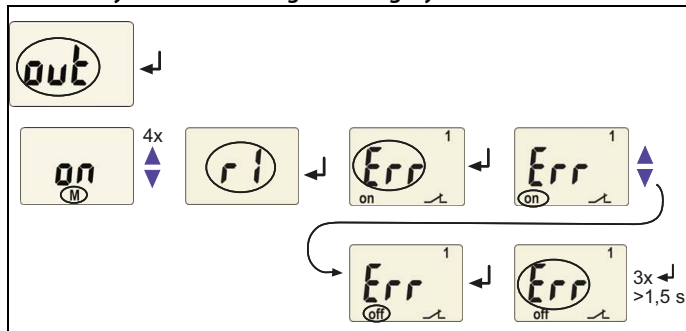

#### Alarm relay K1: Deactivating the category response value I1

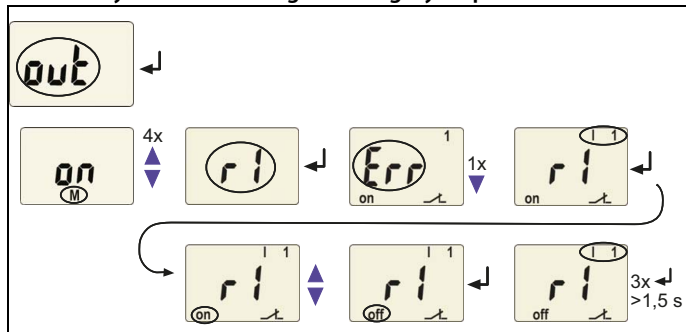



## Alarm relay K1: Activating the category response value I2

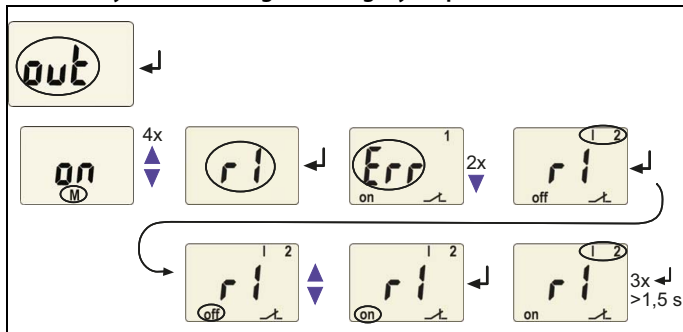

## Alarm relay K1: Deactivating the category "Alarm by device test"

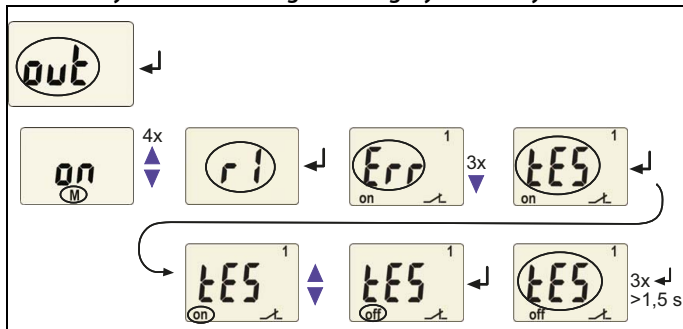

**WARNING**

When an **alarm relay (K1/K2)** has been deactivated in the menu, an **alarm will not be signalled by the respective changeover contact!** An alarm will only be indicated by the respective alarm **LED (AL1/AL2)**!

## 5.5.6 Setting the time delays

The following delays can be set:

- Response delay  $t_{on1}$  (0...10 s) for K1, and  $t_{on2}$  (0...10 s) for K2
- Start-up delay  $t$  (0...10 s) when the device is being started
- Common delay on release  $t_{off}$  (0...99 s) for K1, K2. The setting  $t_{off}$  is only relevant when the fault memory M is deactivated.

The operating steps for the setting of the response delay  $t_{on1}$  and the starting delay  $t$  are illustrated by way of example.

### Setting the response delay $t_{on1}$

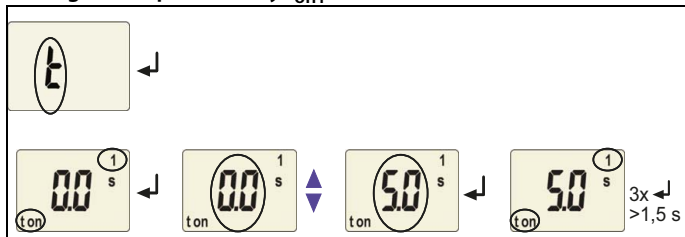

### Setting the start-up delay $t$

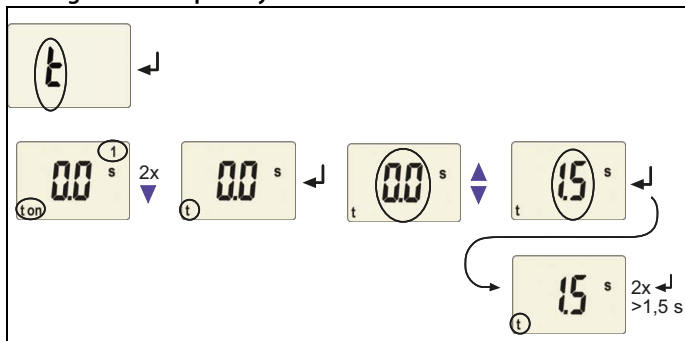

### 5.5.7 Changing from overcurrent operation to window operation

Use this menu item to set whether the response values of the device apply to overcurrent (HI) or undercurrent operation (Lo). In addition, window operation (In) can be selected.

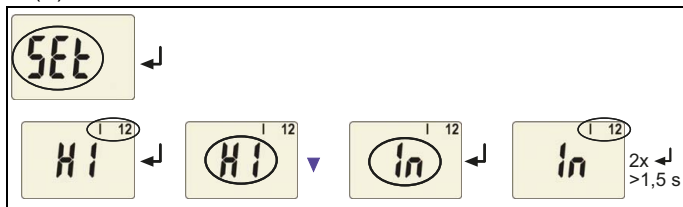

### 5.5.8 Factory setting and password protection

Use this menu to activate the password protection, to change the password or to deactivate the password protection. In addition, you can reset the device to its factory settings.

#### a) Activating the password protection

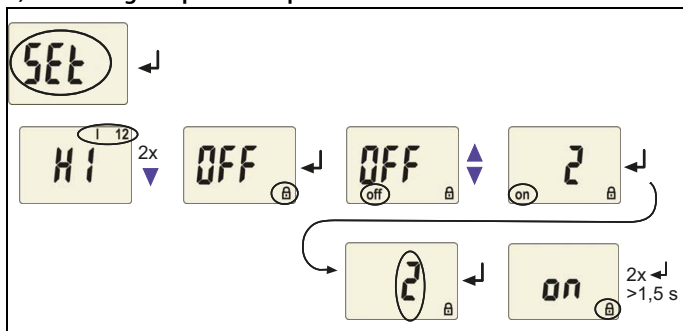

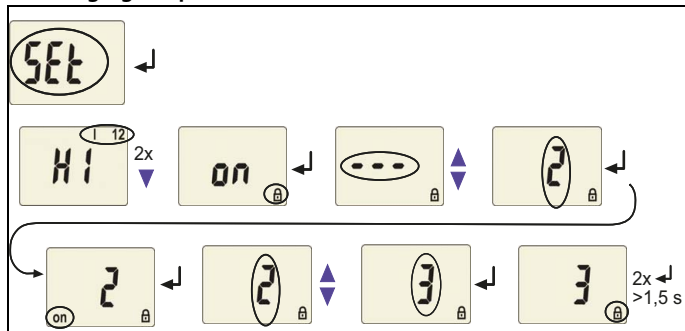
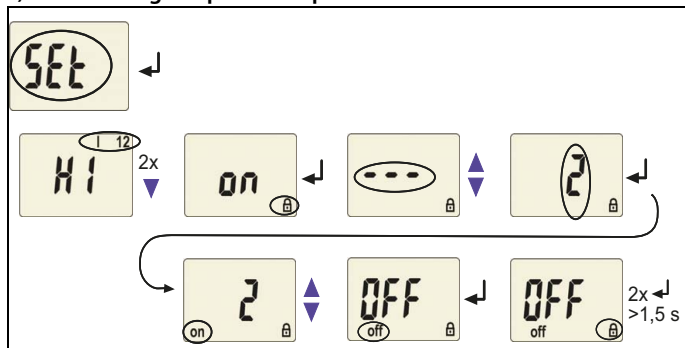
**b) Changing the password**

**c) Deactivating the password protection**

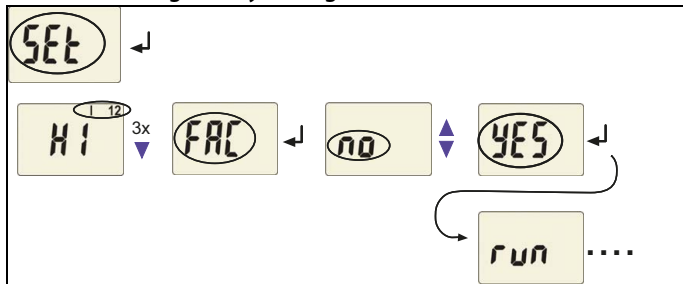
### 5.5.9 Restoring factory settings

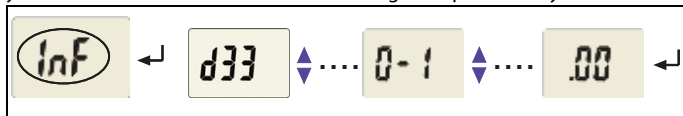

### 5.5.10 Device information query

This function is used to query the software version (1.xx). After activating this function, data will be displayed as a scrolling text. Once one pass is completed you can select individual data sections using the Up/Down keys.



### 5.5.11 History memory query

The history memory can be selected via the menu HiS. Use the Up and Down keys to view the next display. If Clr is flashing, the history memory can be cleared by pressing the Enter key.

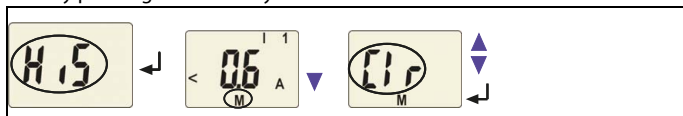

## 5.6 Commissioning

Prior to commissioning, check proper connection of the residual current monitor.

## 5.7 Factory setting



<i>Response value</i>	
- overcurrent I1 (prewarning)	15 mA (50 % of I2)
- overcurrent I2 (alarm)	30 mA
<i>Hysteresis</i>	15 %
<i>Fault memory M</i>	activated (on)
<i>Operating mode K1/K2</i>	N/C operation (n.c.)
<i>Start-up delay</i>	$t = 0.5 \text{ s}$
<i>Response delay</i>	$t_{on1} = 1 \text{ s}$ $t_{on2} = 0 \text{ s}$
<i>Delay on release</i>	$t_{off} = 1 \text{ s}$
<i>Password</i>	0, deactivated (Off)

## 5.8 Error codes

Should, contrary to all expectations, a device error occur, error codes will appear on the display. Typical error codes are described below:

Error code	Meaning:
E.01	Fault CT connection monitoring <b>Appropriate action:</b> Check CT connection for short-circuit or interruption. After eliminating the fault, the error code will be automatically deleted.
E.02	Fault CT connection monitoring during manual self test. <b>Appropriate action:</b> Check CT connection for short-circuit or interruption. After eliminating the fault, the error code will be automatically deleted.
E...	Appropriate action when error codes > 02 occur: <b>Appropriate action:</b> Carry out a reset. Reset the device to factory setting. After eliminating the fault, the error code will be automatically deleted. If the fault continues to exist, please contact the Bender Service.

## 6. Technical data

### 6.1 Data in tabular form

( \*) = factory setting

#### Insulation coordination acc. to IEC 60664-1/IEC 60664-3

RCMA423-D-1:

Rated insulation voltage .....	100 V
Overtoltage category/ pollution degree.....	III/3
Rated impulse voltage .....	2,5 kV

RCMA423-D-2:

Rated insulation voltage .....	250 V
Overtoltage category/ pollution degree.....	III/3
Rated impulse voltage.....	4 kV

#### Supply voltage

RCMA423-D-1:

Supply voltage range $U_s$ .....	AC 24...60 V / DC 24...78 V
Operating range $U_s$ .....	AC 16...72 V / DC 9.6...94 V
Frequency range $f_s$ .....	DC, 42...460 Hz

RCMA423-D-2:

Supply voltage range $U_s$ .....	AC/DC 100...250 V
Operating range $U_s$ .....	AC/DC 70...300 V
Frequency range $f_s$ .....	42...460 Hz

Protective separation (reinforced insulation) between.....	(A1, A2) - (k/I, T/R) - (11, 12, 14) - (21, 22, 24)
Voltage test according to IEC 61010-1 .....	2.21 kV
Power consumption .....	≤ 6,5 VA

#### Measuring circuit

External measuring current transformer .....	W20AB, W35AB(P), W60AB(P), W120AB, W210AB series
Rated insulation voltage (measuring current transformer) .....	800 V
Operating characteristic acc. to IEC 62020 and IEC/TR 60755 .....	Type B
Rated frequency.....	0...2000 Hz

Relative uncertainty for $f \leq 2 \text{ Hz}$ or $\geq 16 \text{ Hz}$ .....	0 ... -35 %
Relative uncertainty for $f > 2 \text{ Hz}$ ... $< 16 \text{ Hz}$ .....	-35 % ... +100 %
Operating uncertainty .....	0 ... 35 %

## Response values

Rated residual operating current $I_{\Delta n1}$ (prewarning, AL1) .....	50 ... 100 % of $I_{\Delta n2}$ (50 %)*
Rated residual operating current $I_{\Delta n2}$ (alarm, AL2) .....	30 mA ... 3 A (30 mA)*
Hysteresis .....	10 ... 25 % (15%)*

## Specified time

Start-up delay $t$ .....	0 ... 10 s (0.5 s)*
Response delay $t_{on1}$ (prewarning) .....	0 ... 10 s (1 s)*
Response delay $t_{on2}$ (alarm) .....	0 ... 10 s (0 s)*
Delay on release $t_{off}$ .....	0 ... 99 s (1 s)*
Operating time $t_{ae}$ bei $I_{\Delta n} = 1 \times I_{\Delta n1/2}$ .....	$\leq 180 \text{ ms}$
Operating time $t_{ae}$ bei $I_{\Delta n} = 5 \times I_{\Delta n1/2}$ .....	$\leq 30 \text{ ms}$
Response time $t_{an}$ .....	$t_{an} = t_{ae} + t_{on1/2}$
Recovery time $t_b$ .....	$\leq 300 \text{ ms}$

## Displays, memory

Display range, measured value AC/DC .....	0 ... 6 A
Error of indication .....	$\pm 17.5 \%$ / $\pm 2$ digit
Measured-value memory for alarm value .....	data record measured values
Password .....	off / 0 ... 999 (off)*
Fault memory alarm relay .....	on / off (on)*

## Inputs/outputs

Cable length for external test / reset button .....	0 ... 10 m
---	------------

## Cable lengths for measuring current transformers

Connection WX ... (see ordering information on page 43) .....	1 m / 2.5 m / 5 m / 10 m
or alternatively: single wire $6 \times 0.75 \text{ mm}^2$ .....	0 ... 10 m



## Switching elements

Number of switching elements .....	2 x 1 changeover contact				
Operating principle .....	N/C operation / N/O operation (N/C operation)*				
Electrical endurance, number of cycles .....	10 000				
Contact data acc. to IEC 60947-5-1					
Utilisation category .....	AC-13.....	AC-14.....	DC-12.....	DC-12.....	DC-12
Rated operational voltage .....	230V .....	230V .....	24V .....	110V .....	220 V
Rated operational voltage UL .....	200V .....	200V .....	24V .....	110V .....	200 V
Rated operational current .....	5 A.....	3 A.....	1 A.....	0.2 A.....	0.1 A
Minimum contact rating .....	1 mA at AC/DC $\geq$ 10 V				

## Environment / EMC

EMC .....	EN 61326-1
Ambient temperatures:	
Operating temperature .....	-25...+55 °C
Transport .....	-25...+70 °C
Long-term storage .....	-25...+55 °C
Classification of climatic conditions acc. to IEC 60721:	
Stationary use (IEC 60721-3-3) .....	3K5 (no condensation, no formation of ice)
Transport (IEC 60721-3-2) .....	2K3
Long-term storage (IEC 60721-3-1) .....	1K4
Classification of mechanical conditions acc. to IEC 60721:	
Stationary use (IEC 60721-3-3) .....	3M4
Transport (IEC 60721-3-2) .....	2M2
Long-term storage (IEC 60721-3-1) .....	1M3

## Option "W" data different from the standard version

Classification of climatic conditions acc. to IEC 60721:	
Stationary use (IEC 60721-3-3) .....	3K5 (condensation and formation of ice is possible)
Classification of mechanical conditions acc. to IEC 60721:	
Stationary use (IEC 60721-3-3) .....	3M7

## Connection

For UL application ..... use 60°C/70°C copper conductors only

Connection type ..... **screw-type terminals**

Connection properties:

rigid/ flexible/ conductor sizes ..... 0.2...4 / 0.2...2.5 mm<sup>2</sup> / AWG 24...12

Multi-conductor connection (2 conductors with the same cross section):

rigid, flexible ..... 0.2...1.5 / 0.2...1.5 mm<sup>2</sup>

Stripping length ..... 8...9 mm

Tightening torque ..... 0.5...0.6 Nm

Connection type ..... **push-wire terminals**

Connection properties:

Rigid ..... 0.2...2.5 mm<sup>2</sup> ( AWG 24...14)

Flexible without ferrules ..... 0.75...2.5 mm<sup>2</sup> ( AWG 19...14)

Flexible with ferrules ..... 0.2...1.5 mm<sup>2</sup> ( AWG 24...16)

Stripping length ..... 10 mm

Opening force ..... 50 N

Test opening, diameter ..... 2.1 mm

## Other

Operating mode ..... continuous operation

Position of normal use ..... display-oriented

Degree of protection, internal components (IEC 60529) ..... IP30

Degree of protection, terminals (IEC 60529) ..... IP20

Enclosure material ..... polycarbonate

Flammability class ..... UL94V-0

DIN rail mounting acc. to ..... IEC 60715

Screw mounting ..... 2 x M4 with mounting clip

Software version ..... D330 V1.0x

Weight ..... ≤ 150 g

( ) \* = factory setting

## Residual operating current ranges of the different measuring current transformers

Residual operating current ranges	Art. No.
30 mA...500 mA	W20AB
30 mA...3 A	W35AB(P) W60AB(P) W120AB
300 mA...3 A	W210AB

## 6.2 Standards, approvals and certifications



### 6.2.1 Ordering information

	RCMA423-D-1	RCMA423-D-2
Response range $I_{\Delta n}$	30 mA...3 A	30 mA...3 A
Rated frequency	0...2000 Hz	0...2000 Hz
Supply voltage $U_s^*$	DC 9.6...94 V / AC 42...460 Hz, 16...72 V	DC 70...300 V / AC 42...460 Hz, 70...300 V
Art. No. (B7... = push-wire terminal)	B 7404 3023 B 7404 3023W B 9404 3023 B 9404 3023W	B 7404 3025 B 7404 3025W B 9404 3025 B 9404 3025W
<b>*Absolute values of the voltage range</b>		

## External measuring current transformers

Type	Inside diameter (mm)	Art. No.
W20AB	20	B 9808 0008
W35AB	35	B 9808 0016
W35ABP	35	B 9808 0051
W60AB	60	B 9808 0026
W60ABP	60	B 9808 0052
W120AB	120	B 9808 0041
W210AB	210	B 9808 0040

## Measuring current transformer connecting cable

Type	Length (m)	Art. No.
WX-100	1	B 9808 0503
WX-250	2,5	B 9808 0504
WX-500	5	B 9808 0505
WX-1000	10	B 9808 0506

## RCMA423 accessories

Mounting clip for screw mounting (1 piece per device) ..... B 9806 0008

## Measuring current transformers accessories

Snap-on mounting for DIN rail: W20AB /W35AB(P) .....B 9808 0501

Snap-on mounting for DIN rail: W60AB(P) .....B 9808 0502

# INDEX

## A

- Adjustable parameters, list 25
- Automatic self test 16

## C

- Connection of an additional cascaded measuring current transformer 23

## D

- Delay on release toff 18
- Deleting the fault alarms 24
- Device features 15
- Display elements 23
- Display in standard mode 26

## E

- Enter key 24
- Error codes 44
- Example of parameter setting 29

## F

- factory setting 18, 38
- Function 15
- Functional faults 17

## H

- How to use this manual 7

## I

- Installation and connection 19
- Intended use 14

## K

- K1/K2: assignment alarm category 25

## L

- LED Alarm 1 lights 24
- LED Alarm 2 lights 24

## M

- Manual self test 16
- Measuring current transformer connecting cable 44
- Measuring current transformer types 44
- Menu
  - AL (response values) 25
  - HiS (history memory for the first alarm value) 26
  - InF (hard and software version) 26
  - Set (device control 26
  - t (timing check) 26
- Menu structure, overview 25

- O**
- Operating elements, function 24
  - Operation and setting 23
  - Ordering information 43
- P**
- Parameter query and setting, overview 27
  - Parameter setting
    - Activating or deactivating the password protection 35
    - Activating the fault memory 31
    - Assigning alarm categories to the alarm relays 32
    - Changeover from overcurrent operation to window operation 35
    - Set response values 30
    - Setting the time delays 34
  - Password protection 18
- R**
- Reset button 24
  - Residual current monitoring in window discriminator mode 18
  - Residual operating current ranges of the different measuring current transformers 43
  - Residual operating current ranges and the appropriate measuring current transformers 43
  - Response delay ton 17
- S**
- Select the appropriate parameter for
    - response values
      - 27
    - Service 8
    - Set response values
      - Hysteresis 30
      - Overcurrent (> I) 30
    - Setting the number of reload cycles 31
    - Starting delay t 17
    - Starting the menu mode 24
    - Support 8
- T**
- Technical data 39
  - Test button 24
  - Training courses 9
- W**
- Window operation 35
  - Wiring diagram 21
  - Work activities on electrical installations 13 workshops 9





**Bender GmbH & Co. KG**

P.O. Box 1161 • 35301 Gruenberg • Germany  
Londorfer Strasse 65 • 35305 Gruenberg • Germany  
Tel.: +49 6401 807-0 • Fax: +49 6401 807-259  
E-Mail: [info@bender.de](mailto:info@bender.de) • [www.bender.de](http://www.bender.de)

Photos: Bender archives



**BENDER Group**