

63A energy meter, MID direct connection

Codes: **CE4DF30PMID – CE4DF3DTMID – CE4DF3MTMID**
 Model: **CONTO D4-Pd**



Contents	Pages
1. Use	1
2. Range	1
3. Installation	1
4. Dimensions	1
5. Connections	2
6. Operating data	2
7. General features	3
8. Conformity and certifications	6
9. Communication	7

1. USE

Three-phase active and reactive energy meter with direct connection. The device, in 4 DIN modules, is self-powered and is equipped with ModBus or MBus communication or pulse output and double tariff input.

MID certification

2. RANGE

Code Art.	Model	Connection	Weight
CE4DF30PMID	Pulse	Screw terminals	0,210Kg
CE4DF3DTMID	Double tariff ModBus		
CE4DF3MTMID	Double tariff MBus		

3. INSTALLATION

Fixing:

On EN/IEC 60715 symmetric rail or DIN 35 rail.

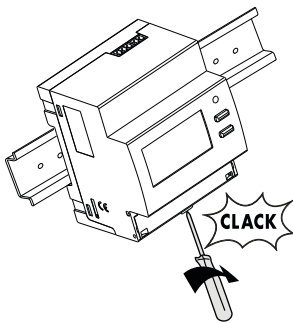

Necessary tools:

For fastening the device on the DIN rail: 5.5 mm flat screwdriver (from 4 to 6 mm).

Operating position:

Vertical, Horizontal, Upside down, On the side



4. DIMENSIONS

Housing: 4 DIN43880 modules

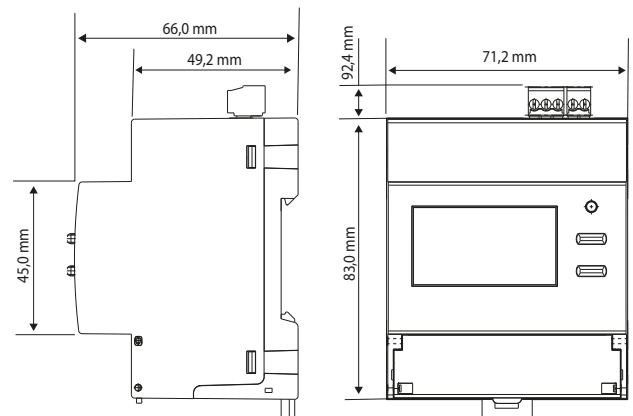

63A energy meter, MID direct connection

Codes: CE4DF30PMID – CE4DF3DTMID – CE4DF3MTMID

Model: CONTO D4-Pd

5. CONNECTIONS

Wiring diagrams:

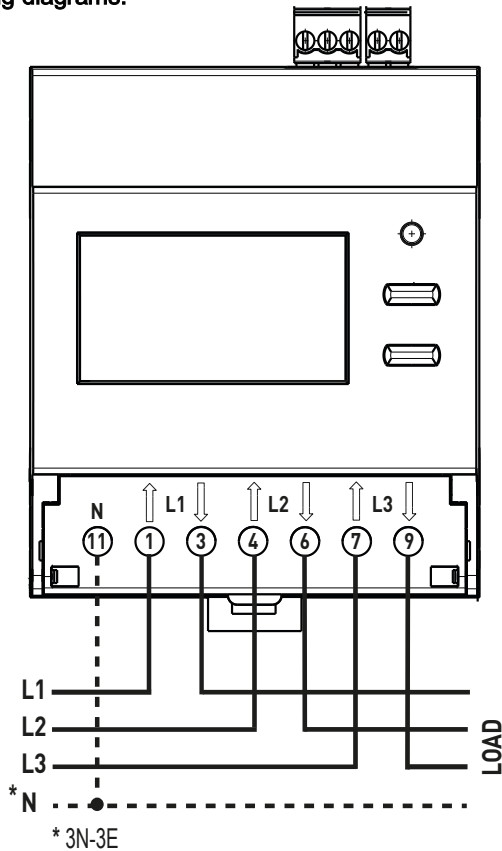

Terminal board marking and diagram combination:

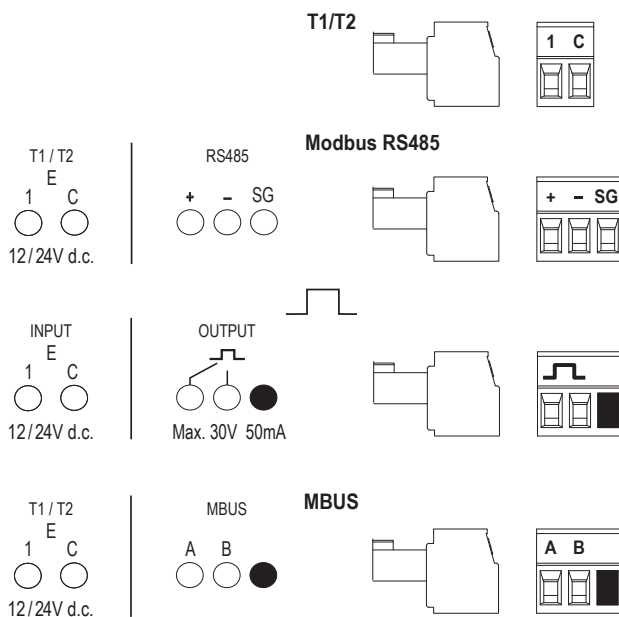

6. OPERATING DATA

6.1 ELECTRIC DATA

Currents:

- Reference current, I_{ref} : 5A
- Minimum current, I_{min} : 0,25A
- Maximum current, I_{max} : 63A

Rated voltages:

- Three-phase rated voltage U_n : 3x230V~ / 3x400V~ ±15%

Rated frequency:

- F_n : 50Hz; 60Hz
- Permitted variation: 49...51Hz; 59...61Hz

Connectable section:

- Copper wires
- Voltage connection terminals (L1, L2, L3, N):

	Without bush	With bush
Rigid wire	1 x 0,75 + 16 mm ²	-
Flexible wire	1 x 0,75 + 10 mm ²	1 x 4 + 10 mm ²

- Terminal boards in the upper part of the meter (input, impulse output and Mbus):

	Without bush	With bush
Rigid wire	1 x 0,2 + 1,5 mm ²	-
Flexible wire	1 x 0,2 + 1 mm ²	1 x 0,2 + 1 mm ²

Necessary tools:

- For the voltage connection terminals (L1, L2, L3): screwdriver with 6mm blade or Pozidriv No. 2
- For the Neutral (N) connection terminal: screwdriver with 6mm blade or Pozidriv No. 2
- For the terminal boards in the upper part of the meter (input, impulse output and bus): screws with 2.5mm blade

63A energy meter, MID direct connection

Codes: CE4DF30PMID – CE4DF3DTMID – CE4DF3MTMID
Model: CONTO D4-Pd

6.2 MECHANICAL DATA

Screw terminals:

- Depth of the terminals: 12mm
- Lengths of the wire stripping: 11mm

Screw head:

- Voltage connection terminals (L1, L2, L3): screws with countersunk head with hexagon socket and Pozidriv No. 2
- Neutral (N) connection terminal: screw/screws with countersunk head with hexagon socket and Pozidriv No. 2
- Terminal boards in the upper part of the meter (input, impulse output and bus): screws with countersunk head with hexagon socket

Recommended torque:

- Voltage connection terminals (L1, L2, L3): from 1.6Nm to 2Nm
- Neutral (N) connection terminal: from 1.6Nm to 2Nm
- Terminal boards in the upper part of the meter (input, impulse output and bus): 0.2 N/m

Terminal protection:

- The power terminals are protected with sliding and sealable terminal front covers which are integrated in the device

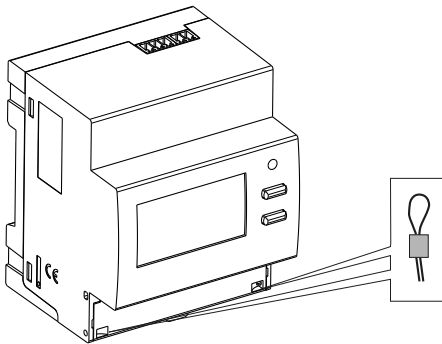

7. GENERAL FEATURES (continues)

Marking data:

Indelible marking

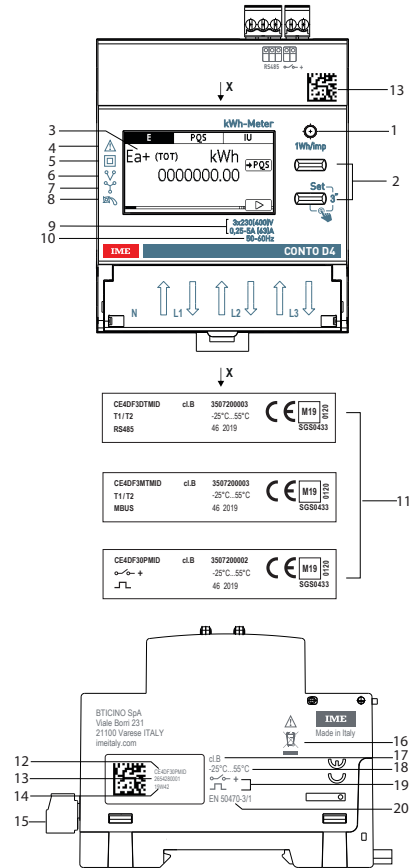

1. Metrological LED
2. Keypad made up of 2 double-function pushbuttons (display/configurations)
3. Graphic display
4. Consult the user manual before installation
5. Double insulation
6. Connection on 3-wire three-phase line
7. Connection on 4-wire three-phase line
8. Anti-rotation device (anti-decreasing)
9. Voltage/Current
10. Frequency
11. MID label
12. Product code
13. Datamatrix for product traceability
14. Week and year of manufacture
15. Output connection terminals
16. RAEE Symbol
17. Precision class
18. Temperature of use
19. Outputs
20. MID standard

63A energy meter, MID direct connection

Codes: CE4DF30PMID – CE4DF3DTMID – CE4DF3MTMID
Model: CONTO D4-Pd

7. GENERAL FEATURES

Laser marking

Left side
Traceability information

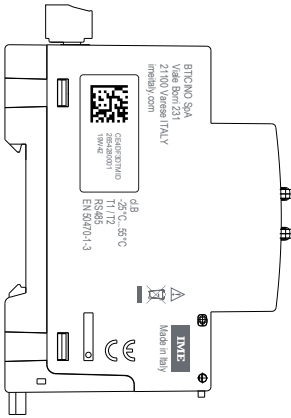

Right side
Wiring diagram

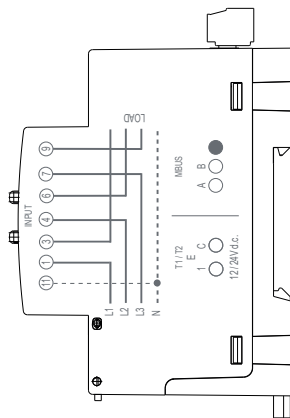
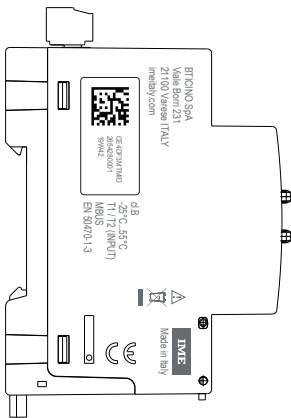
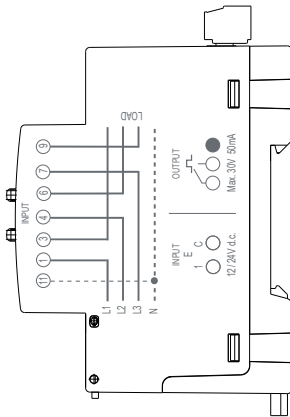
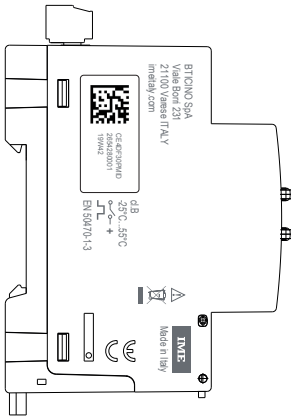
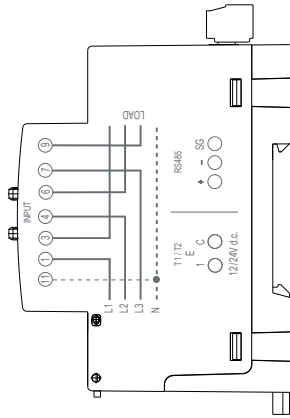

7. GENERAL FEATURES (continues)

Display:

- Graphic, backlit, 1.8 inches (256x128).

Resolution:

- Total meters: 0,01kWh/kvarh
- Partial meters: 0,01kWh/kvarh
- Tariff meters: 0,01kWh/kvarh

Maximum indication

- Total meters: 9 999 999,99
- Partial meters: 9 999 999,99
- Tariff meters: 9 999 999,99

Metrological LED: 1Wh/imp.

Display of the value and programming:

- By means of the front keypad, 2 pushbuttons.
- Change protected by identification code (**predefined code 1000**); the code can be changed during the programming procedure.

Measurements and precision in conformity with EN/IEC 61557-12

- Current: cl.0,5
- Voltage: cl.0,5
- Frequency: $\pm 0,1$ Hz
- Instantaneous total active power, phase, average value and max. average value cl.1
- Instantaneous total active power, phase, average value and max. average value: cl.1
- Instantaneous total reactive power, phase: cl.2
- Instantaneous total apparent power, phase: cl.1
- Power Factor: cl.1

Average power:

- Measurement: active power
- Calculation: moving average, on the selected period
- Average time: 5/8/10/15/20/30/60 min.

Hour meter:

- Counting of operating hours and minutes (**resettable meter**)
- Resolution: 7 figures (5 for the hours + 2 for the minutes)
- Maximum display: 99 999.59 (tariff total)
- Programmable value: 0...50% Pn (positive)

63A energy meter, MID direct connection

Codes: CE4DF30PMID – CE4DF3DTMID – CE4DF3MTMID

Model: CONTO D4-Pd

7. GENERAL FEATURES

Digital input

- The digital input allows switching the energy counting on 2 tariffs
- 2 input terminals with common point (1 - C)
- Rated voltage: 12 – 24V d.c. max. 10mA

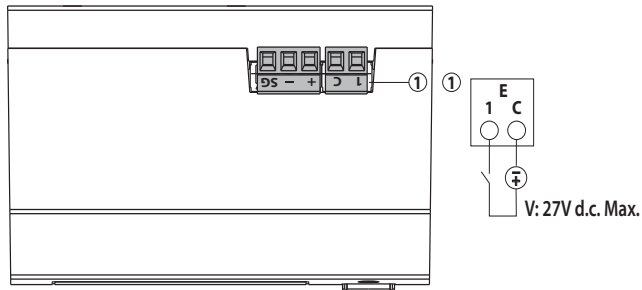

Features of the ModBus communication port:

- Programmable addresses: from 1 to 255 (5*)
- Communication speed: 4.8 – 9.6 – 19.2* – 38.4 kbps
- Parity bit: none, even*, odd
- Stop bit: 1
- Galvanically isolated with respect to the measurement inputs
- Standard RS485 3 wires, half-duplex
- Modbus® RTU protocol
- Response time (question/response time-out): ≤ 200ms
- 120Ω terminating resistor inside the instrument (it can be set in the SETUP menu, default value: none*)

Features of the MBus communication port:

- Standard: EN 13757
- Transmission: serial asynchronous
- No. of bit: 8
- Parity bit: fixed even
- Communication speed: 300-600-1.200-2.400*-4.800-9.600bit/s
- No. of primary address: 0*...250
- No. of secondary address: 0*...99,999,999
- Load MBus: 1
- Galvanically isolated with respect to the measurement inputs
- Transferred measurements: see communication protocol

Features of the Impulse output:

- Optorelay with potential-free SPST-NO contact
- Type S0 (IEC/EN62053-31)
- Voltage Uimp: Max. 27V a.c./d.c.
- Current Iimp: Max. 50 mA
- Programmable impulse weight, possible values: 1 – 10* – 100 – 1k – 10k Wh/imp or varh/imp
- Programmable impulse duration, possible values: 50 -100* – 200 – 300 – 400 – 500ms

* Factory setting

7. GENERAL FEATURES

Auxiliary power supply:

- Shunted from the power socket (Self-supplied)

Operating room temperatures:

- Min. = - 25 °C Max. = + 55 °C.

Room storage temperatures:

- Min. = - 25 °C Max. = + 70 °C.

Short-duration overcurrent:

- 30 I_{max} per 10ms

Short circuit current:

- I_{max} (kA): 17,5 (Δt: 7,4msec)
- Energy 0.635 MA²s

Voltage circuit self-consumption:

- Max. 1,5VA three-phase

Current circuit self-consumption:

- Max. 1,8W for each phase

Maximum dissipated thermal power for the thermal dimensioning of the panels: ≤ 6W

Protection class:

- Terminal protection index against solid bodies and liquids: IP 20 (IEC/EN 60529).
- Housing protection index against solid bodies and liquids: IP 54 (IEC/EN 60529).

Protection of the device:

- By means of thermal-magnetic circuit breaker

Room: mechanical M1 – electric E2 (according to the directive MID 2014/32/UE)

Housing material: Polycarbonate

Packaged volume: 0,60 dm³.

8. CONFORMITY AND CERTIFICATIONS

Insulation

- Measurement categories: III
- Level of pollution: 2
- Insulation voltage, U_i : 300V, Phase-Neutral

Dielectric rigidity:

- Power supplies/ Outputs: 4kV / 50Hz / 1min
- Housing / Terminals: 4kV / 50Hz / 1min

Pulse:

- Power supplies: 6.3kV / 1.2 – 50 μ sec / 0.5J
- Power supplies/ Outputs: 6.3kV / 1.2- 50 μ s / 0.5J

In compliance with the standards:

- Precision class: Class B active energy (EN 50470-1, -3)
- Precision class: Class 2 reactive energy (EN/IEC 62053-23)
- Electromagnetic compatibility: Tests in accordance with EN/IEC 62052-11 / EN 50470-1, -3
- Precision class according to IEC/EN61557-12

Respecting the environment – Conformity with the CEE directives:

- Conformity with directive 2011/65/EU modified by directive 2015/863 (RoHS 2) which restricts hazardous substances such as lead, mercury, cadmium, hexavalent chromium, brominated flame retardants, polybrominated biphenyls (PBB) and polybrominated diphenyl ethers (PBDE)
- Conformity with directive 91/338/CEE of 18/06/91 and decree 94-647 of 27/07/04
- Conformity with the REACH regulation

Plastic materials:

- Plastic materials without Halogens.
- Part marking according to standards ISO 11469 and ISO 1043.

Packaging:

- Packaging designed and produced in accordance with Decree 98-638 of 07.20.98 and directive 94/62/CE

9. COMMUNICATION

RS485 Modbus wiring diagram:

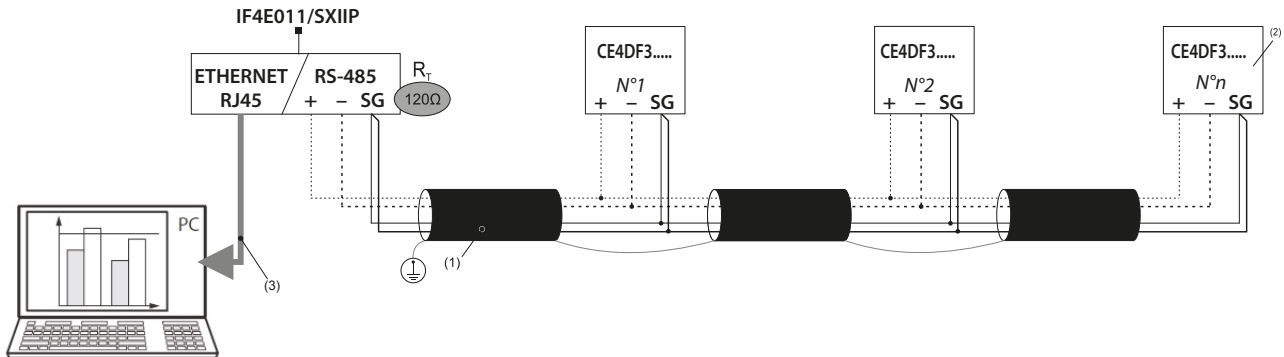

RS485 Modbus wiring diagram with Mini Web Server:

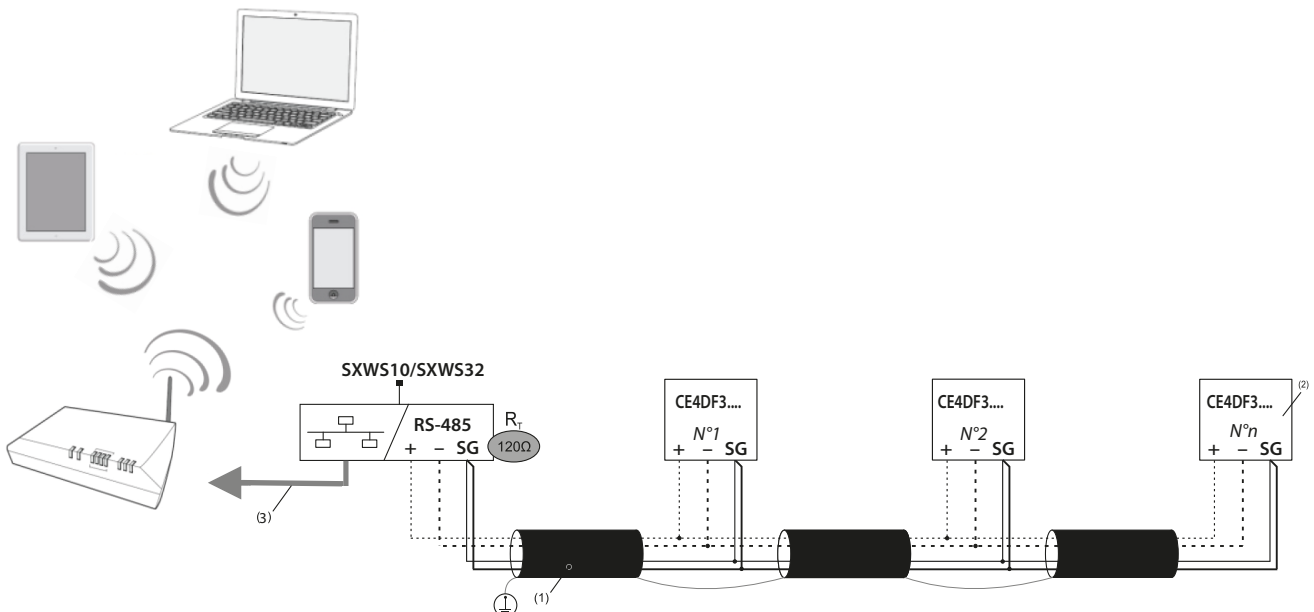

(1) RS485: Required use of Belden 9842 or Belden 3106A wire (or equivalent) for a maximum bus length of 1000 m, or Category 6 wire (FTP or UTP) for a maximum length of 50 m

(2) 120Ω terminating resistor inside the instrument (it can be set in the SETUP menu)

(3) Ethernet: Cat. 6 (FTP/UTP)

Communication tables

- The MODBUS and MBUS communication protocols are available on the <http://www.imeitaly.com>, site, entering the codes: "CE4DF3DTMID / CE4DF3MTMID" in the search field.