

**63A single-phase energy meter,  
 MID direct connection**

Codes: **CE2DF30PMID – CE2DF3DTMID – CE2DF3MTMID**  
 Model: **CONTO D2**



Contents	Pages
1. Use .....	1
2. Range .....	1
3. Installation .....	1
4. Dimensions .....	1
5. Connections .....	2
6. Operating data .....	2
7. General features .....	3
8. Conformity and certifications .....	6
9. Communication .....	7

**1. USE**

Single-phase active and reactive energy meter with direct connection. The device, in 2 DIN modules, is self-powered and is equipped with ModBus or MBus communication or pulse output and double tariff input.

**MID certification**

**2. RANGE**

Code Art.	Model	Connection	Weight
CE2DF30PMID	Pulse	Screw terminals	0,130Kg
CE2DF3DTMID	Double tariff ModBus		
CE2DF3MTMID	Double tariff MBus		

**3. INSTALLATION**

**Fixing:**

On EN/IEC 60715 symmetric rail or DIN 35 rail.

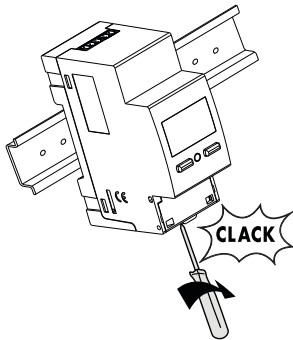

**Necessary tools:**

For fastening the device on the DIN rail: 5.5 mm flat screwdriver (from 4 to 6 mm).

**Operating position:**

Vertical, Horizontal, Upside down, On the side



**4. DIMENSIONS**

**Housing: 2 DIN43880 modules**

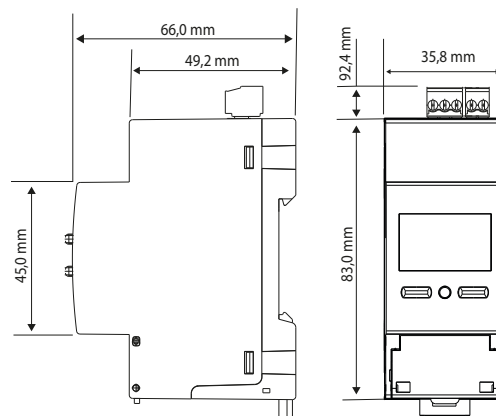

# 63A single-phase energy meter, MID direct connection

Codes: CE2DF30PMID – CE2DF3DTMID – CE2DF3MTMID  
Model: CONTO D2

## 5. CONNECTIONS

Wiring diagrams:

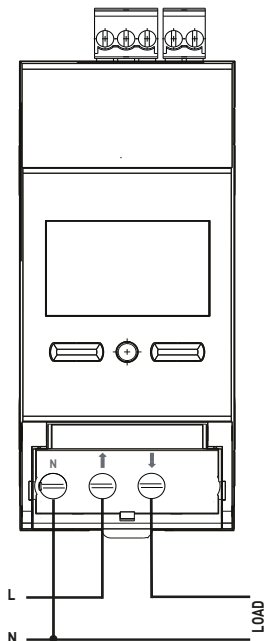

Terminal board marking and diagram combination:

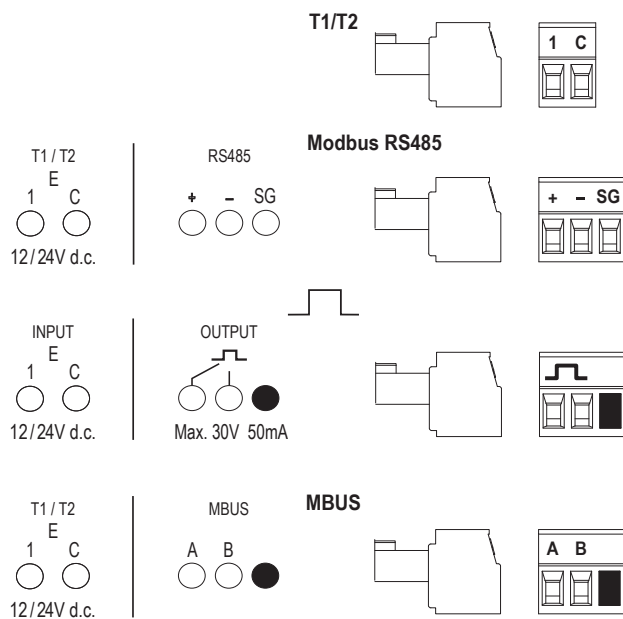

## 6. OPERATING DATA

### 6.1 ELECTRIC DATA

#### Currents:

- Reference current,  $I_{ref}$ : 10A
- Minimum current,  $I_{min}$ : 0,5A
- Maximum current,  $I_{max}$ : 63A

#### Rated voltages:

- Single-phase rated voltage  $U_n$ : 230V  $\pm$ 15%

#### Rated frequency:

- $F_n$ : 50Hz; 60Hz
- Permitted variation: 49...51Hz; 59...61Hz

#### Connectable section:

- Copper wires
- Voltage connection terminals, neutral:

	Without bush	With bush
Rigid wire	1 x 0,75 + 16 mm <sup>2</sup>	-
Flexible wire	1 x 0,75 + 10 mm <sup>2</sup>	1 x 4 + 10 mm <sup>2</sup>

- Terminal boards in the upper part of the meter (input, impulse output and bus):

	Without bush	With bush
Rigid wire	1 x 0,2 + 1,5 mm <sup>2</sup>	-
Flexible wire	1 x 0,2 + 1 mm <sup>2</sup>	1 x 0,2 + 1 mm <sup>2</sup>

#### Necessary tools:

- For the voltage connection terminals, neutral: screwdriver with 6mm blade or Pozidriv No. 2
- For the terminal boards in the upper part of the meter (input, impulse output and bus): screws with 2.5mm blade

# 63A single-phase energy meter, MID direct connection

Codes: CE2DF30PMID – CE2DF3DTMID – CE2DF3MTMID  
Model: CONTO D2

## 6.2 MECHANICAL DATA

### Screw terminals:

- Depth of the terminals: 12mm
- Lengths of the wire stripping: 11mm

### Screw head:

- Voltage connection terminals, neutral : screws with countersunk head with hexagon socket and Pozidriv No. 2
- Terminal boards in the upper part of the meter (input, impulse output and bus): screws with countersunk head with hexagon socket

### Recommended torque:

- Voltage connection terminals, neutral: from 1,6 to 2 Nm
- Terminal boards in the upper part of the meter (input, impulse output and bus): 0.2 N/m

### Terminal protection:

- The power terminals are protected with sliding and sealable terminal front covers which are integrated in the device

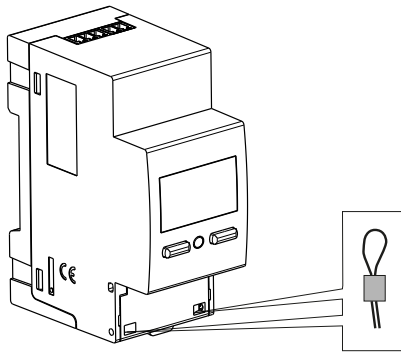

## 7. GENERAL FEATURES (continues)

### Marking data:

Indelible marking

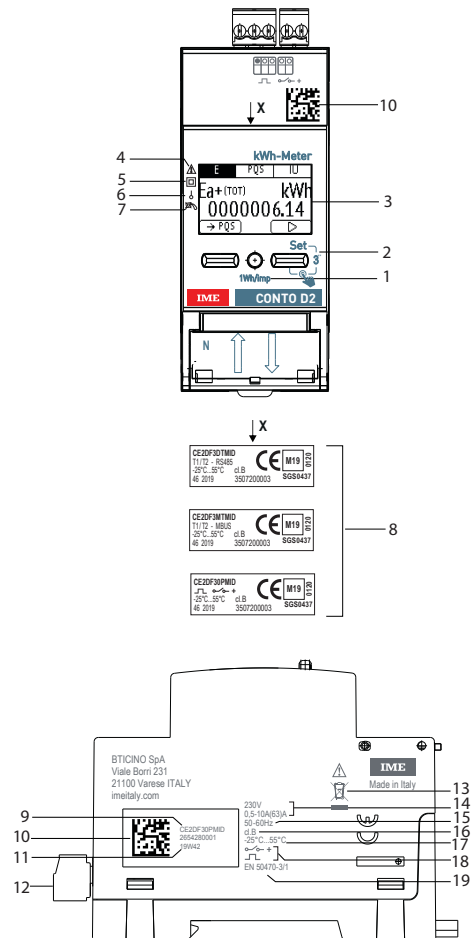

1. Metrological LED
2. Keypad made up of 2 double-function pushbuttons (display/configurations)
3. Graphic display
4. Consult the user manual before installation
5. Double insulation
6. Connection on single-phase line
7. Anti-rotation device (anti-decreasing)
8. MID label
9. Product code
10. Datamatrix for product traceability
11. Week and year of manufacture
12. Output connection terminals
13. RAEE Symbol
14. Voltage / Current
15. Frequency
16. Precision class
17. Temperature of use
18. Outputs
19. MID standard

**63A single-phase energy meter,  
MID direct connection**

Codes: CE2DF30PMID – CE2DF3DTMID – CE2DF3MTMID  
Model: CONTO D2

**7. GENERAL FEATURES**

**Laser marking**

**Left side**  
Traceability information

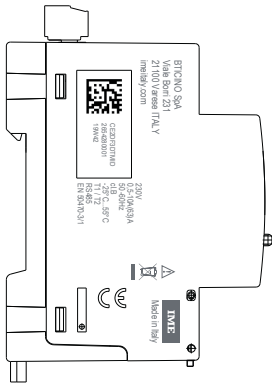

**Right side**  
Wiring diagram

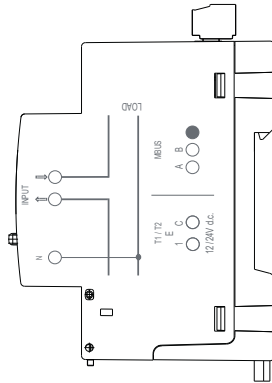
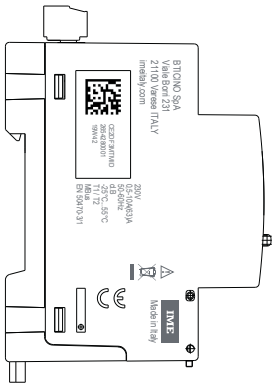
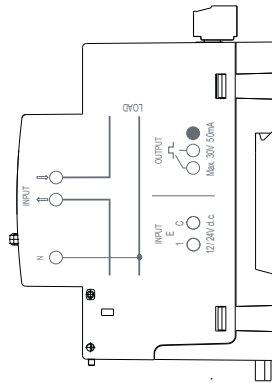
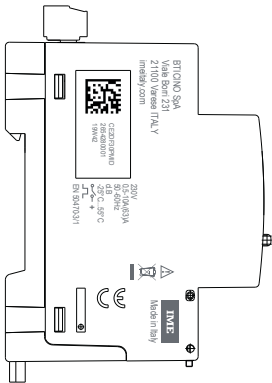
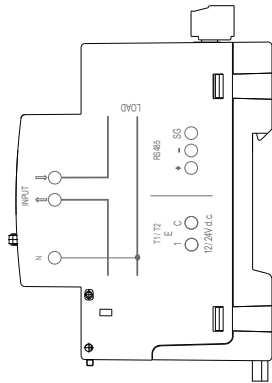

**7. GENERAL FEATURES (continues)**

**Display:**

- Graphic, backlit, 1.2 inches (128x64).

**Resolution:**

- Total meters: 0,01kWh/kvarh
- Partial meters: 0,01kWh/kvarh
- Tariff meters: 0,01kWh/kvarh

**Maximum indication**

- Total meters: 9 999 999,99
- Partial meters: 9 999 999,99
- Tariff meters: 9 999 999,99

**Metrological LED:** 1Wh/imp.

**Display of the value and programming:**

- By means of the front keypad, 2 pushbuttons.
- Change protected by identification code (**predefined code 1000**); the code can be changed during the programming procedure.

**Measurements and precision in conformity with EN/IEC 61557-12**

- Current: cl.0,5
- Voltage: cl.0,5
- Frequency:  $\pm 0,01$  Hz
- Instantaneous total active power, phase, average value and max. average value cl.1
- Instantaneous total active power, phase, average value and max. average value: cl.1
- Instantaneous total reactive power, phase: cl.2
- Instantaneous total apparent power, phase: cl.1
- Power Factor: cl.1

**Average power:**

- Measurement: active power
- Calculation: moving average, on the selected period
- Average time: 5/8/10/15/20/30/60 min.

**Hour meter:**

- Counting of operating hours and minutes (**resettable meter**)
- Resolution: 7 figures (5 for the hours + 2 for the minutes)
- Maximum display: 99 999.59 (tariff total)
- Programmable value: 0...50% Pn (positive)

## 63A single-phase energy meter, MID direct connection

Codes: CE2DF30PMID – CE2DF3DTMID – CE2DF3MTMID  
Model: CONTO D2

### 7. GENERAL FEATURES

#### Digital input

- The digital input allows switching the energy counting on 2 tariffs
- 2 input terminals with common point (1 - C)
- Rated voltage: 12 – 24V d.c. max. 10mA

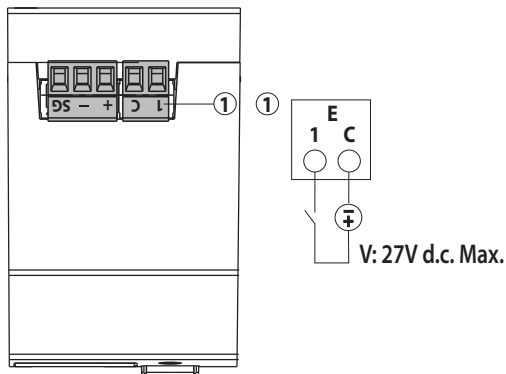

#### Features of the ModBus communication port:

- Programmable addresses: from 1 to 255 (5\*)
- Communication speed: 4.8 – 9.6 – 19.2\* – 38.4 kbps
- Parity bit: none, even\*, odd
- Stop bit: 1
- Galvanically isolated with respect to the measurement inputs
- Standard RS485 3 wires, half-duplex
- Modbus® RTU protocol
- Response time (question/response time-out): ≤ 200ms
- 120Ω terminating resistor inside the instrument (it can be set in the SETUP menu, default value: none\*)

#### Features of the MBus communication port:

- Standard: EN 13757
- Transmission: serial asynchronous
- No. of bit: 8
- Parity bit: fixed even
- Communication speed: 300-600-1.200-2.400\*-4.800-9.600bit/s
- No. of primary address: 0\*...250
- No. of secondary address: 0\*...99,999,999
- Load MBus:1
- Galvanically isolated with respect to the measurement inputs
- Transferred measurements: see communication protocol

#### Features of the Impulse output:

- Optorelay with potential-free SPST-NO contact
- Type S0 (IEC/EN62053-31)
- Voltage  $U_{imp}$ : Max. 27V a.c./d.c.
- Current  $I_{imp}$ : Max. 50 mA
- Programmable impulse weight, possible values:  
1 – 10\* – 100 – 1k – 10k Wh/imp or varh/imp
- Programmable impulse duration, possible values:  
50 -100\* – 200 – 300 – 400 – 500ms

#### \* Factory setting

### 7. GENERAL FEATURES

#### Auxiliary power supply:

- Shunted from the power socket (Self-supplied)

#### Operating room temperatures:

- Min. = - 25 °C Max. = + 55 °C.

#### Room storage temperatures:

- Min. = - 25 °C Max. = + 70 °C.

#### Short-duration overcurrent:

- 30  $I_{max}$  per 10ms

#### Short circuit current:

- $I_{max}$  (kA): 17,5 ( $\Delta t$ : 7,4msec)
- Energy 0.635 MA<sup>2</sup>s

#### Voltage circuit self-consumption:

- Max. 1,5VA

#### Current circuit self-consumption:

- Max. 1,8W

#### Maximum dissipated thermal power for the thermal dimensioning of the panels: ≤ 4W

#### Protection class:

- Terminal protection index against solid bodies and liquids: IP 20 (IEC/EN 60529).
- Housing protection index against solid bodies and liquids: IP 54 (IEC/EN 60529).

#### Protection of the device:

- By means of thermal-magnetic circuit breaker

**Room:** mechanical M1 – electric E2 (according to the directive MID 2014/32/UE)

**Housing material:** Polycarbonate

**Packaged volume:** 0,192 dm<sup>3</sup>.

## 8. CONFORMITY AND CERTIFICATIONS

### Insulation

- Measurement categories: III
- Level of pollution: 2
- Insulation voltage,  $U_i$ : 300V, Phase-Neutral

### Dielectric rigidity:

- Power supplies/ Outputs: 4kV / 50Hz / 1min
- Housing / Terminals: 4kV / 50Hz / 1min

### Pulse:

- Power supplies: 6.3kV / 1.2 – 50 $\mu$ sec / 0.5J
- Power supplies/ Outputs: 6.3kV / 1.2- 50 $\mu$ s / 0.5J

### In compliance with the standards:

- Precision class: Class B active energy (EN 50470-1, -3)
- Precision class: Class 2 reactive energy (EN/IEC 62053-23)
- Electromagnetic compatibility: Tests in accordance with EN/IEC 62052-11 / EN 50470-1, -3
- Precision class according to IEC/EN61557-12

### Respecting the environment – Conformity with the CEE directives:

- Compliance with the 2100/65/EU Directive, as modified by the 2015/863 Directive (RoHS 2), on the restriction of the use of certain hazardous substances in electrical and electronic equipment.
- Conformity with the REACH Regulation (1907/ 2006): at the date of publication of this document no substance in the annex XIV is found in these products.
- RAEE Directive (2012/19/EU): the sale of this product includes a contribution to the appointed environmental bodies of each European country in charge of handling, at the end of their life, the products falling within the scope of the EU Directive on Electric and Electronic Equipment Waste.

### Plastic materials:

- Plastic materials without Halogens.
- Part marking according to standards ISO 11469 and ISO 1043.

### Packaging:

- Packaging designed and produced in accordance with Decree 98-638 of 07.20.98 and directive 94/62/CE

## 9. COMMUNICATION

### RS485 Modbus wiring diagram:

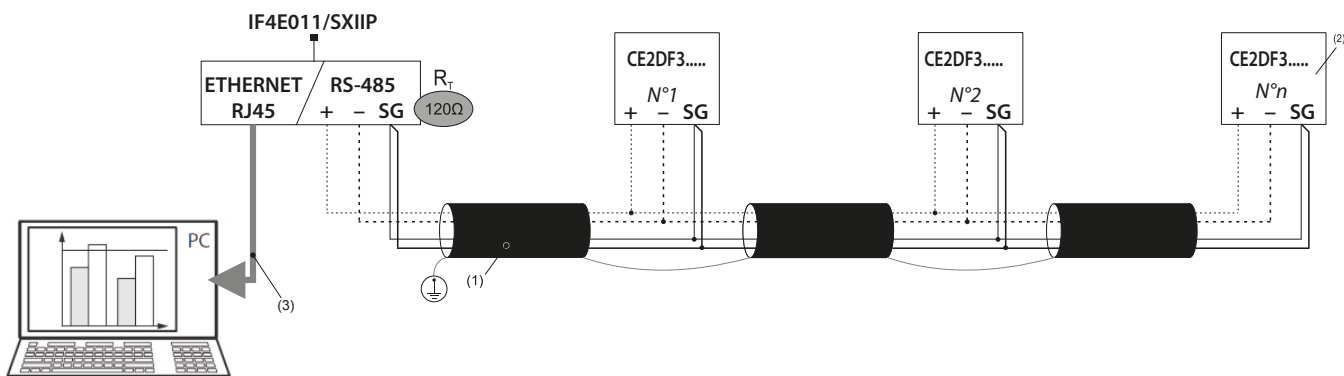

### RS485 Modbus wiring diagram with Mini Web Server:

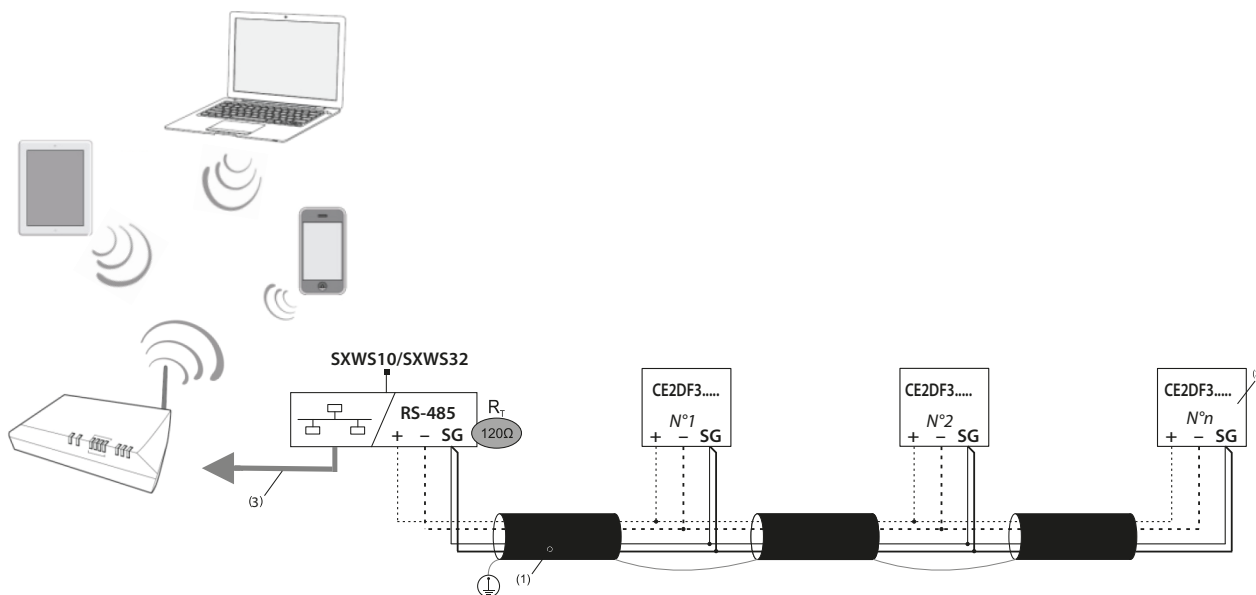

(1) RS485: Required use of Belden 9842 or Belden 3106A wire (or equivalent) for a maximum bus length of 1000 m, or Category 6 wire (FTP or UTP) for a maximum length of 50 m

(2) 120Ω terminating resistor inside the instrument (it can be set in the SETUP menu)

(3) Ethernet: Cat. 6 (FTP/UTP)

### Communication tables

- The MODBUS and MBUS communication protocols are available on the <http://www.imeitaly.com>, site, entering the codes: "CE2DF3DTMID / CE2DF3MTMID" in the search field.