

# Product Data sheet

Part no.	Name	Type
1372821	Self-Tapping Screws S-M SF-PH-M4,2x25 (36-PH) PG	S-M SF-PH-M4,2x25 (36-PH)

Description: Self-Tapping Screws. M4.2 size.

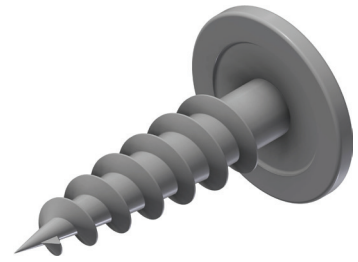

Additional information: Up to 3 mm steelplate. STD: 100

## Characteristics

Name	Value
Weight (kg)	0.0
Dt Diameter threads (mm)	M4,2
Lt Length Threads (mm)	25
Spanner Size SS (mm)	PZ2
K Bolt Head Height (mm)	2.1
L Length (mm)	25

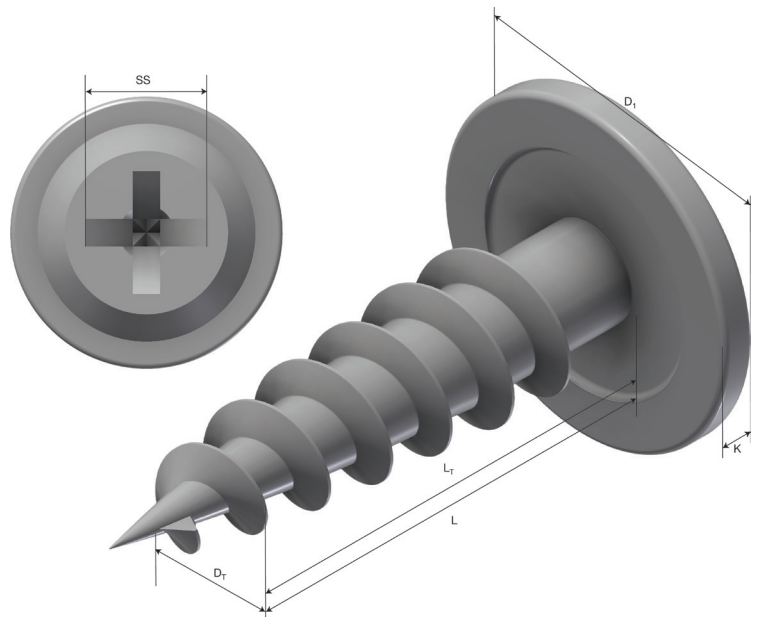

## Product packaging information

F-PAK GTIN	Single piece	
------------	--------------	--