

Product Data sheet

Part no.	Name	Type
1372213	Cable Tray SPBE-20-500 PG	SPBE-20-500

Description: Cable Tray for tubing and light electrical support.

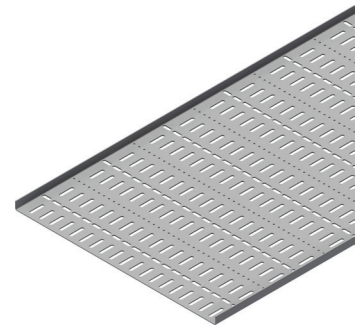

Additional information: Epoxy coated and special treatments on request.

Characteristics

Name	Value
Weight (kg)	22.2
CC (mm)	25
CC1 (mm)	75
CC2 (mm)	150
A Hole Size (mm)	7x35
B Hole Size (mm)	7x35
C Hole Size (mm)	7x35
T Material Thickness (mm)	2
L Length (mm)	3000
W1 Width 1 (mm)	500
H Height (mm)	20

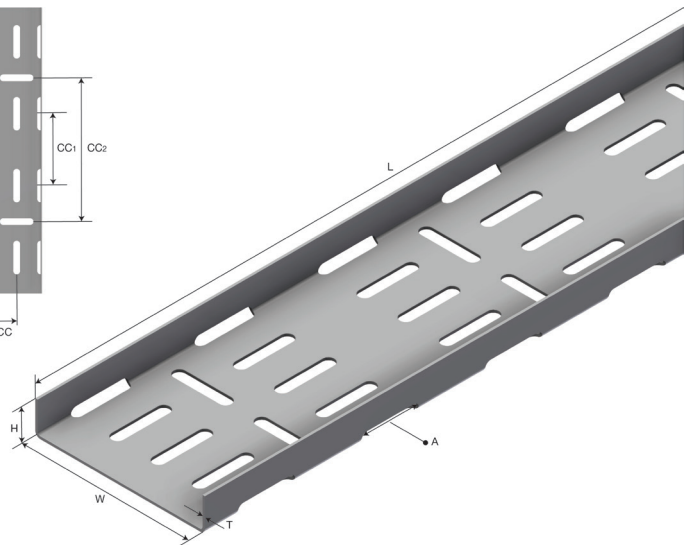
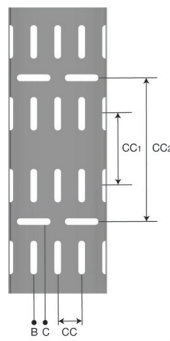

Product packaging information

F-PAK GTIN	Single piece	
------------	--------------	--