

# Product Data sheet

Part no.	Name	Type
1372201	Cable Tray SPBE-20-50 PG	SPBE-20-50



Description: Cable Tray for tubing and light electrical support.

Additional information: Preslotted holes for self tapping screws. Epoxy coated and special treatments on request.

## Characteristics

Name	Value
Weight (kg)	2.8
CC (mm)	25
CC1 (mm)	75
CC2 (mm)	150
A Hole Size (mm)	7x35
B Hole Size (mm)	7x35
C Hole Size (mm)	7x35
T Material Thickness (mm)	1.5
L Length (mm)	3000
W1 Width 1 (mm)	50
H Height (mm)	20

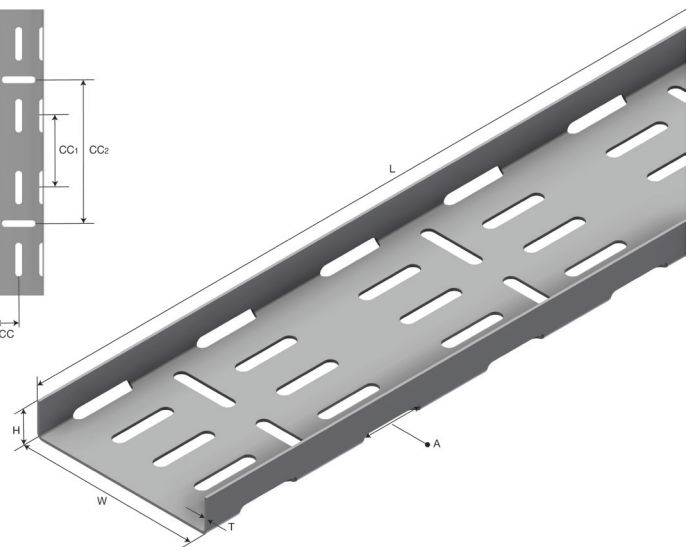
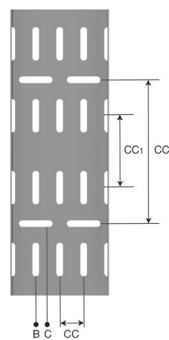

## Product packaging information

F-PAK GTIN	Single piece	
------------	--------------	--