

Product Data sheet

Part no.	Name	Type
1372166	Pan Head Screws S-M PS-M6x30 PG	S-M PS-M6x30

Description: Pan head screws. M6 size.



Additional information: With Torx T30. STD: 200

Characteristics

Name	Value
Weight (kg)	0.008
D1 Diameter (mm)	12
Dt Diameter threads (mm)	M6
Lt Length Threads (mm)	30
Spanner Size SS (mm)	T30
K Bolt Head Height (mm)	4.6
L Length (mm)	30

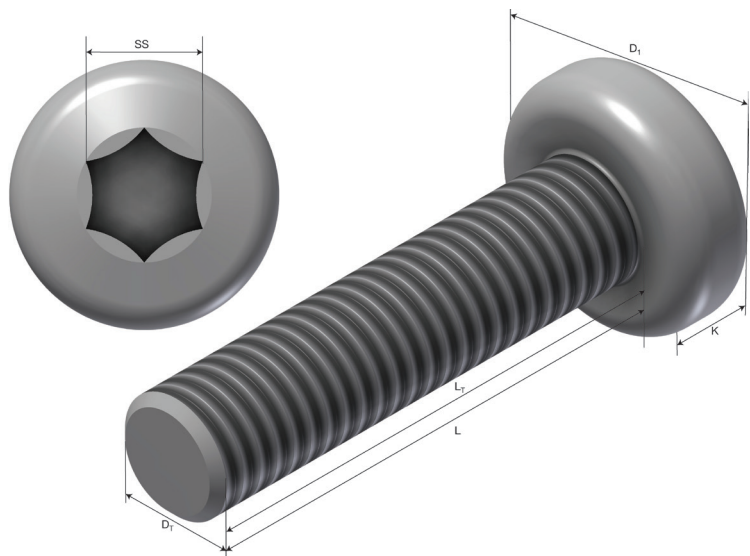

Product packaging information

F-PAK GTIN	Single piece	
------------	--------------	--