

# Product Data sheet

Part no.	Name	Type
1372126	Central Support S-LOE/TOE CS-40U-300 HDG	S-LOE/TOE CS-40U-300

Description: Bracket for Central Support.

1372126 consists of



Part no.
85456

Additional information: Fix ladder to bracket with 2 pc. of screws which order separately. For LOE-55 and LOE-75, 2 pc. M6x12. For LOE-100 and TOE-100, 2 pc. M10x20.

## Characteristics

Name	Value
Weight (kg)	0.7
A Hole Size (mm)	11x51
B Hole Size (mm)	7x20
C Hole Size (mm)	11x20
T Material Thickness (mm)	2.5
X (mm)	312
Y (mm)	43
Z (mm)	98

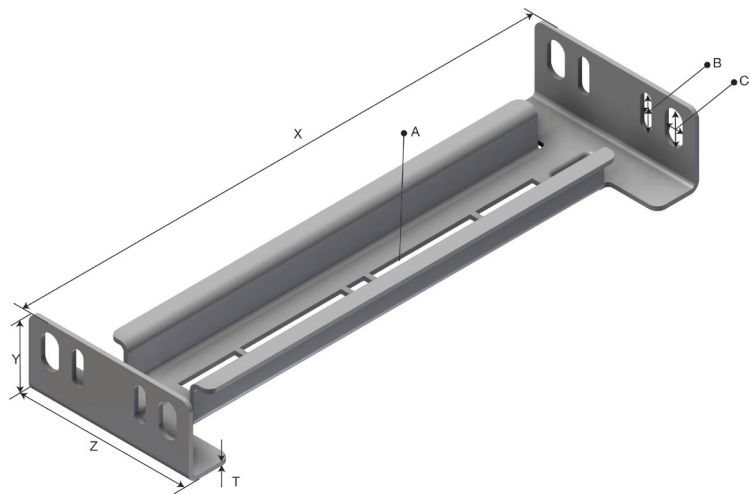

## Product packaging information

F-PAK GTIN	Single piece	
------------	--------------	--