

Product Data sheet

Part no.	Name	Type
1371837	Flat Elbow 90° for Tubing Installations SPBE20 BE-TI-150 SS	SPBE20 BE-TI-150

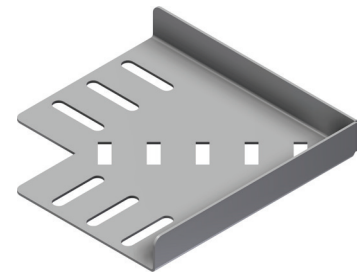

Description: 90° Flat Elbow with integrated splice connectors for tubing installations.

1371837 consists of

Part no.	Name
81182	ELBOW 90DEG SPBE 20-150 SS
1371981	LOCKING BOLT SET S-M M6x12 A4

Additional information:

Characteristics

Name	Value
Weight (kg)	0.5
W Width (mm)	152
T Material Thickness (mm)	1.5
H Height (mm)	21
A Angle (deg)	90
R Radius (mm)	65
X (mm)	197
Y (mm)	197

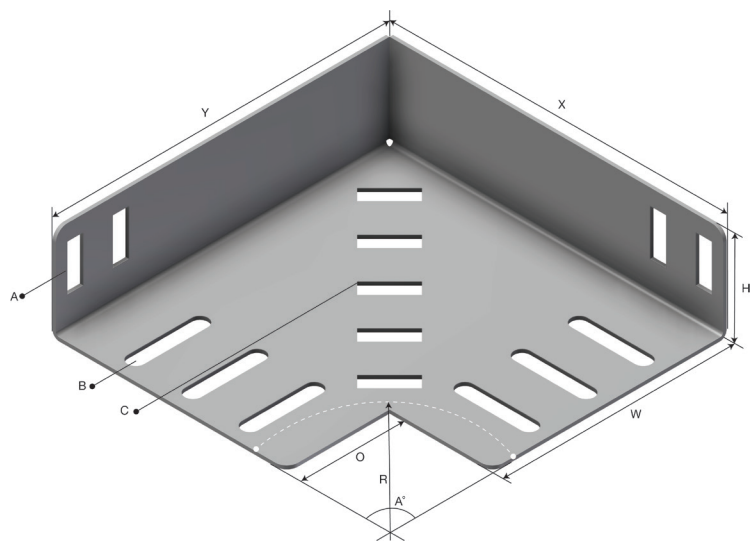

Product packaging information

F-PAK GTIN	Single piece	
------------	--------------	--