

Product Data sheet

Part no.	Name	Type
1371796	Wall Support Bracket S-SPB SB-135-SHS-100 SS	S-SPB SB-135-SHS-100

Description: Support bracket for Cable Trays that can be mounted to a Square Hollow Section (SHS) in combination with a U-bolt or directly on a wall.

1371796 consists of

Part no.	Name
87637	WALL BRACKET SPB135-SHS-100 SS
1371981	LOCKING BOLT SET S-M M6x12 A4

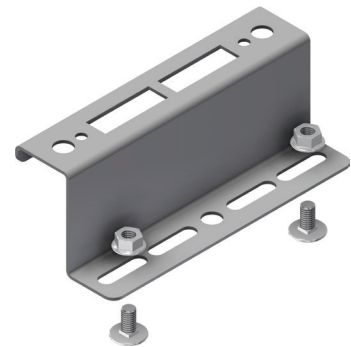

Additional information:

Characteristics

Name	Value
Weight (kg)	0.2
S Spacing (mm)	30
CC (mm)	111
CC1 (mm)	28
CC2 (mm)	44
F Flange (mm)	25
A Hole Size (mm)	Ø9
B Hole Size (mm)	Ø5
C Hole Size (mm)	11x35
D Hole Size (mm)	7x25
T Material Thickness (mm)	1.5
X (mm)	135
Y (mm)	50
Z (mm)	55

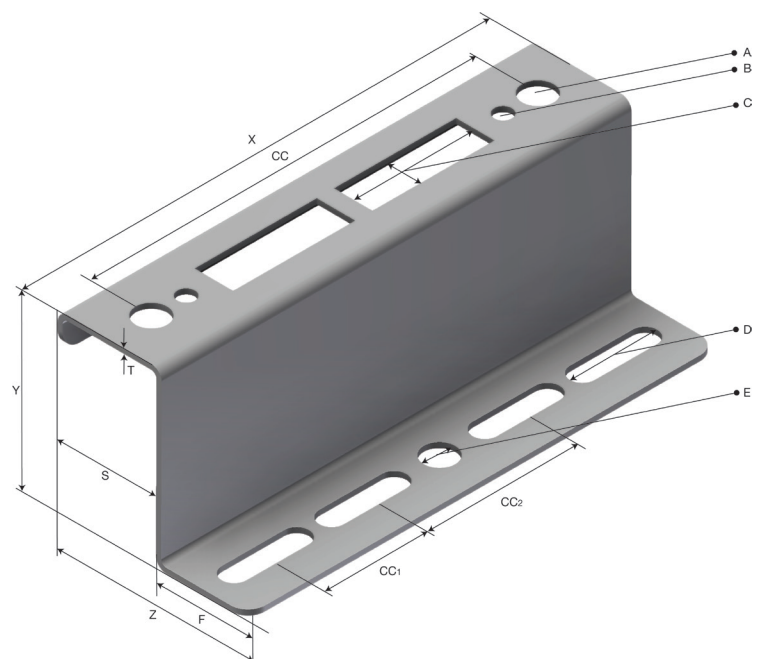

Product packaging information

F-PAK GTIN	Single piece	
------------	--------------	--