

Product Data sheet

Part no.	Name	Type
1371740	Cable Tray SPBE-40-50 HDG	SPBE-40-50

Description: Light Cable Tray mainly for tubing installations, electrical and instrumentation.

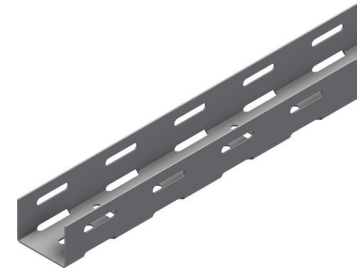

Additional information: Epoxy coating or other surface treatments on request. For products requiring the Entela label, use the regular part number and add the letter «C» at the end.

Characteristics

Name	Value
Weight (kg)	4.3
CC (mm)	25
CC1 (mm)	75
CC2 (mm)	150
A Hole Size (mm)	7x35
B Hole Size (mm)	7x35
C Hole Size (mm)	7x35
T Material Thickness (mm)	1.5
L Length (mm)	3000
W1 Width 1 (mm)	50
H Height (mm)	40

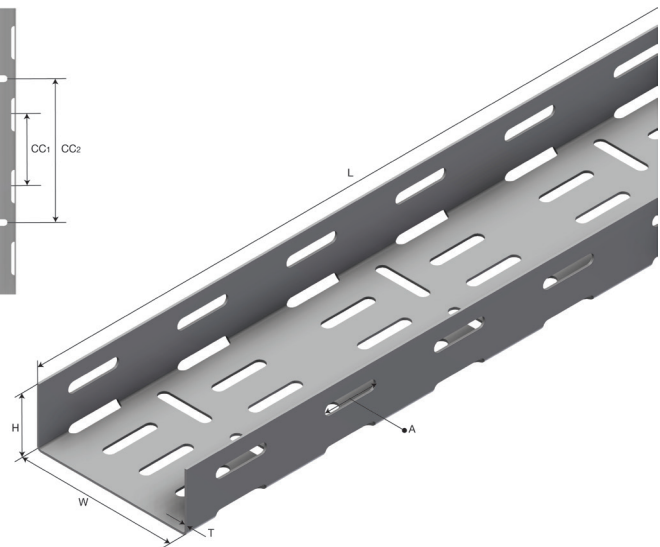
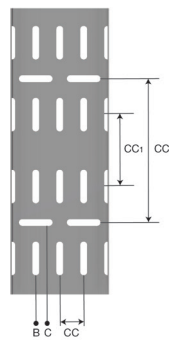

Product packaging information

F-PAK GTIN	Single piece	
------------	--------------	--