

# Product Data sheet

| Part no. | Name                      | Type        |
|----------|---------------------------|-------------|
| 1371413  | Cable Tray SPBE-20-400 SS | SPBE-20-400 |

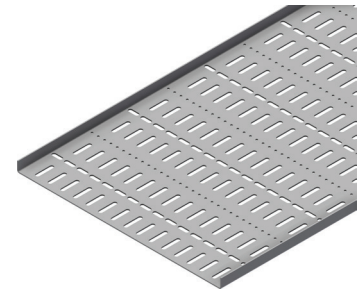

Description: Cable Tray for tubing and light electrical support.

Additional information: Epoxy coated and special treatments on request. For products requiring the Entela label, use the regular part number and add the letter «C» at the end.

## Characteristics

| Name                      | Value |
|---------------------------|-------|
| Weight (kg)               | 13.6  |
| CC (mm)                   | 25    |
| CC1 (mm)                  | 75    |
| CC2 (mm)                  | 150   |
| A Hole Size (mm)          | 7x35  |
| B Hole Size (mm)          | 7x35  |
| C Hole Size (mm)          | 7x35  |
| T Material Thickness (mm) | 1.5   |
| L Length (mm)             | 3000  |
| W1 Width 1 (mm)           | 400   |
| H Height (mm)             | 20    |

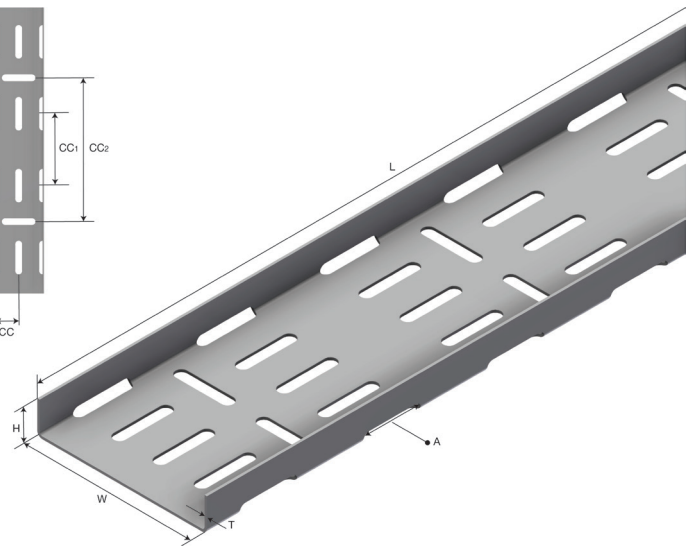
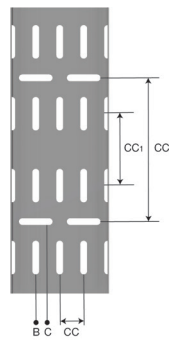

## Product packaging information

|            |              |  |
|------------|--------------|--|
| F-PAK GTIN | Single piece |  |
|------------|--------------|--|