

Product Data sheet

Part no.	Name	Type
1371409	Cable Tray SPBE-20-100 SS	SPBE-20-100

Description: Cable Tray for tubing and light electrical support.

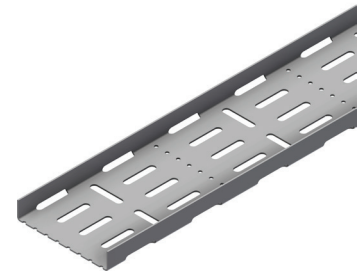

Additional information: Epoxy coated and special treatments on request. For products requiring the Entela label, use the regular part number and add the letter «C» at the end.

Characteristics

Name	Value
Weight (kg)	4.3
CC (mm)	25
CC1 (mm)	75
CC2 (mm)	150
A Hole Size (mm)	7x35
B Hole Size (mm)	7x35
C Hole Size (mm)	7x35
T Material Thickness (mm)	1.5
L Length (mm)	3000
W1 Width 1 (mm)	100
H Height (mm)	20

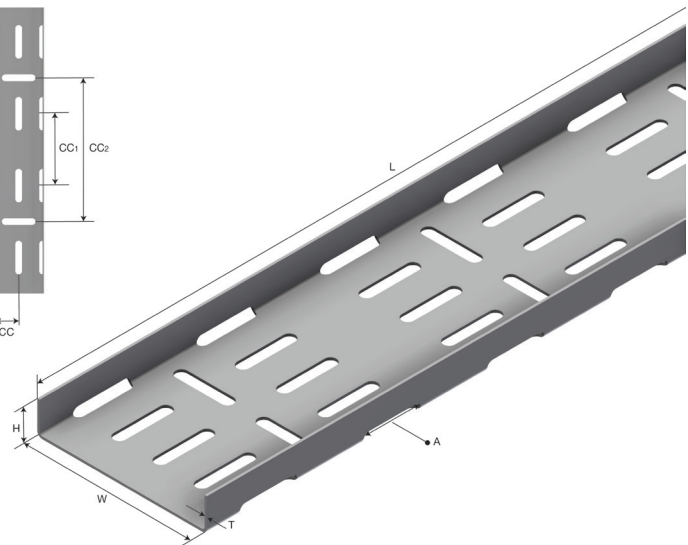
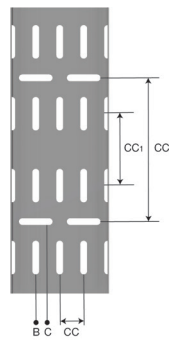

Product packaging information

F-PAK GTIN	Single piece	
------------	--------------	--