

Product Data sheet

Part no.	Name	Type
1371356	Star Washers S-M SW-M8 A4	S-M SW-M8



Description: NORSOK requirements prohibit the use of Star Washers for installation of cable trays & ladders, therefore we recommend our A4 self-lock flange nuts.

Additional information: STD: 100

Characteristics

Name	Value
Weight (kg)	0.001
D1 Diameter (mm)	14
D2 Diameter (mm)	8.2
T Material Thickness (mm)	2.4

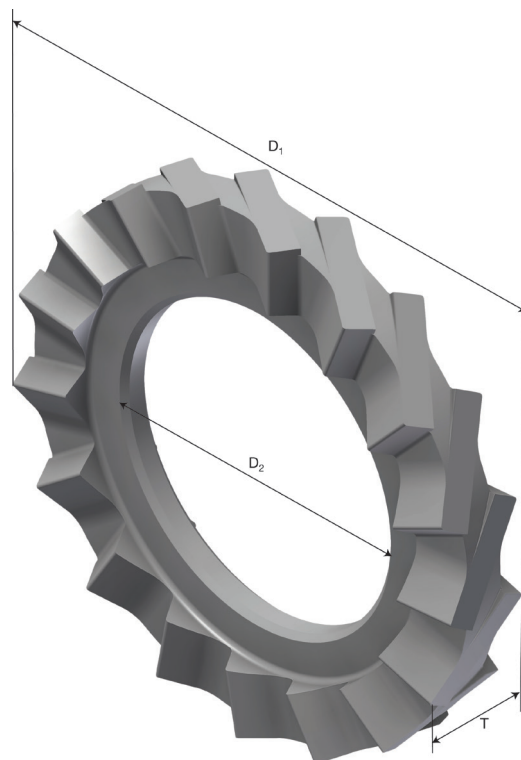

Product packaging information

F-PAK GTIN	Single piece	
------------	--------------	--