

Product Data sheet

Part no.	Name	Type
1371355	Star Washers S-M SW-M6 A4	S-M SW-M6

Description: NORSOK requirements prohibit the use of Star Washers for installation of cable trays & ladders, therefore we recommend our A4 self-lock flange nuts.



Additional information: STD: 200

Characteristics

Name	Value
Weight (kg)	0.001
D1 Diameter (mm)	11
D2 Diameter (mm)	6.4
T Material Thickness (mm)	2.1

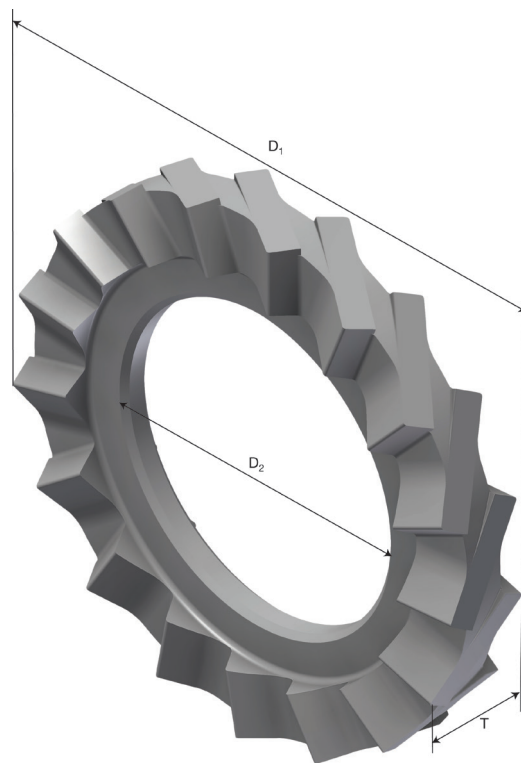

Product packaging information

F-PAK GTIN	Single piece	
------------	--------------	--