

Product Data sheet

Part no.	Name	Type
1302096	Flexi Riser SPBE-20FR-200 SS	SPBE-20FR-200

Description: Flexi Riser with integrated splice connectors.



Additional information: Bend to 30°, 45°, 90° or any other desired angle. Adjust to required angle and fix, no need for splice connector. This flexible part replaces all inside and outside risers. Fixed risers on request.

Characteristics

Name	Value
Weight (kg)	0.8
W Width (mm)	200
B Hole Size (mm)	7x30
A Hole Size (mm)	7x35
C Hole Size (mm)	7x20
Overlap Integrated Splice (mm)	90
H Height (mm)	20
T Material Thickness (mm)	1.5
A Angle (deg)	0°-90°
R Radius (mm)	105
X (mm)	71.In- 112.Out
Y (mm)	71.In- 112.Out

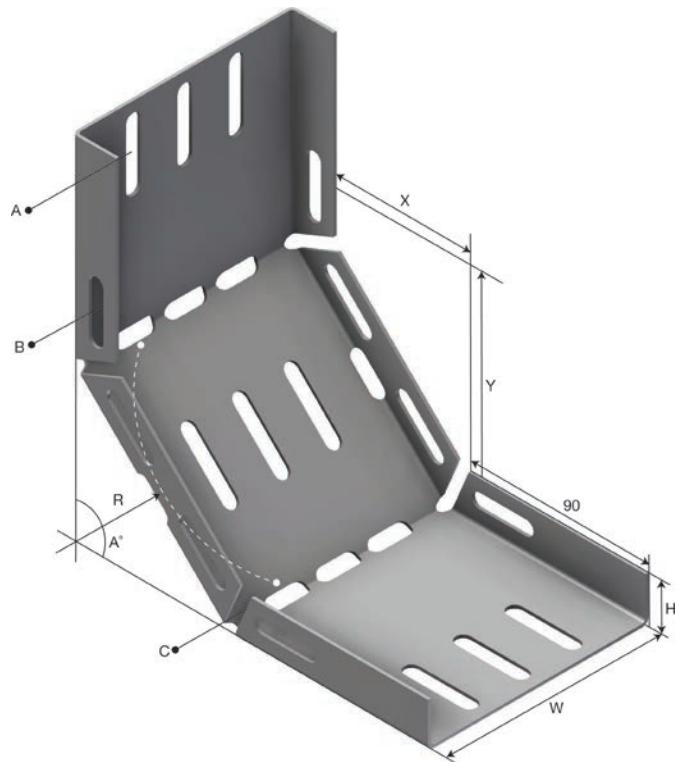

Product packaging information

F-PAK GTIN	Single piece	 7070693020961
D-PAK GTIN		