

# Product Data sheet

Part no.	Name	Type
1302093	Flexi Riser SPBE-20 FR-50 SS	SPBE-20 FR-50

**Description:** Flexi Riser with integrated splice connectors.



**Additional information:** Bend to 30°, 45°, 90° or any other desired angle. Adjust to required angle and fix, no need for splice connector. This flexible part replaces all inside and outside risers. Fixed risers on request.

## Characteristics

Name	Value
Weight (kg)	0.3
W Width (mm)	50
B Hole Size (mm)	7x30
A Hole Size (mm)	7x35
C Hole Size (mm)	7x20
Overlap Integrated Splice (mm)	90
H Height (mm)	20
T Material Thickness (mm)	1.5
A Angle (deg)	0°-90°
R Radius (mm)	105
X (mm)	71.In- 112.Out
Y (mm)	71.In- 112.Out

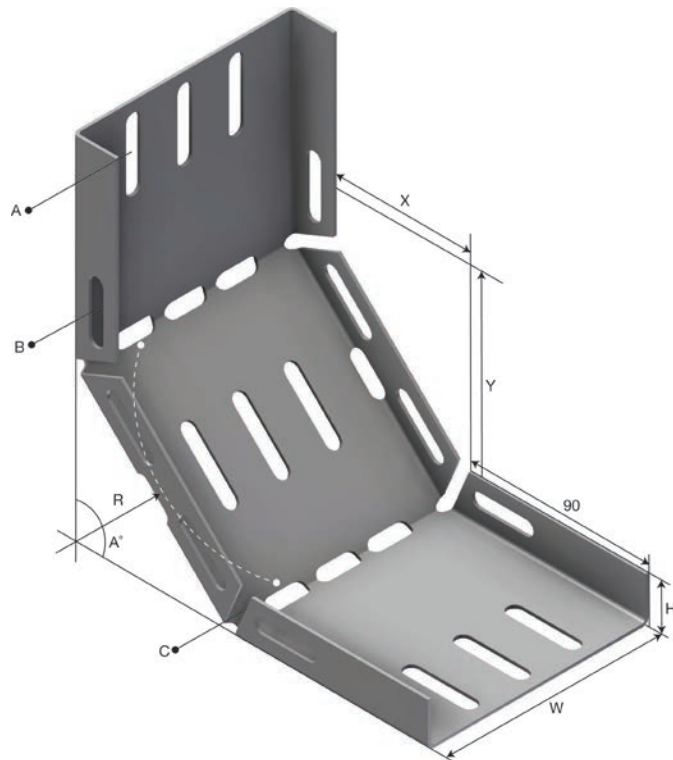

## Product packaging information

<b>F-PAK GTIN</b>	<b>Single piece</b>	 7070693020930
<b>D-PAK GTIN</b>		