

# Terminal Boxes

## Series 8146



www.stahl.de



03098E00

- > Enclosures in shock-resistant glass fibre reinforced polyester resin
- > 8 basic enclosure sizes with various heights
- > Fitted according to the customer's requirements
- > For terminals up to max. 300 mm<sup>2</sup>
- > With captive cover screws
- > Degree of protection IP66

E3



The terminal boxes of the Series 8146, made of high-quality, glass fibre reinforced polyester resin is ideally suitable for the use in rough operating conditions. Due to the reduced surface resistance, the enclosures correspond to the requirements for hazardous areas. Eight basic enclosure sizes having different heights allow the user a variety of application options. The terminal boxes are fitted to order with terminals up to a size of 300 mm<sup>2</sup>. Upon request, flanges can be mounted on several sides of the enclosure.

	ATEX / IECEx							NEC 505							NEC 500					
	0	1	2	20	21	22		Zone	Class I			Class II			Division	Class I		Class II		Class III
8146/1 (Ex e): For use in	x	x			x	x	8146/1 (Ex e): For use in	x	x					8146/1 (Ex e): For use in	x		x	x		
8146/2 (Ex i): For use in	x	x			x	x	8146/2 (Ex i): For use in	*)	*)					8146/2 (Ex i): For use in	x		x	x		

\*) Approval not required

**WebCode 8146A**

# Terminal Boxes

## Series 8146

**Selection Table** for terminal boxes up to max. 35 mm<sup>2</sup>

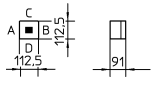
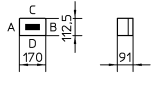
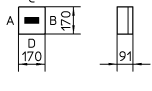
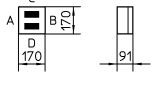
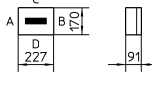
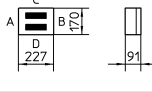
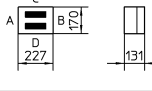
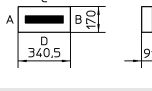
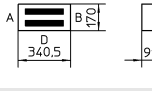
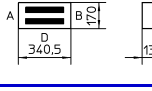
Nominal cross-section [mm <sup>2</sup> ]	Max. number of terminal blocks which can be fitted												Order number	Weight [kg]	
	2.5	4	6	10	16	35									
Arrangements	UK 3 N	WDU 2,5	MXK 4	UK 5 N	WDU 4	UK 6 N	WDU 6	UK 10 N	WDU 10	UK 16 N	WDU 16	UK 35	WDU 35		without / with flange
 08621E00	6	--	--	--	--	--	--	--	--	--	--	--	--	<b>8146/.031</b>	0.64
 08830E00	14	--	12	12	--	--	--	--	--	--	--	--	--	<b>8146/.041</b>	0.81
 08829E00	19	19	16	16	16	11	12	9	9	8	--	--	--	<b>8146/.051</b>	0.85/ 0.95
 08828E00	--	--	28	--	--	--	--	--	--	--	--	--	--	<b>8146/.051</b>	1.05/ 1.15
 08827E00	27	28	23	23	24	17	17	13	14	11	--	--	--	<b>8146/.061</b>	1.06/ 1.26
 08826E00	--	--	46	--	--	--	--	--	--	--	--	--	--	<b>8146/.061</b>	1.10/ 1.30
 08825E00	--	--	46	--	--	--	--	--	--	--	--	--	--	<b>8146/.062</b>	1.50/ 1.70
 08824E00	49	51	--	41	42	31	31	24	25	20	--	--	--	<b>8146/.S71</b>	1.04/ 1.70
 08823E00	--	--	82	--	--	--	--	--	--	--	--	--	--	<b>8146/.S71</b>	1.80/ 2.20
 08822E00	--	--	82	--	--	--	--	--	--	--	--	--	--	<b>8146/.072</b>	1.90/ 2.20
<b>Order Number Supplement:</b>															
	Version:	Ex e										<b>8146/1...</b>			
		Ex i										<b>8146/2...</b>			
<b>Specify with order:</b>	Terminal blocks:	Number and type													
	Cable glands:	Number, type and installation side in enclosure													
	Flanges:	Flanges can be fitted to order; please indicate the side on which they are to be fitted.													
<b>Note:</b>	The order numbers contain the enclosure with carrier rails and PE or PA rail.														
	Terminal boxes fitted with terminals > 35 mm <sup>2</sup> up to 300 mm <sup>2</sup> on request.														

# Terminal Boxes

## Series 8146



**Selection Table** for terminal boxes up to max. 35 mm<sup>2</sup>

Nominal cross-section [mm <sup>2</sup> ]	Max. number of terminal blocks which can be fitted														Order number	Weight [kg]
	2.5		4		6		10		16		35					
	UK 3 N	WDU 2,5	MXK 4	UK 5 N	WDU 4	UK 6 N	WDU 6	UK 10 N	WDU 10	UK 16 N	WDU 16	UK 35	WDU 35			
 08821E00	49	51	41	41	42	31	31	24	25	20	20	--	--	<b>8146/.073</b> <b>8146/.S73</b>	1.40/ 1.70	
 08820E00	19	19	--	16	16	11	12	9	9	8	--	--	--	<b>8146/.071</b>	1.60/ 1.90	
 08819E00	51	53	--	43	44	32	33	26	26	21	--	--	--	<b>8146/.081</b>	2.00/ 2.40	
 08818E00	98	102	82	82	84	62	62	48	50	40	--	--	--	<b>8146/.081</b>	2.40/ 2.80	
 08817E00	147	153	123	123	--	--	--	--	--	--	--	--	--	<b>8146/.081</b>	2.80/ 3.20	
 08816E00	98	102	82	82	84	62	62	48	50	40	--	--	--	<b>8146/.082</b>	3.10/ 3.50	
 08815E00	51	53	43	43	44	32	33	26	26	21	22	17	16	<b>8146/.083</b>	2.60/ 3.00	
 08814E00	98	102	82	82	84	62	62	48	50	40	--	--	--	<b>8146/.083</b>	3.00/ 3.40	
<b>Order Number Supplement:</b>																
	Version:	Ex e Ex i										<b>8146/1...</b> <b>8146/2...</b>				
<b>Specify with order:</b>	Terminal blocks:	Number and type														
	Cable glands:	Number, type and installation side in enclosure														
	Flanges:	Flanges can be fitted to order; please indicate the side on which they are to be fitted.														
<b>Note:</b>	The order numbers contain the enclosure with carrier rails and PE or PA rail. Terminal boxes fitted with terminals > 35 mm <sup>2</sup> up to 300 mm <sup>2</sup> on request.															

E3

# Terminal Boxes

## Series 8146

**Selection Table** for terminal boxes up to max. 35 mm<sup>2</sup>

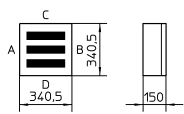
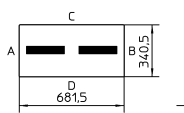
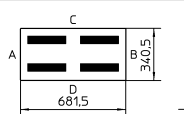
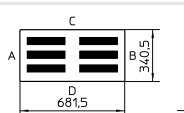
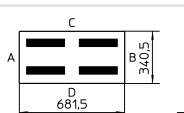
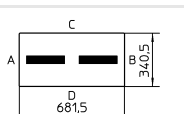
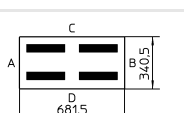
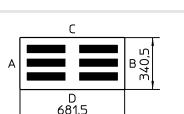
Nominal cross-section [mm <sup>2</sup> ]	Max. number of terminal blocks which can be fitted												Order number	Weight [kg]	
	2.5		4		6		10		16		35				
Arrangements	UK 3 N	WDU 2,5	MXK 4	UK 5 N	WDU 4	UK 6 N	WDU 6	UK 10 N	WDU 10	UK 16 N	WDU 16	UK 35	WDU 35		without / with flange
 08813E00	147	153	123	123	--	--	--	--	--	--	--	--	--	<b>8146/.083</b>	3.40/ 3.80
 08812E00	102	106	86	86	88	64	66	52	52	42	--	--	--	<b>8146/.091</b>	4.00/ 4.80
 08811E00	196	204	164	164	168	124	124	96	100	80	--	--	--	<b>8146/.091</b>	4.80/ 5.60
 08810E00	294	306	246	246	--	--	--	--	--	--	--	--	--	<b>8146/.091</b>	5.20/ 6.00
 08809E00	196	204	164	164	168	124	124	96	100	80	--	--	--	<b>8146/.092</b>	6.00/ 6.80
 08808E00	102	106	86	86	88	64	66	52	52	42	44	34	32	<b>8146/.093</b>	4.60/ 5.40
 08807E00	196	204	164	164	168	124	124	96	100	80	--	--	--	<b>8146/.093</b>	5.40/ 6.20
 08806E00	294	306	246	246	--	--	--	--	--	--	--	--	--	<b>8146/.093</b>	5.80/ 8.60
<b>Order Number Supplement:</b>															
	Version:		Ex e Ex i										<b>8146/1...</b>		
<b>Specify with order:</b>	Terminal blocks:		Number and type										<b>8146/2...</b>		
	Cable glands:		Number, type and installation side in enclosure												
	Flanges:		Flanges can be fitted to order; please indicate the side on which they are to be fitted.												
<b>Note:</b>	The order numbers contain the enclosure with carrier rails and PE or PA rail. Terminal boxes fitted with terminals > 35 mm <sup>2</sup> up to 300 mm <sup>2</sup> on request.														

# Terminal Boxes

## Series 8146



### Explosion Protection

#### Global (IECEX)

Gas and dust	IECEX PTB 06.0046 Ex d e ia/ib [ia Ga] mb IIA, IIB, IIC T6, T5, T4 Gb Ex tb IIIA, IIIB, IIIC, T80°C, T95°C, T130°C Db IP66
--------------	--

#### Europe (ATEX)

Gas and dust	PTB 01 ATEX 1016 ⊕ II 2 G Ex d e ia/ib [ia Ga] mb IIA, IIB, IIC T6, T5, T4 Gb ⊕ II 2 D Ex tb IIIA, IIIB, IIIC T80°C, T95°C, T130°C Db IP66
--------------	--

#### Certifications and certificates

Certificates	IECEX, ATEX, China (China-Ex), Brazil (INMETRO), Canada (CSA), Kazakhstan (GOST K), Korea (KCs), Russia (GOST R), Taiwan (ITRI), Ukraine (TR), Belarus (operating authorisation), USA (UL)
Ship approval	GL, RS

### Technical Data

#### Electrical data

Rated operational voltage	max. 1100 V AC / DC (depending on the terminal type and the explosion protected components that are used)
Rated operational current	max. 500 A (depending on the terminal type and the explosion protected components used)

#### Ambient conditions

Ambient temperature	-60 °C ... +100 °C (depending on the Ex components used)
---------------------	--

#### Mechanical data

Degree of protection	IP66 acc. to IEC/EN 60529
Material	
Enclosure	Polyester resin, glass-fibre-reinforced, dark grey, similar to RAL 7024 Impact resistance $\geq 7$ J Surface resistance $\leq 10^9 \Omega$ Flame-resistant according to IEC/EN 60695, UL 94, ASTM D635
Seal	Standard: foamed silicone Special: PU, foamed (-20 ... +80 °C)
Flanges	
Standard	In the standard design, the enclosures are supplied without flanges.
Option	Depending on order, the enclosures can be fitted on one or more sides with flanges; flange material: polyester resin, glass-fibre-reinforced
Cover lock	with captive M6 stainless steel combo head screws according to the specifications of the terminal block manufacturers
Connection cross-section	
Terminals	Rated cross section which can be used: max. 300 mm <sup>2</sup> . The maximum number of terminals for the respective enclosure size are indicated in the EC type examination certificate.

#### Mounting / Installation

Connection	According to the order directly to the fitted components or to the terminal blocks. The rated operational voltage, the rated operational current and the rated cross section depend on the terminal type used and the explosion protected components.
------------	--

E3

# Terminal Boxes

## Series 8146

### Terminal Box Fittings

Due to contact resistances at the terminals and the cables installed in the enclosure, heat can be caused. In order to ensure that the maximum temperatures of a terminal box are not exceeded, care should be taken that the current load of the circuits installed in the terminal box do not exceed certain values.

The maximum permitted number of conductors for individual terminal boxes, depending on the current load and conductor cross section, can be found in the EC Type Examination Certificate.

**Tables** Terminal box configuration, the number of installable conductors depends on their cross-section and continuous load currents

Enclosure 8146/1041						
Current · Lead cross section [mm <sup>2</sup> ]						
[A]	1,5	2,5	4	6	10	16
3						
6						
10	44					
16	15	29	114			
20	6	17	33			
25		8	18	36		
35			5	14	35	
50				2	11	29
63					3	13
80						5
100						
125						
160						

09702E01

Enclosure 8146/1051						
Current · Lead cross section [mm <sup>2</sup> ]						
[A]	1,5	2,5	4	6	10	16
3						
6						
10	50					
16	17	33	129			
20	7	19	37			
25		9	21	41		
35			6	16	39	
50				2	13	33
63					4	15
80						5
100						
125						
160						

09703E01

Enclosure 8146/1061								
Current · Lead cross section [mm <sup>2</sup> ]								
[A]	1,5	2,5	4	6	10	16	25	35
3								
6								
10	53							
16	18	35	137					
20	7	20	39					
25		9	22	43				
35			6	17	42			
50				2	13	35		
63					4	16	57	
80						6	18	64
100							7	17
125								6
160								
200								
225								
250								

09704E01

Enclosure 8146/1062								
Current · Lead cross section [mm <sup>2</sup> ]								
[A]	1,5	2,5	4	6	10	16	25	35
3								
6								
10	64							
16	22	42	166					
20	9	25	48					
25		11	27	52				
35			8	20	51			
50				3	16	42		
63					5	19	69	
80						7	21	78
100							9	20
125								8
160								
200								
225								
250								

09705E01

Note: Explanations regarding the tables can be found on page 9

# Terminal Boxes

## Series 8146



**Tables** Terminal box configuration, the number of installable conductors depends on their cross-section and continuous load currents

**Enclosure 8146/1071 8146/1S71**  
Current · Lead cross section [mm<sup>2</sup>]

[A]	1,5	2,5	4	6	10	16	25	35
3								
6								
10	55							
16	19	36	142					
20	7	21	41					
25		10	23	45				
35			8	17	44			
50				2	14	36		
63					4	17	60	
80						6	18	67
100							8	17
125								7
160								
200								
225								
250								

09706E01

**Enclosure 8146/1072**  
Current · Lead cross section [mm<sup>2</sup>]

[A]	1,5	2,5	4	6	10	16	25	35	50	70
3										
6										
10	66									
16	22	44	170							
20	9	25	49							
25		12	28	54						
35			8	21	52					
50				3	17	43				
63					5	20	71			
80						7	22	80		
100							9	21		
125								8	21	
160									7	19
200										6
225										2
250										

09707E01

**Enclosure 8146/1073 8146/1S73**  
Current · Lead cross section [mm<sup>2</sup>]

[A]	1,5	2,5	4	6	10	16	25	35	50	70
3										
6										
10	71									
16	24	47	184							
20	10	27	53							
25		13	30	58						
35			8	22	56					
50				3	18	47				
63					6	21	77			
80						8	24	86		
100							10	22		
125								9	23	
160									8	20
200										7
225										2
250										

09708E01

**Enclosure 8146/1081**  
Current · Lead cross section [mm<sup>2</sup>]

[A]	1,5	2,5	4	6	10	16	25	35
3								
6								
10	74							
16	25	49	192					
20	10	29	55					
25		13	31	61				
35			9	23	59			
50				3	19	49		
63					6	22	80	
80						8	25	90
100							10	23
125								9
160								
200								
225								
250								

09709E01

Note: Explanations regarding the tables can be found on page 9

E3

# Terminal Boxes

## Series 8146

**Tables** Terminal box configuration, the number of installable conductors depends on their cross-section and continuous load currents

**Enclosure 8146/1082**  
Current · Lead cross section [mm<sup>2</sup>]

[A]	1,5	2,5	4	6	10	16	25	35	50	70
3										
6										
10	86									
16	29	57	221							
20	12	33	64							
25		15	36	70						
35			10	27	68					
50				4	22	56				
63					7	20	93			
80						10	29	104		
100							12	27		
125								11	28	
160									9	24
200										8
225										3
250										

09710E01

**Enclosure 8146/1083**  
Current · Lead cross section [mm<sup>2</sup>]

[A]	1,5	2,5	4	6	10	16	25	35	50	70
3										
6										
10	91									
16	31	60	235							
20	13	35	68							
25		16	38	74						
35			11	29	72					
50				4	23	60				
63					8	28	99			
80						10	31	111		
100							13	29		
125								11	29	
160									10	26
200										9
225										3
250										

09711E01

**Enclosure 8146/1091**  
Current · Lead cross section [mm<sup>2</sup>]

[A]	1,5	2,5	4	6	10	16	25	35
3								
6								
10	86							
16	29	57	222					
20	12	33	64					
25		16	36	70				
35			10	27	68			
50				4	22	56		
63					7	26	93	
80						10	29	104
100							12	27
125								11
160								
200								
225								
250								

09712E01

Note: Explanations regarding the tables can be found on page 9



# Terminal Boxes

## Series 8146



**Tables** Terminal box configuration, the number of installable conductors depends on their cross-section and continuous load currents

Enclosure 8146/1092															
Current · Lead cross section [mm <sup>2</sup> ]															
[A]	1,5	2,5	4	6	10	16	25	35	50	70	95	120	150	185	240
3															
6															
10	97														
16	33	64	250												
20	13	37	72												
25		18	41	79											
35			12	31	77										
50				4	25	63									
63					8	29	105								
80						11	33	117							
100							14	31							
125								12	31						
160									10	27					
200										10	24	74			
225											3	13	29		
250												7	17	36	
315													3	10	22
400														4	15
500															2

09713E00

Enclosure 8146/1093															
Current · Lead cross section [mm <sup>2</sup> ]															
[A]	1,5	2,5	4	6	10	16	25	35	50	70	95	120	150	185	240
3															
6															
10	102														
16	35	68	263												
20	14	39	76												
25		18	43	83											
35			12	32	81										
50				4	26	67									
63					9	31	110								
80						12	34	123							
100							15	32							
125								13	33						
160									11	29					
200										10	25	78			
225											4	14	30		
250												7	18	38	
315													4	11	23
400														5	16
500															2

09714E01

### Explanations to the table

Each inserted conductor and each internal connection conductor is considered a conductor. Jumpers and earth conductors are not considered.

#### Noncritical area (light area of table)

The light area is noncritical in terms of heating up the enclosure. Circuits classified as being in this area can be incorporated in the enclosure in any number.

#### Critical area (inscribed area of table)

The inscribed area of the table shows the maximum permissible number of conductors considering the cross section of the conductor and the continuous current loading of the conductor. When using this table, simultaneous factors and load factors may be accounted for. Mixed arrangements with circuits of different cross sections and currents are possible. In this case the proportion of the load from the individual circuits should be allowed for on a percentage basis. If a terminal box is fully loaded according to the critical area of the inscribed part of the table, then any number of circuits from the noncritical, light area may be added.

**Dangerous area (dark area of the table)** Terminal boxes which are designed according to this area require an additional temperature-rise test.

# Terminal Boxes

## Series 8146

### Cable Glands

The cable glands are inserted according to the order. The respective holes are punched and the screw connections are fastened by means of counter nuts. Please indicate the entry side!

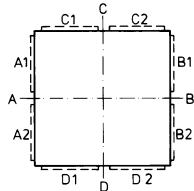

Example:  
8146/.08. cable entry sides

To insert large cables into the enclosures with a height of 150 mm, cable entry plates with strain relief and rubber seals which can be cut out are available.

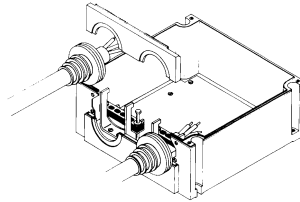

06102E00

Cable entry plate

For metal cable glands, adapter plates can be used.

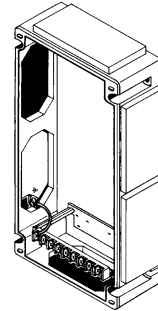

05380E00

Earthing of the metal cable glands by means of brass plates

In the standard version, cable glands made of moulding material, Series 8161, are used.

The opening of the rubber seals can be adapted easily to the diameter of the cable to be entered.

They are mounted at the inner sides of the enclosure walls. This will guarantee the connection to the internal earthing system.

### Cable Entry Flange with Strain Relief for Enclosure Series 8146

#### Application

To insert cables with a large outside diameter into the enclosures of the Series 8146, cable entry flanges can be used. These flanges are separable so that the cables can be inserted from the front side into the flange. A rubber sleeve which is pressed firmly to the cable by means of a hose clamp is used to seal the gap between flange and cable. In the enclosure, the cables are fixed by means of strain reliefs.

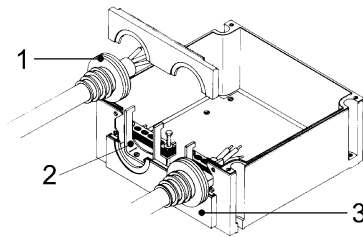

09715E00

- 1) Rubber seal for cable entry flange
- 2) Strain relief
- 3) cable entry flange, separable

#### Assembly

The cable entry flanges must only be mounted on the enclosure sides which point downward. The assembly is carried out in factory. The following enclosures of the Series 8146 can be fitted with cable entry flanges:

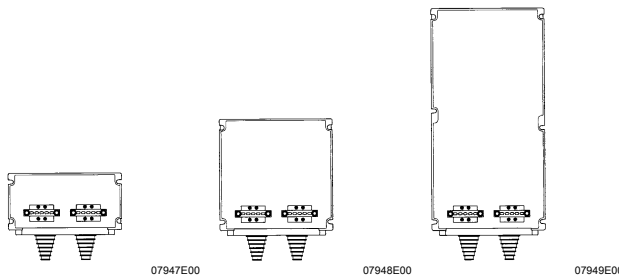

8146/.S73

07947E00

8146/.083  
8146/.085  
8146/.086

07948E00

8146/.093  
8146/.095

07949E00

#### Versions

Cable entry flange fitted with:

Rubber seals	Cable glands	Stopping plugs
2	--	--
2	1 x M20 x 1.5	1 x M25 x 1.5
2	1 x M25 x 1.5	--
2	1 x M20 x 1.5	--
2	1 x M25 x 1.5	--

#### Degree of protection

IP55

#### Rubber seal

black, can be cut out for cable diameters from 20 mm to 60 mm

#### Strain relief

for cable diameters

20 ... 40 mm  
37 ... 64 mm



# Terminal Boxes

## Series 8146



### Max. Number of Cable Glands, Series 8161, to be Mounted

**Attention:**  
The maximum number of cable glands which can be mounted in the enclosure walls depends on the position of the installed mounting rails and components.







Cable gland	Enclosure size																			
 05864E00 Size	8146/.031		8146/.041		8146/.241/.242				8146/.051/.052				8146/.061/.062				8146/.071/.072			
	without flange		without flange		without flange		with flange		without flange		with flange		without flange		with flange		without flange		with flange	
	A/B	C/D	A/B	C/D	A/B	C/D	A/B	C/D	A/B	C/D	A/B	C/D	A/B	C/D	A/B	C/D	A/B	C/D	A/B	C/D
M16 x 1.5	3	6	5	8	5	10	--	7	6	8	--	7	8	10	7	7	8	18	7	14
M20 x 1.5	2	2	3	5	3	7	--	3	4	6	--	3	6	7	3	3	6	14	3	6
M25 x 1.5	1	2	2	4	2	6	--	3	3	5	--	3	5	6	3	3	5	11	3	6
M32 x 1.5	1	1	1	2	1	3	--	2	2	3	--	2	3	3	2	2	3	6	2	4
M40 x 1.5	--	1	1	1	1	2	--	2	1	2	--	2	2	2	2	2	2	4	2	4
M50 x 1.5	--	1	1	1	1	2	--	--	1	1	--	--	1	2	--	--	1	3	--	--
 05864E00 Size	8146/.073/.075				8146/.S71				8146/.S73				8146/.081/.082							
	without flange		with flange		without flange		with flange		without flange		with flange		without flange		with flange					
	A/B	C/D	A/B	C/D	A/B	C/D	A/B	C/D	A/B	C/D	A/B	C/D	A/B	C/D	A/B	C/D				
M16 x 1.5	20	45	12	32	6	20	--	14	13	50	--	32	18	20	14	14				
M20 x 1.5	13	28	9	19	4	16	--	6	9	32	--	19	14	16	6	6				
M25 x 1.5	10	22	6	14	3	13	--	6	8	26	--	14	11	13	6	6				
M32 x 1.5	6	12	4	10	2	7	--	4	4	15	--	10	6	7	4	4				
M40 x 1.5	4	8	2	5	1	5	--	4	2	10	--	5	4	5	4	4				
M50 x 1.5	2	6	1	3	1	4	--	--	1	7	--	3	3	4	--	--				
M63 x 1.5	1	3	1	2	--	--	--	--	1	4	--	2	--	--	--	--				
 05864E00 Size	8146/.083/.085/.086				8146/.091/.092				8146/.093/.095											
	without flange		with flanges		without flange		with flange		without flange		with flange									
	A/B	C/D	A/B	C/D	A/B	C/D	A/B	C/D	A/B	C/D	A/B	C/D								
M16 x 1.5	45	50	32	32	20	38	14	28	50	91	32	64								
M20 x 1.5	28	32	19	19	16	20	6	12	32	60	19	38								
M25 x 1.5	22	26	14	14	13	23	6	12	26	46	14	28								
M32 x 1.5	12	15	10	10	7	12	4	8	15	26	10	20								
M40 x 1.5	8	10	5	5	5	9	4	8	10	18	5	10								
M50 x 1.5	6	7	3	3	4	7	--	--	7	13	3	6								
M63 x 1.5	3	4	2	2	--	--	--	--	4	6	2	4								

E3

# Terminal Boxes

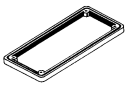
## Series 8146

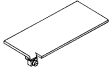
### Accessories and Spare Parts



Designation	Figure	Description	Art. no.	Weight kg		
Flange		Size 1	2.8 mm thick	<b>135978</b>	0.077	
		Size 1	5.8 mm thick	<b>136032</b>	0.106	
		can be mounted on enclosure		Enclosure side		
		8146/.051	/.052	C / D		
		8146/.061	/.062	A / B / C / D		
			8146/.071	/.072	A / B / C / D	
			8146/.S71		C / D	
			8146/.081	/.082	A / B / C / D	
			8146/.091	/.092	A / B / C / D	
		Size 2	2.8 mm thick	<b>136045</b>	0.210	
		Size 2	5.8 mm thick	<b>136083</b>	0.317	
		can be mounted on enclosure		Enclosure side		
		8146/.073	/.075	C / D		
		8146/.S73		C / D		
			8146/.083	/.085	A / B / C / D	
		8146/.093	/.095	A / B / C / D		
				.086		
	Size 3	2.8 mm thick	<b>136199</b>	0.115		
	Size 3	5.8 mm thick	<b>136237</b>	0.166		
	can be mounted on enclosure		Enclosure side			
	8146/.073	/.075	A / B			
Frames		Size 0	68 x 68 mm	<b>136012</b>	0.014	
		Size 1	68 x 128 mm	<b>135974</b>	0.020	
		Size 2	126 x 266 mm	<b>136031</b>	0.041	
		Size 3	126 x 126 mm	<b>136235</b>	0.027	
Brass plate 2 mm for flanges <sup>1) 2)</sup>		for flange size 1	(68 x 128 mm)	<b>136888</b>	0.040	
		for flange size 2	(126 x 266 mm)	<b>136960</b>	0.220	
		for flange size 3	(126 x 126 mm)	<b>136963</b>	0.120	
Brass plate 3 mm for flanges <sup>1)</sup>		for flange size 1	(68 x 128 mm)	<b>136201</b>	0.200	
		for flange size 2	(126 x 266 mm)	<b>136568</b>	0.100	
		for flange size 3	(126 x 126 mm)	<b>136726</b>	0.320	
Brass plate 2 mm for enclosure <sup>1) 2)</sup>		for enclosure	Enclosure sides			
		8146/.031		C / D	<b>136940</b>	0.040
		8146/.041		A / B		
		8146/.041		C / D	<b>136945</b>	0.060
		8146/.051	/.052	A / B	<b>136914</b>	0.050
		8146/.S71		A / B		
		8146/.051	/.052	C / D	<b>136921</b>	0.070
		8146/.061	/.062	A / B		
		8146/.071	/.072	A / B		
		8146/.061	/.062	C / D	<b>136933</b>	0.080
		8146/.071	/.072	C / D	<b>136927</b>	0.140
		8146/.081	/.082	A / B		
		8146/.091	/.092	C1 / D1		
		8146/.073		A / B	<b>136975</b>	0.140
		8146/.073		C / D	<b>136977</b>	0.270
		8146/.083		A / B		
		8146/.093		C1 / D1		
		8146/.S71		C / D	<b>136950</b>	0.160
		8146/.081	/.082	C / D		
		8146/.091	/.092	A / B		
8146/.S73		A / B	<b>136973</b>	0.100		
8146/.S73		C / D	<b>136979</b>	0.310		
8146/.083		C / D				
8146/.093		A / B				
8146/.091	/.092	C2 / D2	<b>136957</b>	0.160		
8146/.093		C2 / D2	<b>136982</b>	0.310		

# Terminal Boxes

## Series 8146

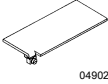

### Accessories and Spare Parts

Designation	Figure	Description	Art. no.	Weight kg	
Brass plate 3 mm for enclosure <sup>1)</sup>		for enclosure	Enclosure sides		
		8146/.031	C / D	<b>136395</b>	0.100
		8146/.041	A / B		
		8146/.041	C / D	<b>136403</b>	0.160
		8146/.041	C / D	<b>136635</b>	0.150
		8146/.051 / .052	A / B	<b>136240</b>	0.140
		8146/.S71	A / B		
		8146/.051 / .052	C / D	<b>136283</b>	0.200
		8146/.061 / .062	A / B		
		8146/.071 / .072	A / B		
		8146/.051 / .052	C / D	<b>136430</b>	0.560
		8146/.061 / .062	A / B		
		8146/.071 / .072	A / B		
		8146/.061 / .062	C / D	<b>136374</b>	0.200
		8146/.071 / .072	C / D	<b>136313</b>	0.400
		8146/.081 / .082	A / B		
		8146/.091 / .092	C 1 / D1		
		8146/.071 / .072	C / D	<b>136451</b>	0.560
		8146/.081 / .082	A / B		
		8146/.073	A / B	<b>136616</b>	0.410
		8146/.073	C / D	<b>136631</b>	0.770
		8146/.073	C / D	<b>136621</b>	0.810
		8146/.083	A / B		
		8146/.093	C1 / D1		
		8146/.S71	C / D	<b>136544</b>	0.460
		8146/.081 / .082	C / D		
8146/.091 / .092	A / B				
8146/.S73	A / B	<b>136611</b>	0.265		
8146/.S73	C / D	<b>136626</b>	0.880		
8146/.083	C / D				
8146/.093	A / B				
Serrated lock washer		for M25 1 pcs.	<b>110706</b>	0.009	
		for M32 1 pcs.	<b>110707</b>	0.007	
		for M40 1 pcs.	<b>110708</b>	0.021	
		for M50 1 pcs.	<b>110709</b>	0.040	
		for M63 1 pcs.	<b>110710</b>	0.060	

1) For earthing metal gland parts when used in moulded plastic enclosures and plastic flanges

- 2) - If the connecting cable is equipped with an armour which is larger than 6 mm<sup>2</sup> and which is used as earthing conductor, a brass plate with a thickness of 3 mm must be used.  
 - Due to the higher strain on the enclosure wall, the 3 mm brass plate has also to be used for large bell mounted glands.

E3

# Terminal Boxes

## Series 8146

Dimensional Drawings (All Dimensions in mm) - Subject to Alterations

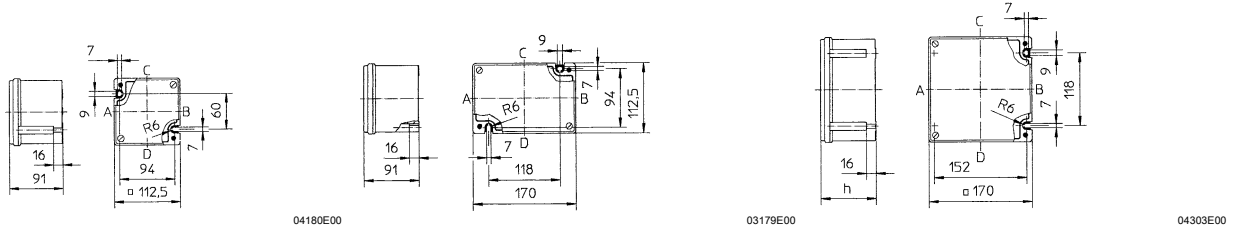

8146/03.

8146/04.

8146/05.

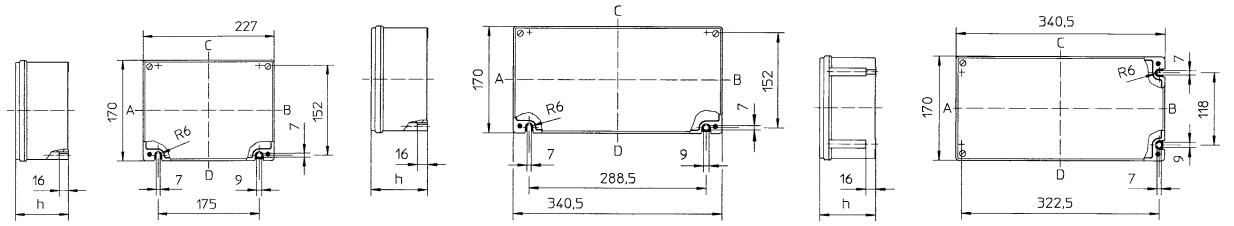

8146/06.

8146/07.

8146/S7.

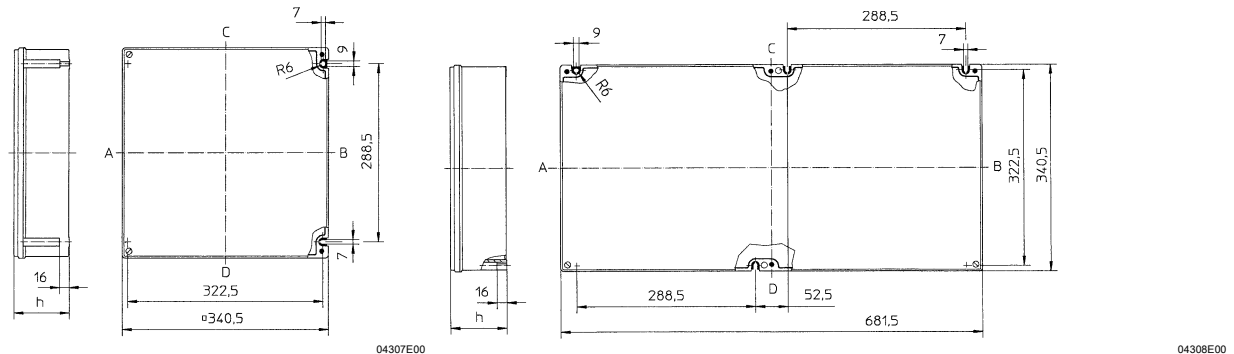

8146/08.

8146/09.

Flange thickness [mm]	Dimension a [mm]
2.8	7
5.8	10

Additional dimension for flange mounting

Enclosure	Enclosure height h				
	8146/...1 91 mm	8146/...2 131 mm	8146/...3 150 mm	8146/...5 190 mm	8146/...6 230 mm
8146/03.	X	-	-	-	-
8146/04.	X	-	-	-	-
8146/05.	X	X	-	-	-
8146/06.	X	X	-	-	-
8146/07.	X	X	X	X	-
8146/S7.	X	-	X	-	-
8146/08.	X	X	X	X	X
8146/09.	X	X	X	X	-

X ... can be supplied

We reserve the right to make alterations to the technical data, dimensions, weights, designs and products available without notice. The illustrations cannot be considered binding.